

**WORKING
DRAFT**

**INCITS XXX
T10/1675D**

Revision 2c
2 February 2006

**INFORMATION TECHNOLOGY -
Multi-Media Commands - 5 (MMC-5)**

This is a draft proposal of the InterNational Committee for Information Technology Standards (INCITS). INCITS is accredited by, and approved under rules approved by, the American National Standards Institute (ANSI). As such this is not a completed standard. The INCITS T10 Technical Committee may modify this document as a result of comments received during public review and its approval as a standard. Use of the information contained herein is at your own risk.

Permission is granted to members of INCITS, its technical committees, and their associated task groups to reproduce this document for the purposes of INCITS standards activities without further permission, provided this notice is included. All other rights are reserved. Any commercial or for-profit replication or re-publication is prohibited.

MMC-5 Technical Editor: Bill McFerrin,
representing Royal Philips
Electronics, NV
P. O. Box 381
Llano, TX 78643
USA

Tel. (325) 423-1560
E-mail: billmc@tstar.net

Reference number
ISO/IEC ***** :XXXX
ANSI INCITS .***** :XXXX
Printed: ***** ,XXXX

This page is intentionally blank

Points of Contact:

T10 Chair

John B. Lohmeyer
LSI Logic Corp.
4420 ArrowsWest Dr.
Colo. Springs, CO 80907-3444

Telephone: (719) 533-7560
Facsimile: (719) 533-7183
Email: lohmeyer@t10.org

T10 Vice-Chair

George O. Penokie
Tivoli Systems Inc.
MS: 2C6
3605 Highway 52 N.
Rochester, MN 55901 USA
Telephone: (507) 253-5208
Facsimile: (507) 253-2880
Email: gpenokie@tivoli.com

INCITS Secretariat
1250 Eye Street, NW Suite 200
Washington, DC 20005

Telephone: 202-737-8888
Facsimile: 202-638-4922
Email: INCITS@itic.org

T10 Web Site www.t10.org

T10 Reflector To subscribe send e-mail to majordomo@T10.org with 'subscribe' in message body
To unsubscribe send e-mail to majordomo@T10.org with 'unsubscribe' in message body
Internet address for distribution via T10 reflector: T10@T10.org

Document Distribution

INCITS Online Store
managed by Techstreet
1327 Jones Drive
Ann Arbor, MI 48105

<http://www.techstreet.com/incits.html>

Telephone: 1-734-302-7801
Toll Free: 1-800-699-9277
Facsimile: 1-734-302-7811

or

Global Engineering
15 Inverness Way East
Englewood, CO 80112-5704

<http://www.ihs.com>

Telephone: 303-792-2181
Toll Free: 800-854-7179
Facsimile: 303-792-2192

Changes from MMCR02B to MMC5R02C

1. Global: Each occurrence of the word “can” was replaced with appropriate alternatives. The word “can” is not permitted by the T10 style guide.
2. Global: In clause 5, most feature descriptions contain one or more tables with columns that require inclusion of links. In clause 6, each command contains a table of recommended error reporting, each with a column of links. The links were added.
3. In sub-clause 2.4, CD references were reordered.
4. In sub-clause 4.2.3.9.1, after figure 17, direct references were changed to ISO format.
5. In figure 18, text in the different columns had lost alignment. Realigned.
6. In sub-clause 4.2.3.9.3, direct references were changed to ISO format.
7. In sub-clause 4.2.3.9.4, direct references were changed to ISO format.
8. In sub-clause 4.2.3.10.2, direct references were changed to ISO format. CD-R media naming was changed from “Orange Book volume 2 media” to “Multi-speed media” and from “Orange Book volume 3 media” to “High Capacity media”.
9. In sub-clause 4.2.4, direct references were changed to ISO format.
10. Sub-clause 4.3.3 was restructured using Mt Fuji as the information basis.
11. Sub-clause 4.3.9.2.2 was deleted. Physical addressing is not different from other DVD types.
12. Sub-clause 4.4.3.1.2 was rewritten according to information provided by Toshiba.
13. Figure 75 was added to show zoning on HD DVD-RAM media.
14. In sub-clause 4.5, 120mm has capacity of 25 GB/layer and 80mm has capacity of 7.8 GB/layer. Other capacities have been removed.
15. Figure 78 was redrawn according to the BD Commands document, 05-206r1.
16. Sub-clauses 4.5.2.3.1 through 4.5.2.3.5 (BD-ROM information zone) were added according to the BD Commands document, 05-206r1.
17. Sub-clause 4.5.3.2.6 was added to describe the BCA on BD-R.
18. In 4.5.3.3.1, TDMA descriptions for SL BD-R were corrected to include effects from the FORMAT UNIT command.
19. In 4.5.3.3.2, TDMA descriptions for DL BD-R were corrected to include effects from the FORMAT UNIT command.
20. Sub-clause “4.5.3.4 TDMA and DMA Usage” was added for descriptive purposes.
21. Sub-clause 4.5.4.3 was restructured to be consistent with the BD Commands document, 05-206r1.
22. Figure 125 was inserted to describe hybrid behavior.
23. Sub-clause 5.3.18, the MRW Feature was updated to permit specification of media support. The new bit descriptions were missing in 2b.
24. Sub-clauses 5.4.16 and 5.4.17 have been added for DVD-R Dual profiles.
25. Sub-clause 6.3.3.8.3 declares that HD DVD-R drives should use the write parameters mode page. Unlike DVD-R, HD DVD-R does not use the write parameters mode page. The statement was removed.
26. Sub-clause 7.2.4 is new, describing the use of mode parameters as described in Fuji and SPC.

ANSI I
INCITS XXX.200n

**American National Standards
for Information Technology –**

SCSI Multi-Media Commands – 5 (MMC-5)

Secretariat
InterNational Committee for Information Technology Standards

Approved DD MM YY

American National Standards Institute, Inc.

Abstract

This standard defines a SCSI based command set needed to access multi-media features. The applicable clauses of this standard when used in conjunction with other standards and publications define a full standard set of commands.

American National Standard

Approval of an American National Standard requires verification by ANSI that the requirements for due process, consensus and other criteria for approval have been met by the standards developer.

Consensus is established when, in the judgment of the ANSI Board of Standards Review, directly and materially affected interests have reached substantial agreement. Substantial agreement means much more than a simple majority, but not necessarily unanimity. Consensus requires that all views and objections be considered and that effort be made towards their resolution.

The use of American National Standards is completely voluntary; their existence does not in any respect preclude anyone, whether he has approved the standards or not, from manufacturing, marketing, purchasing, or using products, processes, or procedures not conforming to the standards.

The American National Standards Institute does not develop standards and in no circumstances give interpretation on any American National Standard. Moreover, no person shall have the right or authority to issue an interpretation of an American National Standard in the name of the American National Standards Institute. Requests for interpretations should be addressed to the secretariat or sponsor whose name appears on the title page of this standard.

CAUTION NOTICE: This American National Standard may be revised or withdrawn at any time. The procedures of the American National Standards Institute require that action be taken periodically to reaffirm, revise, or withdraw this standard. Purchasers of American National Standards may receive current information on all standards by calling or writing the American National Standards Institute.

CAUTION NOTICE: The developers of this standard have requested that holders of patents that may be required for the implementation of this standard disclose such patents to the publisher. However, neither the developers nor the publisher has undertaken a patent search in order to identify, which, if any, patents may apply to this standard. As of the date of publication of this standard and following call for the identification of patents that may be required for the implementation of the standard, no such claims have been made. The developer or publisher in respect to any standard it processes conducts no further patent search. No representation is made or implied that licenses are not required to avoid infringement in the use of this standard.

Published by

**American National Standards Institute
11 West 42nd Street, New York, NY 10036**

Copyright © 200n by American National Standards Institute
All rights reserved.

Printed in the United States of America

Contents

1	Scope	1
2	References.....	3
2.1	Normative References	3
2.2	Approved References	3
2.3	References under development	4
2.4	Other References	4
3	Definitions, Symbols, Abbreviations, and Conventions	7
3.1	MMC General Terms	7
3.2	CD Specific Terms	12
3.3	DVD and HD DVD Specific Terms	15
3.4	BD Specific Terms	18
3.5	Abbreviations and Acronyms	21
3.6	Keywords	23
3.7	Conventions	24
3.8	Bit and byte ordering.....	25
3.9	Notation conventions	25
4	Models.....	27
4.1	General	27
4.1.1	Overview	27
4.1.2	Common Physical Media Structure	27
4.1.2.1	The Disc	27
4.1.2.2	Single Layer Structure.....	28
4.1.2.3	Dual Layer PTP Structure	28
4.1.2.4	Dual Layer OTP Structure.....	29
4.1.2.5	Data Structure in a Spiral	29
4.1.2.5.1	Modulation Coding	29
4.1.2.5.2	Error Detection and Error Correction Coding.....	29
4.1.3	Logical Presentation of the Media	30
4.1.3.1	Logical Blocks	30
4.1.3.2	Logical Sub-Divisions of Media	30
4.1.3.2.1	General	30
4.1.3.2.2	Logical Tracks.....	30
4.1.3.2.2.1	Overview.....	31
4.1.3.2.2.2	Properties of Logical Tracks.....	32
4.1.3.3	Sessions	32
4.1.4	Data cache	33
4.1.5	Resets.....	34
4.1.5.1	Reset Types	34
4.1.5.2	Power-On Reset.....	34
4.1.5.3	Hard Reset	34
4.1.5.4	Device Reset.....	34
4.1.6	Error reporting	34
4.1.6.1	Unit Attention Conditions.....	34
4.1.6.2	Drive Busy Conditions.....	34
4.1.6.3	Unable to Write Errors.....	35
4.1.6.4	Deferred Errors.....	36
4.1.7	Removable medium	36
4.1.8	Drive Ready/Not Ready Conditions	37

4.1.9	Timeouts	39
4.1.9.1	General.....	39
4.1.9.2	Group 1 Timeouts.....	39
4.1.9.3	Group 2 Timeouts.....	40
4.1.9.4	No Timeout Commands	40
4.1.9.5	Group 3 timeout for Real Time Stream Recording/Playback.....	41
4.1.9.5.1	General	41
4.1.9.5.2	Trace time for requested sectors	42
4.1.9.5.3	Exception 1: Time for the initial OPC	42
4.1.9.5.4	Exception 2: Sync cache time.....	42
4.1.9.5.5	Exception 3: Power state transition time to Active state.....	42
4.1.9.5.6	Relationship between Group 3 time unit and Unit length	43
4.1.9.6	Recommended Timeout value handling.....	43
4.1.10	Power Management.....	44
4.2	Compact Disc (CD).....	45
4.2.1	Recorded CD Media Structure.....	45
4.2.1.1	Spiral Structure.....	45
4.2.1.2	The CD Frame Structure	45
4.2.1.3	Sub-channel	46
4.2.2	Physical Track Topology: Single Session Disc.....	48
4.2.3	Physical track topology – Multi-Session Disc	48
4.2.3.1	Sessions.....	48
4.2.3.2	Tracks.....	48
4.2.3.3	Frame Addressing.....	49
4.2.3.4	Q Sub-channel	49
4.2.3.5	Q Sub-channel in the Program Area	50
4.2.3.5.1	Types of Q.....	50
4.2.3.5.2	ADR=1 (0001b) – Mode-1 Q	50
4.2.3.5.3	ADR=2 (0010b) – Mode-2 Q	50
4.2.3.5.4	ADR=3 (0011b) – Mode-3 Q	51
4.2.3.6	Q Sub-channel in the Lead-out Area.....	52
4.2.3.7	Q Sub-channel in the Lead-in Area.....	52
4.2.3.7.1	Types of Q.....	52
4.2.3.7.2	Mode-1 Q	52
4.2.3.7.3	Mode-2 Q	53
4.2.3.7.4	Mode-5 Q	53
4.2.3.8	CD Main Channel Block Formats.....	54
4.2.3.8.1	General Data Block Format	54
4.2.3.8.2	Block Format for Audio	55
4.2.3.8.3	Block Format for Mode 0 Data.....	55
4.2.3.8.4	Block Format for Mode 1 Data.....	55
4.2.3.8.5	Block Format for Mode 2 Data.....	56
4.2.3.8.5.1	Forms of Mode 2	56
4.2.3.8.5.2	Block Format for Mode 2 formless Data.....	56
4.2.3.8.5.3	Block Format for Mode 2 form 1 Data.....	56
4.2.3.8.5.4	Block Format for Mode 2 form 2 Data.....	57
4.2.3.9	CD Recordable and CD ReWritable Media Structure.....	57
4.2.3.9.1	ATIP	57
4.2.3.9.2	ATIP Time Codes.....	59
4.2.3.9.3	Special Information	59
4.2.3.9.4	Additional Information	60
4.2.3.10	Blank Media Structure.....	60
4.2.3.10.1	CD-R Volume 1 and CD-RW	60
4.2.3.10.2	Multi-Speed and High Capacity CD-R	61
4.2.3.10.3	PMA Q Sub-channel	61
4.2.3.11	Recording.....	62

4.2.3.12	The Track Descriptor Block.....	63
4.2.4	High Speed CD-RW media recording.....	65
4.3	DVD Model.....	66
4.3.1	General.....	66
4.3.1.1	Overview.....	66
4.3.1.2	Spiral Structure.....	66
4.3.1.3	ECC Blocks.....	66
4.3.1.3.1	General.....	66
4.3.1.3.2	The Structure of the Data Sector.....	67
4.3.1.3.3	The Structure of the ECC Block.....	67
4.3.1.4	The Lead-in Area.....	68
4.3.2	DVD-ROM.....	71
4.3.2.1	Track Structure.....	71
4.3.2.2	Sector Structure.....	71
4.3.2.3	The Lead-in.....	72
4.3.3	DVD-RAM.....	73
4.3.3.1	General.....	73
4.3.3.2	Physical Track Structure.....	73
4.3.3.3	Sector Structure.....	74
4.3.3.4	The Lead-in.....	75
4.3.3.5	Logical Structure.....	76
4.3.3.6	DVD-RAM Recording.....	76
4.3.4	DVD-R/-RW.....	77
4.3.4.1	Track Structure.....	77
4.3.4.2	Sector Structure.....	77
4.3.4.3	The Lead-in.....	78
4.3.4.3.1	Control Data Zone.....	79
4.3.4.3.2	DVD-R/-RW Physical Format Information Zone.....	80
4.3.4.3.3	Extra Border Zone.....	81
4.3.4.4	DVD-R/-RW Recording.....	82
4.3.4.4.1	RZone Description.....	82
4.3.4.4.2	Border-in/Border-out.....	82
4.3.4.4.3	RMD Caching for RMA Updates.....	82
4.3.5	DVD-R Dual Layer.....	83
4.3.5.1	Introduction.....	83
4.3.5.2	Physical Overview.....	83
4.3.5.3	Logical Overview.....	84
4.3.5.4	Recording on DVD-R Dual Layer.....	85
4.3.5.4.1	RZone (Logical Track).....	85
4.3.5.4.2	RZone Reservation.....	85
4.3.5.4.3	Border Zone.....	86
4.3.5.5	Layer Jump recording.....	87
4.3.5.5.1	Layer Jump Block (LJB).....	87
4.3.5.5.2	Layer Jump Methods.....	88
4.3.5.5.3	Manual Layer Jump.....	88
4.3.5.5.4	Regular Interval Layer Jump.....	88
4.3.5.5.5	Remapping on Layer Jump recording.....	89
4.3.5.6	RZone closing.....	90
4.3.5.7	Disc closing.....	90
4.3.5.8	State of DVD-R Dual Layer disc for ROM compatibility.....	91
4.3.6	DVD+R.....	92
4.3.6.1	Track Structure.....	92
4.3.6.1.1	The ADIP (Address in Pre-groove).....	92
4.3.6.1.2	The ECC Block.....	92
4.3.6.1.3	DVD+R Groove Layout.....	93
4.3.6.2	Recording on DVD+R.....	94

4.3.6.2.1	Recording Structures	94
4.3.6.2.1.1	ECC Blocks	94
4.3.6.2.1.2	Fragments	94
4.3.6.2.1.3	Sessions	95
4.3.6.2.2	The Host's Perspective	97
4.3.6.2.3	Building from a Blank Disc	98
4.3.7	DVD+R Double Layer	99
4.3.7.1	Introduction	99
4.3.7.2	Logical Overview	99
4.3.7.3	The Groove	100
4.3.7.3.1	Logical Disc Layout	100
4.3.7.3.2	ADIP	101
4.3.7.4	Recorded Structure	101
4.3.7.5	Recording on DVD+R DL	102
4.3.7.5.1	Session Structure	102
4.3.7.5.1.1	Sessions	102
4.3.7.5.1.2	Fragments (Logical Tracks)	102
4.3.7.5.2	Single Layer Recording	102
4.3.7.5.3	Double Layer Recording: Crossing the Layers	102
4.3.7.5.4	Finalization	104
4.3.7.5.5	Finalization Time Deferral	104
4.3.7.6	Read-Only Compatibility	105
4.3.8	DVD+RW	106
4.3.8.1	Track Structure	106
4.3.8.1.1	The ADIP (Address in Pre-groove)	106
4.3.8.1.2	Logical Structure	106
4.3.8.2	The ECC Block	106
4.3.8.3	DVD+RW Basic Format	107
4.3.8.3.1	Reading	107
4.3.8.3.2	Writing	108
4.3.8.3.3	Formatting	108
4.3.9	DVD+RW Dual Layer	109
4.3.9.1	Track Structure	109
4.3.9.2	Logical Structure	109
4.3.9.2.1	The ECC Block	109
4.3.9.2.2	Physical Addressing	110
4.3.9.3	Groove Layout	110
4.3.9.3.1	Logical Disc Layout	110
4.3.9.3.2	ADIP	111
4.3.9.4	Using DVD+RW DL Media	111
4.3.9.4.1	Reading	111
4.3.9.4.2	Writing	111
4.3.9.4.3	Formatting	111
4.3.9.4.3.1	Overview	111
4.3.9.4.3.2	Normal Start Formatting	111
4.3.9.4.3.3	Quick Start Formatting	111
4.3.9.4.3.4	Quick Stop	112
4.3.9.4.3.5	Compatibility Stop	112
4.3.9.4.3.6	Restarting	112
4.3.9.5	Background Formatting Methods for DVD+RW DL	113
4.3.9.5.1	Single Layer Formatting	113
4.3.9.5.2	Dual Layer Formatting	114
4.3.10	Disc Control Blocks	115
4.3.10.1	Overview	115
4.3.10.2	Specified DCBs	116
4.3.10.2.1	The DVD+R and DVD+R DL Session DCB (SDCB)	116

4.4	HD DVD Description	117
4.4.1	General	117
4.4.2	Physical Media Characteristics	117
4.4.2.1	The Disc	117
4.4.2.2	Track Structure	118
4.4.3	Logical Structure	118
4.4.3.1	ECC Blocks	118
4.4.3.1.1	The Structure of the Data Sector	118
4.4.3.1.2	The Structure of the ECC Block	119
4.4.3.2	The Lead-in Area	120
4.4.4	HD DVD-ROM	121
4.4.4.1	Track Structure	121
4.4.4.2	Sector Structure	121
4.4.4.3	The Lead-in Area	121
4.4.5	HD DVD-R	122
4.4.5.1	Track Structure	122
4.4.5.2	Sector Structure	122
4.4.5.3	The Lead-in Area	123
4.4.5.4	HD DVD-R Recording	123
4.4.6	HD DVD-RAM	124
4.4.6.1	Track Structure	124
4.4.6.2	Sector Structure	125
4.4.6.3	The Lead-in Area	125
4.4.6.4	HD DVD-RAM Recording	126
4.5	Blu-ray Disc (BD)	127
4.5.1	Overview	127
4.5.1.1	General	127
4.5.1.2	The Spiral	127
4.5.1.3	Logical Blocks, Sectors and Clusters	127
4.5.2	BD-ROM	128
4.5.2.1	Overview	128
4.5.2.2	Track Structure	128
4.5.2.3	The Information Zone	129
4.5.2.3.1	Burst Cutting Area (BCA)	129
4.5.2.3.2	Embossed Zone (tracks at wide pitch)	130
4.5.2.3.3	Inner Zone 0 (Lead-in Zone)/Inner Zone 1 (Lead-out Zone)	130
4.5.2.3.4	Data Zone	130
4.5.2.3.5	Outer Zone 0 (Lead-out Zone)/Outer Zone 1	130
4.5.2.4	Access Model	130
4.5.3	BD-R	131
4.5.3.1	Overview	131
4.5.3.2	Blank Media Structure	131
4.5.3.2.1	Primary Zones	131
4.5.3.2.2	Capacity	131
4.5.3.2.3	ADIP	131
4.5.3.2.4	Un-recorded Sector Addressing	131
4.5.3.2.5	Groove Layout	132
4.5.3.2.6	Burst Cutting Area (BCA)	133
4.5.3.2.7	Pre-recorded Zone	133
4.5.3.2.8	Lead-in Zone (Inner Zone 0)	133
4.5.3.2.9	Data Zone	133
4.5.3.2.10	Outer Zone 0 (Lead-out Zone on a SL disc)	134
4.5.3.3	Logical Structure	134
4.5.3.3.1	Logical Structure of Single Layer BD-R	134
4.5.3.3.2	Logical Structure of Dual Layer BD-R	135
4.5.3.4	TDMA and DMA Usage	136

- 4.5.3.5 BD-R Recording Models 138
 - 4.5.3.5.1 Random Recording Mode (RRM) 138
 - 4.5.3.5.2 Sequential Recording Mode (SRM) 138
 - 4.5.3.5.2.1 General 138
 - 4.5.3.5.2.2 Definitions 138
 - 4.5.3.5.2.3 Logical to Physical Addressing 140
 - 4.5.3.5.2.4 Status after Formatting a Blank BD-R 141
 - 4.5.3.5.2.5 Creating Additional Logical Tracks 141
 - 4.5.3.5.2.6 Creating New Sessions 142
 - 4.5.3.5.3 Defect Management 142
 - 4.5.3.5.4 Pseudo-OverWrite (POW) 142
 - 4.5.3.5.4.1 POW on SRM 142
 - 4.5.3.5.4.2 Orphans 142
 - 4.5.3.5.4.3 Closed Logical Tracks with Blank Clusters 143
 - 4.5.3.6 Examples of SRM and SRM+POW 143
 - 4.5.3.6.1 Initialize the Disc as SRM+POW 143
 - 4.5.3.6.2 Create a Small Logical Track, Write it, and Close it 143
 - 4.5.3.6.3 Split Logical Track 1 144
 - 4.5.3.6.4 Split Logical Track 2 144
 - 4.5.3.6.5 Write to Each Logical Track 145
 - 4.5.3.6.6 POW a Logical Block in Logical Track 1 145
 - 4.5.3.6.7 Complete Writing Logical Track 1, POW LBA = 128 a Second Time 146
 - 4.5.3.6.8 Use Orphaned LBAs via POW 146
 - 4.5.3.6.9 The Expanding Orphanage 147
- 4.5.4 BD-RE 148
 - 4.5.4.1 Overview 148
 - 4.5.4.2 Track Structure 148
 - 4.5.4.3 The Information Zone 150
 - 4.5.4.3.1 Burst Cutting Area 151
 - 4.5.4.3.2 Embossed HFM Zone 151
 - 4.5.4.3.3 Inner Zone 0/Inner Zone 1 (Lead-in Zone/Lead-out Zone) 151
 - 4.5.4.3.4 Data Zone 151
 - 4.5.4.3.5 Lead-out Zone/Outer Zone 0/Outer Zone 1 151
- 4.5.5 Physical Track Structure 152
- 4.5.6 Sectors and Clusters 153
- 4.5.7 Emergency Brake 154
- 4.5.8 Physical Access Control (PAC) 155
 - 4.5.8.1 Overview 155
 - 4.5.8.2 General PAC Format 155
 - 4.5.8.2.1 PAC ID and Format 155
 - 4.5.8.2.2 PAC Update Count 155
 - 4.5.8.2.3 Unknown PAC Rules 155
 - 4.5.8.2.4 Unknown PAC Entire Disc Flags 156
 - 4.5.8.2.5 Segments 156
 - 4.5.8.2.6 Known PAC Entire Disc Flags 156
 - 4.5.8.2.7 PAC specific Information 156
 - 4.5.8.3 Primary PAC 156
 - 4.5.8.3.1 Primary PAC on BD-ROM 156
 - 4.5.8.3.2 Primary PAC on BD-RE 156
 - 4.5.8.4 Disc Write Protect PAC 156
 - 4.5.8.4.1 General 156
 - 4.5.8.4.2 Write Protect Password 157
 - 4.5.8.4.3 Write Protect Control Byte 157
 - 4.5.8.4.4 Virtual Write Enable (VWE) 158
 - 4.5.8.4.5 Changing the Write Protect Password 160
- 4.6 The MRW Format for ReWritable Media 161

4.6.1	Overview	161
4.6.2	Consequences of a Multi-Volume Format	161
4.6.2.1	LBA Spaces.....	161
4.6.2.2	Features and Events	162
4.6.3	Host Requests/Drive Responses.....	162
4.6.3.1	General.....	162
4.6.3.2	Streamed Writing.....	162
4.6.3.3	Formatting	162
4.7	Drive Assisted Software Defect Management.....	163
4.7.1	General	163
4.7.2	Basic actions for defect management.....	163
4.7.3	Software Defect management modes	163
4.7.3.1	General.....	163
4.7.3.2	Persistent defect management (Persistent-DM) mode.....	163
4.7.3.3	Distributed real-time defect management (DRT-DM) mode	163
4.7.4	Enhanced Defect Reporting.....	164
4.7.4.1	General.....	164
4.7.4.2	Standard playback model for DVD-RW media.....	164
4.7.4.3	Four types of defect level	164
4.7.4.4	Error reporting control	165
4.7.4.5	DBI memory management	168
4.7.4.5.1	General	168
4.7.4.5.2	Simple DBI memory model	168
4.7.4.5.3	Large DBI buffer memory model.....	168
4.7.4.5.4	Small DBI cache memory model.....	168
4.7.4.5.4.1	General.....	168
4.7.4.5.4.2	Three types of memory blocks in DBI memory	169
4.7.4.5.4.3	Adjust DBI cache for a real-time application	170
4.7.5	Implicit synchronize cache.....	170
4.7.6	Persistent-DM mode behavior	171
4.7.6.1	General.....	171
4.7.6.2	RECOVERED ERROR reporting control for Persistent-DM mode	171
4.7.6.3	Recommend Host sequence of Persistent-DM mode.....	172
4.7.7	DRT-DM mode behavior	172
4.7.7.1	General.....	172
4.7.7.2	Defect Level Transition model.....	172
4.7.7.3	Certification	173
4.7.7.4	Detecting the use of a defective block	173
4.7.7.5	Management of defective block	173
4.7.7.6	Delayed replacement of data on defective block	174
4.7.7.7	RECOVERED ERROR reporting control for DRT-DM mode.....	174
4.8	Real-Time Stream Recording/Playback Model.....	175
4.8.1	General	175
4.8.2	Real-Time Stream Playback	175
4.8.3	Error Handling with Hardware or No Defect Management	176
4.8.4	Real-Time Stream Recording	176
4.8.5	Error Handling with Hardware or No Defect Management	178
4.8.6	Error Handling with Software Defect Management	178
4.8.7	Fatal error recovery model with Group 3 time-out	178
4.9	Timely Safe Recording (TSR) method.....	180
4.9.1	General	180
4.9.2	Two phase recording	180
4.9.2.1	Phase one – Fast recording and error detection.....	180
4.9.2.2	Phase two – defect management for non-streamed data	181
4.9.3	Phase two – defect management for streamed data	181

4.9.4	Implementation notes for the Drive.....	181
4.9.5	Example of TSR Recording over a Single LBA Range.....	183
4.10	Content Protection.....	186
4.10.1	Overview.....	186
4.10.1.1	General.....	186
4.10.1.2	Block Ciphers.....	186
4.10.1.3	Stream Ciphers.....	186
4.10.1.4	Authentication.....	186
4.10.2	Content-Scrambling System (CSS).....	187
4.10.2.1	General.....	187
4.10.2.2	Authentication.....	187
4.10.3	Content Protection for Recordable Media and Pre-Recorded Media (CPRM/CPPM).....	188
4.10.3.1	General.....	188
4.10.3.2	Authentication.....	188
4.10.4	Video Content Protection for DVD+R/+RW (VCPS).....	188
4.10.4.1	General.....	188
4.10.4.2	Authentication.....	188
4.10.5	Advanced Access Content System (AACCS).....	189
4.10.5.1	General.....	189
4.10.5.2	Authentication.....	189
4.11	Write Protect.....	190
4.11.1	Types of Write Protect.....	190
4.11.2	SWPP.....	191
4.11.3	CWP.....	191
4.11.4	MSWI.....	191
4.11.5	PWP.....	191
4.11.6	WDCB.....	191
4.11.7	DWP PAC.....	191
4.11.8	Event Reporting.....	192
4.11.9	Error reporting.....	192
4.12	Changer Model.....	193
4.12.1	General.....	193
4.12.2	Side definition.....	193
4.12.2.1	Overview.....	193
4.12.2.2	Side Changing Only Drive.....	194
4.12.2.3	Attention Conditions for Sided Discs.....	194
4.12.2.4	Error Conditions for Sided Discs.....	194
4.12.2.5	Initialization.....	195
4.12.3	Changer Addressing.....	196
4.12.4	Automatic Load and Unload Operations.....	196
4.12.5	Delayed Disc load operation.....	196
4.12.6	Prevent / Allow processing.....	197
4.12.7	Error Reporting for Changers.....	197
4.13	Hybrid Discs.....	198
4.13.1	General.....	198
4.13.2	Structure of a Hybrid disc.....	198
4.13.3	Format-layer selection mechanism using the START/STOP UNIT command.....	198
5	Features and Profiles for Multi-Media Devices.....	201
5.1	Introduction.....	201
5.2	Feature and Profile Descriptors.....	201
5.2.1	Overview.....	201
5.2.2	Feature Descriptor.....	202
5.2.2.1	Feature Code.....	202
5.2.2.2	Version field.....	202

5.2.2.3	Persistent Bit	202
5.2.2.4	Current Bit	202
5.2.2.5	Additional Length Field	202
5.2.3	Defined Features	203
5.3	Feature Definitions.....	205
5.3.1	Profile List Feature (0000h)	205
5.3.2	Core Feature (0001h)	207
5.3.3	Morphing Feature (0002h).....	209
5.3.4	Removable Medium Feature (0003h).....	210
5.3.5	Write Protect Feature (0004h).....	212
5.3.6	Random Readable Feature (0010h).....	214
5.3.7	Multi-Read Feature (001Dh).....	216
5.3.8	CD Read Feature (001Eh).....	217
5.3.9	DVD Read Feature (001Fh).....	218
5.3.10	Random Writable Feature (0020h).....	219
5.3.11	Incremental Streaming Writable Feature (0021h)	221
5.3.12	Sector Erasable Feature (0022h)	223
5.3.13	Formattable Feature (0023h).....	224
5.3.14	Hardware Defect Management Feature (0024h).....	226
5.3.15	Write Once Feature (0025h).....	227
5.3.16	Restricted Overwrite Feature (0026h)	229
5.3.17	CD-RW CAV Write Feature (0027h).....	230
5.3.18	The MRW Feature (0028h).....	231
5.3.19	Enhanced Defect Reporting Feature (0029h).....	233
5.3.20	DVD+RW Feature (002Ah).....	236
5.3.21	DVD+R Feature (002Bh)	238
5.3.22	Rigid Restricted Overwrite Feature (002Ch)	239
5.3.23	CD Track at Once Feature (002Dh).....	241
5.3.24	CD Mastering (Session at Once) Feature (002Eh).....	243
5.3.25	DVD-R/-RW Write Feature (002Fh).....	245
5.3.26	Layer Jump Recording Feature (0033h).....	246
5.3.27	CD-RW Media Write Support Feature (0037h).....	247
5.3.28	BD-R Pseudo-Overwrite (POW) Feature (0038h)	248
5.3.29	DVD+RW Dual Layer Feature (003Ah)	249
5.3.30	The DVD+R Double Layer Feature (003Bh).....	251
5.3.31	BD Read Feature (0040h)	253
5.3.32	BD Write Feature (0041h).....	255
5.3.33	TSR Feature (0042h).....	257
5.3.34	HD DVD Read Feature (0050h).....	258
5.3.35	HD DVD Write Feature (0051h).....	259
5.3.36	Hybrid Disc Feature (0080h).....	261
5.3.37	Power Management Feature (0100h).....	262
5.3.38	S.M.A.R.T. Feature (0101h)	263
5.3.39	Embedded Changer Feature (0102h).....	264
5.3.40	Microcode Upgrade Feature (0104h).....	265
5.3.41	Timeout Feature (0105h).....	266
5.3.42	DVD CSS Feature (0106h).....	267
5.3.43	Real Time Streaming Feature (0107h)	268
5.3.44	Drive Serial Number Feature (0108h).....	270
5.3.45	Media Serial Number Feature (0109h).....	271
5.3.46	Disc Control Blocks Feature (010Ah)	272
5.3.47	DVD CPRM Feature (010Bh)	273
5.3.48	Firmware Information Feature (010Ch)	274
5.3.49	AACS Feature (010Dh).....	276
5.3.50	VCPS Feature (0110h).....	277

5.4	Profile Definitions	278
5.4.1	Overview	278
5.4.2	No Current Profile (0000h).....	278
5.4.3	Non-Removable Disk Profile (0001h)	278
5.4.4	Removable Disk Profile (0002h).....	279
5.4.5	Magneto-Optical Erasable Profile (0003h).....	279
5.4.6	Optical Write Once Profile (0004h).....	280
5.4.7	AS-MO Profile (0005h).....	280
5.4.8	Profile 0008h: CD-ROM.....	281
5.4.9	CD-R Profile (0009h)	281
5.4.10	CD-RW Profile (000Ah).....	282
5.4.11	DVD-ROM Profile (0010h).....	282
5.4.12	DVD-R Sequential recording Profile (0011h).....	283
5.4.13	DVD-RAM Profile (0012h)	283
5.4.14	DVD-RW Restricted Overwrite Profile (0013h).....	284
5.4.15	DVD-RW Sequential Recording Profile (0014h).....	284
5.4.16	DVD-RW Dual Layer Sequential Recording Profile (0015h).....	285
5.4.17	DVD-RW Dual Layer Jump Recording Profile (0015h).....	285
5.4.18	DVD+RW Profile (001Ah).....	286
5.4.19	DVD+R Profile (001Bh).....	287
5.4.20	DVD+RW Dual Layer Profile (002Ah).....	288
5.4.21	DVD+R Double Layer Profile (002Bh)	289
5.4.22	BD-ROM Profile (0040h).....	289
5.4.23	BD-R Sequential Recording (SRM) Profile (0041h)	290
5.4.24	BD-R Random Recording (RRM) Profile (0042h).....	291
5.4.25	BD-RE Profile (0043h).....	292
5.4.26	HD DVD-ROM Profile (0050h).....	293
5.4.27	HD DVD-R Profile (0051h).....	293
5.4.28	HD DVD-RAM Profile (0052h)	294
5.4.29	Profile FFFFh: Drives Not Conforming to a Standard Profile	294
6	Commands	295
6.1	Overview	295
6.2	BLANK Command	298
6.2.1	Introduction	298
6.2.2	The CDB and its Parameters	298
6.2.2.1	The CDB.....	298
6.2.2.2	IMMED	298
6.2.2.3	Blanking Type.....	298
6.2.2.4	Start Address/Track Number.....	299
6.2.3	Command Processing.....	301
6.2.4	Timeouts	301
6.2.5	Error Reporting	301
6.3	CLOSE TRACK/SESSION Command.....	302
6.3.1	Introduction	302
6.3.2	The CDB and its Parameters.....	302
6.3.2.1	The CDB.....	302
6.3.2.2	IMMED	302
6.3.2.3	Close Functions.....	302
6.3.2.4	Logical Track Number	302
6.3.3	Command Processing.....	303
6.3.3.1	Close Function Definitions for CD-R/-RW	303
6.3.3.1.1	Reserved Close Functions	303
6.3.3.1.2	Close Function 001b: Close a Logical Track	303
6.3.3.1.3	Close Function 010b: Close Session/Finalize disc	303

6.3.3.2	Close Function Definitions for DVD-R/-RW.....	304
6.3.3.2.1	Reserved Close Functions.....	304
6.3.3.2.2	Close Function 001b: Close a Logical Track.....	304
6.3.3.2.3	Close Function 010b: Close Session.....	304
6.3.3.2.4	Close Function 011b: Finalize the disc.....	304
6.3.3.3	Close Function Definitions for DVD-R DL.....	305
6.3.3.3.1	Reserved Close Functions.....	305
6.3.3.3.2	Close Function 001b: Close a Logical Track.....	305
6.3.3.3.3	Close Function 010b: Close Session.....	305
6.3.3.4	Close Function Definitions for DVD+R.....	306
6.3.3.4.1	Reserved Close Functions.....	306
6.3.3.4.2	Close Function 001b: Close the Logical Track.....	306
6.3.3.4.3	Close Function 010b: Close Session.....	306
6.3.3.4.4	Close Function 101b: Finalize the Disc with minimal radius.....	306
6.3.3.4.5	Close Function 110b: Finalize the Disc.....	306
6.3.3.5	Close Function Definitions for DVD+R DL.....	307
6.3.3.5.1	Reserved Close Functions.....	307
6.3.3.5.2	Close Function 001b: Close a Logical Track.....	307
6.3.3.5.3	Close Function 010b: Close Session.....	307
6.3.3.5.4	Close Function 100b: Close Session with minimal radius.....	308
6.3.3.5.5	Close Function 101b: Finalize with Minimal Radius.....	308
6.3.3.5.6	Close Function 110b: Finalize.....	310
6.3.3.6	Close Function Definitions for DVD+RW.....	311
6.3.3.6.1	Reserved Close Functions.....	311
6.3.3.6.2	Close Function 000b: Quick Stop Background Format.....	311
6.3.3.6.3	Close Function 010b: Compatibility Stop Background Format with minimal radius.....	311
6.3.3.6.4	Close Function 011b: Compatibility Stop Background Format.....	311
6.3.3.7	Close Function Definitions for DVD+RW DL.....	312
6.3.3.7.1	Reserved Close Functions.....	312
6.3.3.7.2	Close Function 000b: Quick Background Format.....	312
6.3.3.7.3	Close Function 010b: Compatibility Stop Background Format with minimal radius.....	312
6.3.3.7.4	Close Function 011b: Compatibility Stop Background Format.....	312
6.3.3.8	Close Function Definitions for HD DVD-R.....	313
6.3.3.8.1	Reserved Close Functions.....	313
6.3.3.8.2	Close Function 001b: Close Logical Track.....	313
6.3.3.8.3	Close Function 010b: Close Session.....	313
6.3.3.8.4	Close Function 110b: Finalize the disc.....	313
6.3.3.9	Close Function Definitions for BD-R.....	314
6.3.3.9.1	Reserved Close Functions.....	314
6.3.3.9.2	Close Function 001b: Close Logical Track.....	314
6.3.3.9.3	Close Function 010b: Close Session.....	314
6.3.3.9.4	Close Function 110b: Finalize Disc.....	314
6.3.3.10	Close Function Definitions for the MRW Format.....	315
6.3.3.10.1	Reserved Close Functions.....	315
6.3.3.10.2	Close Function 010b: Stop Background Format.....	315
6.3.3.11	General Execution Characteristics.....	316
6.3.4	Timeouts.....	316
6.3.5	Error Reporting.....	316
6.4	ERASE (10) Command.....	317
6.4.1	Introduction.....	317
6.4.2	The CDB and its Parameters.....	317
6.4.2.1	The CDB.....	317
6.4.2.2	ERA.....	317
6.4.2.3	IMMED.....	317
6.4.2.4	Logical Block Address.....	317
6.4.2.5	Number of Blocks.....	317

6.4.3	Command Processing.....	318
6.4.4	Timeouts	318
6.4.5	Error Reporting	318
6.5	FORMAT UNIT Command.....	319
6.5.1	Introduction	319
6.5.2	The CDB and Its Parameters.....	319
6.5.2.1	The CDB.....	319
6.5.2.2	FmtData.....	319
6.5.2.3	CmpList	319
6.5.2.4	Format Code	320
6.5.2.5	Interleave Value	320
6.5.3	Format Parameter List	320
6.5.3.1	List Format	320
6.5.3.2	Format List Header.....	321
6.5.3.3	Format Descriptor.....	322
6.5.4	Command Processing.....	323
6.5.4.1	Overview	323
6.5.4.2	Formatting According to Format Type.....	323
6.5.4.2.1	Format Type = 00h (Full Format).....	323
6.5.4.2.1.1	CD-RW.....	323
6.5.4.2.1.2	DVD-RAM.....	323
6.5.4.2.1.3	DVD-RW.....	323
6.5.4.2.1.4	DVD+RW (both SL and DL)	323
6.5.4.2.1.5	HD DVD-RAM.....	323
6.5.4.2.1.6	BD-RE	323
6.5.4.2.1.7	BD-R.....	324
6.5.4.2.2	Format Type = 01h (Spare Area Expansion).....	325
6.5.4.2.2.1	DVD-RAM and HD DVD-RAM.....	325
6.5.4.2.2.2	BD-RE	325
6.5.4.2.3	Format Type = 04h (Zone Reformat).....	325
6.5.4.2.4	Format Type = 05h (Zone Format)	325
6.5.4.2.5	Format Type = 10h (CD/DVD-RW Full Format).....	326
6.5.4.2.6	Format Type = 11h (CD/DVD-RW Grow Session).....	326
6.5.4.2.7	Format Type = 12h (CD/DVD-RW Add Session).....	326
6.5.4.2.8	Format Type = 13h (DVD-RW Quick Grow the last Session).....	326
6.5.4.2.9	Format Type = 14h (DVD-RW Quick Add Session).....	327
6.5.4.2.10	Format Type = 15h (DVD-RW Quick).....	327
6.5.4.2.11	Format Type = 16h (HD DVD-R Expand Test Zone).....	327
6.5.4.2.12	Format Type = 20h (Full Format with sparing parameters)	327
6.5.4.2.13	Format Type = 24h, (MRW Full Format).....	328
6.5.4.2.14	Format Type = 26h, (DVD+RW Basic Format).....	329
6.5.4.2.15	Format Type = 30h (Format BD-RE with Spare Areas).....	329
6.5.4.2.15.1	Spare Allocation on 80mm Single Layer BD-RE	330
6.5.4.2.15.2	Spare Allocation on 80mm Dual Layer BD-RE.....	330
6.5.4.2.15.3	Spare Allocation on 120mm Single Layer BD-RE.....	330
6.5.4.2.15.4	Spare Allocation on 120mm Dual Layer BD-RE.....	331
6.5.4.2.16	Format Type = 31h (Format BD-RE without Spare Areas).....	331
6.5.4.2.17	Format Type = 32h (Format BD-R with Spare Areas)	332
6.5.4.2.18	Overview	332
6.5.4.2.19	Calculating Spare Size.....	332
6.5.4.2.20	Calculating Additional TDMA Space.....	333
6.5.4.3	Use of the IMMED Bit.....	334
6.5.4.4	Background Formatting.....	335
6.5.4.4.1	Overview	335
6.5.4.4.2	The Foreground Part of the Format Process	335
6.5.4.4.3	The Background Format Process	335

6.5.4.4.4	Stopping and Restarting Background Format.....	335
6.5.4.4.5	Writing During the Background Format Process	337
6.5.4.4.6	Recovering an Incomplete Format.....	337
6.5.5	Timeouts	337
6.5.6	Error Reporting	337
6.6	GET CONFIGURATION Command	338
6.6.1	The CDB and its Parameters	338
6.6.1.1	The CDB.....	338
6.6.1.2	RT.....	338
6.6.1.3	Starting Feature Number.....	339
6.6.1.4	Allocation Length.....	339
6.6.2	Command Processing.....	339
6.6.2.1	GET CONFIGURATION Response Data	339
6.6.2.2	Features	340
6.6.2.3	Profile List.....	340
6.6.3	Timeouts	340
6.6.4	Error Reporting	340
6.7	GET EVENT STATUS NOTIFICATION Command.....	341
6.7.1	The CDB and its Parameters	341
6.7.1.1	The CDB.....	341
6.7.1.2	Polled	341
6.7.1.3	Notification Class Request	341
6.7.1.4	Allocation Length.....	342
6.7.2	Command Processing.....	342
6.7.2.1	General.....	342
6.7.2.2	Event Status Notification Data	342
6.7.2.3	Operational Change Events	344
6.7.2.4	Power Management Events	345
6.7.2.5	External Request Events.....	346
6.7.2.6	Media Events.....	348
6.7.2.6.1	Event Code	348
6.7.2.6.2	Media Status	348
6.7.2.6.3	Start Slot	349
6.7.2.6.4	End Slot.....	349
6.7.2.7	Multiple Host Events.....	350
6.7.2.8	Device Busy Events	352
6.7.3	Timeouts	354
6.7.4	Error Reporting	354
6.8	GET PERFORMANCE Command.....	355
6.8.1	Introduction	355
6.8.2	The CDB and its Parameters	355
6.8.2.1	The CDB.....	355
6.8.2.2	Data Type.....	355
6.8.2.3	Starting LBA	355
6.8.2.4	Maximum Number of Descriptors.....	355
6.8.2.5	Type	355
6.8.3	Command Processing.....	356
6.8.3.1	Overview	356
6.8.3.2	Performance (Type field = 00h).....	356
6.8.3.3	Unusable Area Data (Type=01h)	358
6.8.3.4	Defect Status data (Type=02h).....	359
6.8.3.5	Write Speed (Type=03h).....	360
6.8.3.6	DBI (Type=04h).....	363
6.8.3.7	DBI cache zone (Type=05h)	364
6.8.4	Timeouts	365

6.8.5	Error Reporting	365
6.9	INQUIRY Command	366
6.9.1	Introduction	366
6.9.2	INQUIRY Data for ATAPI and USB Drives	366
6.9.3	Timeouts	366
6.9.4	Error Reporting	366
6.10	LOAD/UNLOAD MEDIUM Command	367
6.10.1	Introduction	367
6.10.2	The CDB and its Parameters	367
6.10.2.1	The CDB	367
6.10.2.2	IMMED	367
6.10.2.3	Start and LoUnlo	367
6.10.2.4	Slot	368
6.10.3	Command Processing	368
6.10.4	Timeouts	368
6.10.5	Error Reporting	368
6.11	MECHANISM STATUS Command	369
6.11.1	Introduction	369
6.11.2	The CDB and its Parameters	369
6.11.3	Command Processing	369
6.11.4	Timeouts	371
6.11.5	Error Reporting	371
6.12	MODE SELECT (10) Command	372
6.12.1	Introduction	372
6.12.2	Timeouts	372
6.12.3	Error Reporting	372
6.13	MODE SENSE (10) Command	373
6.13.1	Introduction	373
6.13.2	Timeouts	373
6.13.3	Error Reporting	373
6.14	PREVENT ALLOW MEDIUM REMOVAL Command	374
6.14.1	Introduction	374
6.14.2	The CDB and its Parameters	374
6.14.3	Command Processing	374
6.14.3.1	Overview	374
6.14.3.2	Persistent Prevent State	375
6.14.3.3	Prevent State	375
6.14.4	Timeouts	376
6.14.5	Error Reporting	376
6.15	READ (10) Command	377
6.15.1	Introduction	377
6.15.2	The CDB and Its Parameters	377
6.15.2.1	The CDB	377
6.15.2.2	DPO	377
6.15.2.3	FUA	377
6.15.2.4	Logical Block Address	378
6.15.2.5	Transfer Length	378
6.15.3	Command Processing	378
6.15.4	Timeouts	378
6.15.5	Error Reporting	379
6.16	READ (12) Command	380
6.16.1	Introduction	380
6.16.2	The CDB and Its Parameters	380
6.16.2.1	The CDB	380

6.16.2.2	DPO	380
6.16.2.3	FUA	380
6.16.2.4	Logical Block Address.....	381
6.16.2.5	Transfer Length.....	381
6.16.2.6	Streaming.....	381
6.16.3	Command Processing.....	381
6.16.4	Timeouts	381
6.16.5	Error Reporting	382
6.17	READ BUFFER Command.....	383
6.17.1	Introduction	383
6.17.2	Timeouts	383
6.17.3	Error Reporting	383
6.18	READ BUFFER CAPACITY Command.....	384
6.18.1	Introduction	384
6.18.2	The CDB and Its Parameters.....	384
6.18.2.1	The CDB	384
6.18.2.2	BLOCK	384
6.18.2.3	Allocation Length.....	384
6.18.3	Command Processing.....	384
6.18.3.1	Reporting Available Buffer in Bytes	384
6.18.3.2	Reporting Available Buffer in Blocks.....	385
6.18.4	Timeouts	386
6.18.5	Error Reporting	386
6.19	READ CAPACITY Command	387
6.19.1	Introduction	387
6.19.2	The CDB and Its Parameters.....	387
6.19.2.1	The CDB	387
6.19.2.2	Logical Block Address.....	387
6.19.2.3	PMI	387
6.19.3	Command Processing.....	387
6.19.4	Timeouts	389
6.19.5	Error Reporting	389
6.20	READ CD Command.....	390
6.20.1	Introduction	390
6.20.2	The CDB and Its Parameters.....	390
6.20.2.1	The CDB	390
6.20.2.2	Expected Sector Type.....	390
6.20.2.3	DAP	391
6.20.2.4	Starting Logical Block Address	391
6.20.2.5	Transfer Length.....	391
6.20.2.6	Main Channel Selection Bits	392
6.20.2.7	C2 Error Information.....	394
6.20.2.8	Sub-channel Selection bits	394
6.20.3	Command Processing.....	395
6.20.3.1	Main Channel Field Formats.....	395
6.20.3.1.1	Sync Field	395
6.20.3.1.2	Headers.....	395
6.20.3.1.3	User Data	395
6.20.3.1.4	EDC and ECC.....	395
6.20.3.1.5	C2 Errors.....	395
6.20.3.2	Sub-Channel Field Formats	395
6.20.3.2.1	Overview	395
6.20.3.2.2	RAW P-W Sub-channel	396
6.20.3.2.3	P and Q Sub-Channel.....	396
6.20.3.2.4	Corrected and De-interleaved R-W Sub-channel	396

6.20.3.2.5	CD-Text.....	396
6.20.4	Timeouts	397
6.20.5	Error Reporting	397
6.21	READ CD MSF Command	398
6.21.1	Introduction	398
6.21.2	The CDB and Its Parameters.....	398
6.21.2.1	The CDB	398
6.21.2.2	Expected Sector Type.....	398
6.21.2.3	DAP	398
6.21.2.4	Starting M, Starting S, and Starting F Fields	398
6.21.2.5	Ending M, Ending S, and Ending F Fields	399
6.21.2.6	Main Channel Selection bits	399
6.21.2.7	C2 Error Information.....	399
6.21.2.8	Sub-channel Selection bits	399
6.21.3	Command Processing.....	399
6.21.4	Timeouts	399
6.21.5	Error Reporting	399
6.22	READ DISC INFORMATION Command	400
6.22.1	Introduction	400
6.22.2	The CDB and Its Parameters.....	400
6.22.2.1	Data Type.....	401
6.22.2.2	Allocation Length.....	401
6.22.3	Command Processing.....	402
6.22.3.1	Data Type 000b: Standard Disc Information.....	402
6.22.3.2	Disc Information Length	403
6.22.3.3	Erasable Bit.....	403
6.22.3.4	State of Last Session	403
6.22.3.5	Disc Status	403
6.22.3.6	Number of First Track on Disc	403
6.22.3.7	First Track Number in Last Session.....	404
6.22.3.8	Last Track Number in Last Session.....	404
6.22.3.9	DID_V Bit	404
6.22.3.10	DBC_V Bit.....	404
6.22.3.11	URU Bit	404
6.22.3.12	DAC_V	404
6.22.3.13	Dbit.....	404
6.22.3.14	BG Format Status	404
6.22.3.15	Disc Type	405
6.22.3.16	Disc Identification Number	405
6.22.3.17	Last Session Lead-in Start Address.....	405
6.22.3.18	Last Possible Lead-out Start Address.....	405
6.22.3.19	Disc Bar Code	406
6.22.3.20	Disc Application Code	406
6.22.3.21	OPC Table	406
6.22.3.22	Data Type 001b: Track Resources Information	407
6.22.3.23	Data Type 010b: POW Resources Information	408
6.22.4	Timeouts	409
6.22.5	Error Reporting	409
6.23	READ DISC STRUCTURE Command	410
6.23.1	Introduction	410
6.23.2	The CDB and Its Parameters.....	410
6.23.2.1	The CDB	410
6.23.2.2	Media Type	410
6.23.2.3	Address	411
6.23.2.4	Layer Number	411

6.23.2.5	Format.....	411
6.23.2.6	Allocation Length.....	411
6.23.2.7	AGID	411
6.23.3	Command Processing.....	411
6.23.3.1	Generic Disc Structures	411
6.23.3.1.1	Format Code C0h: Write Protection Status	412
6.23.3.1.2	Format Code FFh: Disc Structure List	413
6.23.3.2	Disc Structures for Media Type = 0000b (DVD and HD DVD)	414
6.23.3.2.1	Format Code 00h: Physical Format Information	416
6.23.3.2.2	Format Code 01h: DVD Copyright Information.....	420
6.23.3.2.3	Format Code 02h: Disc Key.....	421
6.23.3.2.4	Format Code 03h: BCA Information.....	422
6.23.3.2.5	Format Code 04h: DVD Disc Manufacturing Information	423
6.23.3.2.6	Format Code 05h: Copyright Management Information	424
6.23.3.2.7	Format Code 06h: Media Identifier	426
6.23.3.2.8	Format Code 07h: Media Key Block.....	427
6.23.3.2.9	Format Code 08h: DVD-RAM Disc Definition Structure (DDS)	428
6.23.3.2.10	Format Code 09h: DVD-RAM Medium Status.....	429
6.23.3.2.11	Format Code 0Ah: DVD-RAM Spare Area Information.....	431
6.23.3.2.12	Format Code 0Bh: DVD-RAM Recording Type Information.....	432
6.23.3.2.13	Format Code 0Ch: RMD in the last Border-out	433
6.23.3.2.14	Format Code 0Dh: Recording Management Area Data	434
6.23.3.2.15	Format Code 0Eh: Pre-recorded Information in Lead-in	435
6.23.3.2.16	Format Code 0Fh: Unique Disc Identifier	437
6.23.3.2.17	Format Code 10h: Format Information of Control Data Zone in the Lead-in	438
6.23.3.2.18	Format Code 11h: ADIP Information	439
6.23.3.2.19	Format Code 12h: Copyright Protection Information from HD DVD Lead-in	440
6.23.3.2.20	Format Code 15h: Copyright Data Section from HD DVD/DVD-ROM3 - AACS adjusted 441	
6.23.3.2.21	Format Code 19h: HD DVD-R Medium Status.....	442
6.23.3.2.22	Format Code 1Ah: HD DVD-R - Last recorded RMD in the latest RMZ.....	443
6.23.3.2.23	Format Code 20h: DVD+/-R DL - Layer Capacity	444
6.23.3.2.24	Format Code 21h: DVD-R DL - Middle Zone start address	445
6.23.3.2.25	Format Code 22h: DVD-R DL - Jump Interval Size.....	446
6.23.3.2.26	Format Code 23h: DVD-R DL - Manual Layer Jump Address	447
6.23.3.2.27	Format Code 24h: DVD-R DL - Remapping information of the specified Anchor Point 448	
6.23.3.2.28	Format Code 30h: Disc Control Blocks	449
6.23.3.2.28.1	Overview	449
6.23.3.2.28.2	Formatting DCB (FDCB).....	450
6.23.3.2.28.3	Write Inhibit DCB (WDCB).....	450
6.23.3.2.28.4	Session DCB.....	452
6.23.3.2.28.5	DCB List.....	453
6.23.3.2.29	Format Code 31h: Read MTA ECC Block	453
6.23.3.2.30	Format Code 80h: AACS volume identifier	455
6.23.3.2.31	Format Code 81h: Pre-Recorded AACS media serial number	456
6.23.3.2.32	Format Code 82h: AACS media identifier	457
6.23.3.2.33	Format Code 83h: AACS media key block.....	458
6.23.3.2.34	Format Code 90h: List of recognized format layers	459
6.23.3.3	BD Disc Structures.....	460
6.23.3.3.1	Format Code 00h: Disc Information (DI).....	461
6.23.3.3.2	Format Code 08h: Disc Definition Structure (DDS)	463
6.23.3.3.3	Format Code 09h: Cartridge Status	464
6.23.3.3.4	Format Code 0Ah: Spare Area Information	465
6.23.3.3.5	Format Code 12h: Raw Defect List (DFL)	466
6.23.3.3.6	Format Code 30h: Physical Access Control (PAC)	468

6.23.3.3.6.1	General	468
6.23.3.3.6.2	Primary PAC	471
6.23.3.3.6.3	Disc Write Protect PAC	472
6.23.4	Timeouts	473
6.23.5	Error Reporting	473
6.24	READ FORMAT CAPACITIES Command	474
6.24.1	Introduction	474
6.24.2	The CDB and Its Parameters	474
6.24.2.1	The CDB	474
6.24.2.2	Allocation Length	474
6.24.3	Command Processing	475
6.24.3.1	Capacity List Header	475
6.24.3.2	Current/Maximum Capacity Descriptor	476
6.24.3.3	Formattable Capacity Descriptors	477
6.24.4	Timeouts	480
6.24.5	Error Reporting	480
6.25	READ TOC/PMA/ATIP Command	481
6.25.1	Introduction	481
6.25.2	The CDB and Its Parameters	481
6.25.2.1	The CDB	481
6.25.2.2	MSF	481
6.25.2.3	Format	481
6.25.2.4	Track/Session Number	481
6.25.2.5	Allocation Length	482
6.25.3	Command Processing	483
6.25.3.1	Overview	483
6.25.3.2	Response Format 0000b: Formatted TOC	484
6.25.3.2.1	General	484
6.25.3.2.2	General Case for CD	484
6.25.3.2.3	MRW Deviations	485
6.25.3.2.4	DVD-ROM, HD DVD-ROM, DVD-RAM, HD DVD-RAM, DVD+RW, Single Session DVD-R/-RW, Single Session DVD+R, and Single Session HD DVD-R	486
6.25.3.2.5	DVD-R/-RW with Multiple Sessions	486
6.25.3.2.6	DVD+R with Multiple Sessions	486
6.25.3.2.7	BD-ROM	487
6.25.3.2.8	Blank BD-RE	487
6.25.3.2.9	Formatted BD-RE	487
6.25.3.2.10	Blank BD-R	487
6.25.3.2.11	BD-R RRM	487
6.25.3.2.12	BD-R SRM-POW and SRM+POW	488
6.25.3.3	Response Format 0001b: Multi-session Information	490
6.25.3.3.1	General	490
6.25.3.3.2	MRW Deviations	490
6.25.3.3.3	Non-CD Cases	491
6.25.3.4	Response Format 0010b: Raw TOC	492
6.25.3.4.1	General	492
6.25.3.4.2	CD-MRW Deviations	494
6.25.3.4.3	Non-CD Discs	494
6.25.3.5	Response Format 0011b: PMA	495
6.25.3.5.1	General	495
6.25.3.5.2	CD-MRW Deviations	495
6.25.3.5.3	Non-CD Discs	495
6.25.3.6	Response Format 0100b: ATIP	496
6.25.3.6.1	General	496
6.25.3.6.2	ATIP Descriptor for CD-R/RW Media	497

6.25.3.6.2.1	General	497
6.25.3.6.2.2	Special Information 1	497
6.25.3.6.2.3	Special Information 2: Start Time of Lead-in	497
6.25.3.6.2.4	Special Information 3: Last Possible Start Time of Lead-out	497
6.25.3.6.2.5	Special Information 3: Start Time of Additional Capacity	497
6.25.3.6.2.6	Additional Information 1	498
6.25.3.6.3	Non-CD Discs	498
6.25.3.7	Response Format 0101b: CD-TEXT	499
6.25.3.7.1	CD Discs	499
6.25.3.7.2	Non-CD Discs	499
6.25.4	Timeouts	499
6.25.5	Error Reporting	499
6.26	READ TRACK INFORMATION Command	500
6.26.1	Introduction	500
6.26.2	The CDB and Its Parameters	500
6.26.2.1	The CDB	500
6.26.2.2	Open	500
6.26.2.3	Address/Number Type	501
6.26.2.4	Logical BlockAddress/Track/Session Number Fields	501
6.26.2.5	Determining the Specific Logical Track	501
6.26.2.6	Allocation Length	502
6.26.3	Command Processing	502
6.26.3.1	Overview	502
6.26.3.2	Data Length	504
6.26.3.3	Logical Track Number	504
6.26.3.4	Session Number	504
6.26.3.5	Copy bit	504
6.26.3.6	LJRS	504
6.26.3.7	Damage Bit	504
6.26.3.8	Track Mode	505
6.26.3.9	Track Status: RT, Blank, Packet, and FP Bits	505
6.26.3.10	Data Mode	509
6.26.3.11	NWA_V	509
6.26.3.12	LRA_V	509
6.26.3.13	Track Start Address	509
6.26.3.14	Next Writable Address	509
6.26.3.15	Free Blocks	510
6.26.3.15.1	CD	510
6.26.3.15.2	Formatted Rewritable Media: DVD-RAM, DVD+RW, HD DVD-RAM, BD-RE	511
6.26.3.15.3	DVD-R/-RW, DVD-R DL	511
6.26.3.15.4	DVD+R, DVD+R DL, HD DVD-R, BD-R	511
6.26.3.16	Fixed Packet Size	511
6.26.3.17	Track Size	511
6.26.3.17.1	General	511
6.26.3.17.2	CD Track Size	511
6.26.3.17.3	DVD-ROM Track Size	511
6.26.3.17.4	DVD-RAM Track Size	511
6.26.3.17.5	DVD-R, DVD-R DL when LJRS = 00b, and DVD-RW Track Size	512
6.26.3.17.6	DVD-R DL when LJRS ≠ 00b Track Size	512
6.26.3.17.7	DVD+RW and DVD+RW DL Track Size	512
6.26.3.17.8	DVD+R and DVD+R DL Track Size	512
6.26.3.17.9	HD DVD-R Track Size	513
6.26.3.18	Last Recorded Address	513
6.26.3.19	Read Compatibility LBA	513
6.26.3.20	Next Layer Jump Address	513
6.26.3.21	Last Layer Jump Address	513

6.26.4	Timeouts	514
6.26.5	Error Reporting	514
6.27	REPAIR TRACK Command	515
6.27.1	Introduction	515
6.27.2	The CDB and Its Parameters.....	515
6.27.2.1	The CDB	515
6.27.2.2	IMMED	515
6.27.2.3	Track Number	515
6.27.3	Command Processing.....	515
6.27.4	Timeouts	515
6.27.5	Error Reporting	516
6.28	REPORT KEY Command.....	517
6.28.1	Introduction	517
6.28.2	The CDB and Its Parameters.....	517
6.28.2.1	The CDB	517
6.28.2.2	Reserved/Logical Block Address/Starting Offset.....	517
6.28.2.3	Reserved/Block Count/VCPS Function.....	518
6.28.2.4	Key Class	518
6.28.2.5	Allocation Length.....	518
6.28.2.6	AGID	518
6.28.2.7	Key Format.....	518
6.28.3	Command Processing.....	519
6.28.3.1	Key Class 00h, DVD CSS/CPPM or CPRM	519
6.28.3.1.1	General	519
6.28.3.1.2	Key Format = 000000b, AGID for CSS/CPPM	520
6.28.3.1.3	Key Format = 000001b, Challenge Key.....	520
6.28.3.1.4	Key Format = 000010b, KEY1	521
6.28.3.1.5	Key Format = 000100b, TITLE KEY	522
6.28.3.1.6	Key Format = 000101b, Authentication Success Flag.....	522
6.28.3.1.7	Key Format = 001000b, RPC State	524
6.28.3.1.8	Key Format = 010001b, AGID for CPRM.....	524
6.28.3.1.9	Key Format = 111111b, Invalidate AGID	525
6.28.3.1.10	Invalidate Authentication Grant ID for AACS (Key Format = 111111b)	525
6.28.3.2	Key Class 02h, AACS	526
6.28.3.2.1	General	526
6.28.3.2.2	Authentication Grant ID for AACS (Key Format = 000000b)	527
6.28.3.2.3	Drive Certificate Challenge (Key Format = 000001b).....	528
6.28.3.2.4	Drive Key (Key Format = 000010b).....	529
6.28.3.2.5	Binding Nonce generated by the Drive (Key Format = 100000b).....	530
6.28.3.2.6	Binding Nonce (read from the medium) (Key Format = 100001b)	531
6.28.3.2.7	Invalidate Authentication Grant ID for AACS (Key Format = 111111b).....	531
6.28.3.3	Key Class 20h, VCPS	532
6.28.3.3.1	General	532
6.28.3.3.2	VCPS Function Code = 01h, DKB	533
6.28.3.3.3	VCPS Function Code = 02h, Device ID	534
6.28.3.3.4	VCPS Function Code = 03h, Key Contribution.....	535
6.28.3.3.5	VCPS Function Code = 04h, DKB Hash and Unique ID.....	536
6.28.3.4	VCPS Function Code = 05h, DKB Information	537
6.28.4	Timeouts	538
6.28.5	Error Reporting	538
6.29	REQUEST SENSE Command	539
6.29.1	Introduction	539
6.29.2	Timeouts	539
6.29.3	Error Reporting	539
6.30	RESERVE TRACK Command.....	540

6.30.1	Introduction	540
6.30.2	The CDB and Its Parameters.....	540
6.30.2.1	The CDB	540
6.30.2.2	RMZ	540
6.30.2.3	ARSV	541
6.30.2.4	Logical Track Reservation Parameter.....	541
6.30.3	Command Processing.....	542
6.30.3.1	General	542
6.30.3.2	RMZ Reservation	542
6.30.3.3	Track Reservation by Reservation Size.....	542
6.30.3.3.1	Track Reservation by Reservation Size on CD-R/RW.....	542
6.30.3.3.2	Track (RZone) Reservation by Reservation Size on DVD-R/-RW and DVD-R DL	543
6.30.3.3.3	Track Reservation on by Reservation Size on DVD+R and DVD+R DL	543
6.30.3.3.4	Track Reservation by Reservation Size on HD DVD-R.....	543
6.30.3.3.5	Track Reservation on by Reservation Size on BD-R.....	544
6.30.3.4	Track Reservation by Reservation LBA.....	544
6.30.3.4.1	General	544
6.30.3.4.2	Track Reservation by Reservation LBA on CD-R/RW.....	544
6.30.3.4.3	Track Reservation by Reservation LBA on DVD-R/-RW, DVD-R DL, and HD DVD-R	544
6.30.3.4.4	Track Reservation by Reservation LBA on DVD+R and DVD+R DL	544
6.30.3.4.5	Track Reservation by Reservation LBA on BD-R.....	544
6.30.4	Timeouts	544
6.30.5	Error Reporting	545
6.31	SEEK (10) Command	546
6.31.1	Introduction	546
6.31.2	The CDB and Its Parameters.....	546
6.31.2.1	The CDB	546
6.31.2.2	Logical Block Address.....	546
6.31.3	Command Processing.....	546
6.31.4	Timeouts	546
6.31.5	Error Reporting	547
6.32	SEND CUE SHEET Command	548
6.32.1	Introduction	548
6.32.2	The CDB and Its Parameters.....	548
6.32.2.1	The CDB	548
6.32.2.2	Cue Sheet Size	548
6.32.3	Command Processing.....	548
6.32.3.1	General	548
6.32.3.2	Information of the Absolute Disc Location	549
6.32.3.3	Control/Address Field	550
6.32.3.4	CTL Field (upper 4 bits)	550
6.32.3.5	ADR Field (lower 4 bits)	551
6.32.3.6	TNO.....	551
6.32.3.7	INDEX Field	551
6.32.3.8	Data Form	551
6.32.3.9	SCMS (Serial Copy Management System).....	551
6.32.3.10	Data Form of Main Data.....	551
6.32.3.11	CD-DA Data Form.....	552
6.32.3.12	CD-ROM mode 1 Form	552
6.32.3.13	CD-ROM XA, CD-I Form.....	553
6.32.3.14	CD-ROM mode 2	553
6.32.3.15	Data Form of Sub-channel.....	554
6.32.3.16	Absolute Time	555
6.32.3.17	Session Format.....	555

6.32.3.18 Pre-gap	555
6.32.3.19 Post-gap.....	555
6.32.3.20 Media Catalog Number	555
6.32.3.21 ISRC.....	556
6.32.4 Timeouts	556
6.32.5 Error Reporting	556
6.33 SEND DISC STRUCTURE Command	557
6.33.1 Introduction	557
6.33.2 The CDB and Its Parameters.....	557
6.33.2.1 The CDB	557
6.33.2.2 Media Type	557
6.33.2.3 Format.....	558
6.33.2.4 Parameter List Length.....	558
6.33.3 Command Processing.....	559
6.33.3.1 General	559
6.33.3.2 SEND DISC INFORMATION for DVD and HD DVD (Media Type = 0h).....	559
6.33.3.2.1 Format = 04h: User Specific Data.....	559
6.33.3.2.2 Format = 05h: Copyright Management Information.....	560
6.33.3.2.3 Format = 0Fh: Timestamp.....	562
6.33.3.2.4 Format = 20h: Layer Boundary Information.....	562
6.33.3.2.5 Format = 21h: Shifted Middle Area Start Address	564
6.33.3.2.6 Format = 22h: Jump Interval Size.....	565
6.33.3.2.7 Format = 23h: Manual Layer Jump Address.....	566
6.33.3.2.8 Format = 24h: Remapping Address.....	567
6.33.3.2.9 Format Code = 30h: Disc Control Block	568
6.33.3.2.9.1 General.....	568
6.33.3.2.9.2 Erasing a DCB.....	568
6.33.3.2.9.3 Write Inhibit DCB.....	568
6.33.3.2.10 Format Code = C0h: Write Protection	570
6.33.3.3 SEND DISC INFORMATION for BD (Media Type = 1h)	571
6.33.3.3.1 Format = 0Fh: Timestamp.....	571
6.33.3.3.2 Format Code = 30h: Send a PAC	571
6.33.3.3.3 General	571
6.33.3.3.4 DWP PAC	572
6.33.4 Timeouts	573
6.33.5 Error Reporting	573
6.34 SEND KEY Command.....	574
6.34.1 Introduction	574
6.34.2 The CDB and Its Parameters.....	574
6.34.2.1 The CDB	574
6.34.2.2 Reserved/VCPS Function	574
6.34.2.3 Key Class.....	575
6.34.2.4 Parameter List Length.....	575
6.34.2.5 AGID	575
6.34.2.6 Key Format.....	575
6.34.3 Command Processing.....	575
6.34.3.1 Key Class 00h, DVD CSS/CPPM or CPRM	575
6.34.3.1.1 General	575
6.34.3.1.2 Key Format = 000001b, Challenge.....	575
6.34.3.1.3 Key Format = 000011b, Response.....	577
6.34.3.1.4 Key Format = 000110b, RPC Structure.....	578
6.34.3.1.5 Invalidate Authentication Grant ID (Key Format = 111111b).....	578
6.34.3.2 AACs.....	579
6.34.3.2.1 Host Certificate Challenge (KEY Format = 000001b).....	579
6.34.3.2.2 Host Key (KEY Format = 000010b).....	580

6.34.3.2.3	Invalidate Authentication Grant ID for AACS (Key Format = 111111b).....	580
6.34.3.3	VCPS	581
6.34.3.3.1	General	581
6.34.3.3.2	VCPS Function Code = 01h, Authorization Key	582
6.34.3.3.3	VCPS Function Code = 02h, Key Contribution	583
6.34.4	Timeouts	584
6.34.5	Error Reporting	584
6.35	SEND OPC INFORMATION Command	585
6.35.1	Introduction	585
6.35.2	The CDB and Its Parameters	585
6.35.2.1	The CDB	585
6.35.2.2	DoOpc	585
6.35.2.3	Exclude0 and Exclude1	586
6.35.2.4	Parameter List Length	586
6.35.2.5	Parameter List Format	586
6.35.3	Command Processing	587
6.35.4	Timeouts	587
6.35.5	Error Reporting	587
6.36	SET CD SPEED Command	588
6.36.1	Introduction	588
6.36.2	The CDB and Its Parameters	588
6.36.2.1	The CDB	588
6.36.2.2	Rotational Control	588
6.36.2.3	Drive Read Speed	589
6.36.2.4	Drive Write Speed	589
6.36.3	Command Processing	589
6.36.4	Timeouts	589
6.36.5	Error Reporting	589
6.37	SET READ AHEAD Command	590
6.37.1	Introduction	590
6.37.2	The CDB and Its Parameters	590
6.37.2.1	The CDB	590
6.37.2.2	Trigger Logical Block Address	590
6.37.2.3	Read-Ahead Logical Block Address	590
6.37.3	Command Processing	590
6.37.4	Timeouts	591
6.37.5	Error Reporting	591
6.38	SET STREAMING Command	592
6.38.1	Introduction	592
6.38.2	The CDB and Its Parameters	592
6.38.2.1	The CDB	592
6.38.2.2	Type	592
6.38.2.3	Parameter List Length	593
6.38.3	Command Processing	593
6.38.3.1	General	593
6.38.3.2	Performance Descriptor (Type=0)	593
6.38.3.3	DBI cache zone Descriptor (Type=5)	594
6.38.4	Timeouts	595
6.38.5	Error Reporting	595
6.39	START STOP UNIT Command	596
6.39.1	Introduction	596
6.39.2	The CDB and Its Parameters	596
6.39.2.1	The CDB	596
6.39.2.2	IMMED	596
6.39.2.3	Format-Layer Number	596

6.39.2.4	Power Conditions	597
6.39.2.5	FL (Format-layer)	597
6.39.2.6	LoEj and Start	597
6.39.3	Command Processing	598
6.39.3.1	Load/Eject Operations and Actions	598
6.39.3.2	Power Condition Changes	598
6.39.4	Timeouts	599
6.39.5	Error Reporting	599
6.40	SYNCHRONIZE CACHE Command	600
6.40.1	Introduction	600
6.40.2	The CDB and Its Parameters	600
6.40.2.1	The CDB	600
6.40.2.2	IMMED	601
6.40.2.3	Logical Block Address	601
6.40.2.4	Number of Blocks	601
6.40.3	Command Processing	601
6.40.4	Timeouts	601
6.40.5	Error Reporting	601
6.41	TEST UNIT READY Command	602
6.41.1	Introduction	602
6.41.2	Timeouts	602
6.41.3	Error Reporting	602
6.42	VERIFY (10) Command	603
6.42.1	Introduction	603
6.42.2	The CDB and Its Parameters	603
6.42.2.1	The CDB	603
6.42.2.2	DPO	603
6.42.2.3	BytChk	603
6.42.2.4	Logical Block Address	603
6.42.2.5	Number of Blocks	603
6.42.2.6	G3tout	603
6.42.3	Command Processing	604
6.42.4	Timeouts	604
6.42.5	Error Reporting	604
6.43	WRITE (10) Command	605
6.43.1	Introduction	605
6.43.2	The CDB and Its Parameters	605
6.43.2.1	The CDB	605
6.43.2.2	FUA	605
6.43.2.3	TSR	606
6.43.2.4	Logical Block Address	606
6.43.2.5	Transfer Length	607
6.43.3	Command Processing	607
6.43.3.1	General	607
6.43.3.2	CD-R Fixed Packet, Variable Packet, Track-At-Once	607
6.43.3.3	SAO Raw on CD-R/-RW, DAO and Incremental on DVD-R/-RW	607
6.43.3.4	Write Protect	609
6.43.4	Timeouts	609
6.43.5	Error Reporting	609
6.44	WRITE (12) Command	610
6.44.1	Introduction	610
6.44.2	The CDB and Its Parameters	610
6.44.2.1	The CDB	610
6.44.2.2	FUA	610
6.44.2.3	TSR	610

6.44.2.4	Logical Block Address.....	610
6.44.2.5	Transfer Length.....	611
6.44.2.6	VNR.....	611
6.44.2.6.1	When the Currently Mounted Disc is not BD-R.....	611
6.44.2.6.2	When the Currently Mounted Disc is BD-R.....	611
6.44.3	Command Processing.....	611
6.44.3.1	General.....	611
6.44.3.2	Blocking Factor.....	611
6.44.3.3	Streaming.....	611
6.44.3.4	Unable to Write.....	612
6.44.3.5	DVD-RAM.....	612
6.44.3.6	DVD+RW.....	612
6.44.4	Timeouts.....	612
6.44.5	Error Reporting.....	612
6.45	WRITE AND VERIFY (10) Command.....	613
6.45.1	Introduction.....	613
6.45.2	The CDB and Its Parameters.....	613
6.45.2.1	The CDB.....	613
6.45.2.2	TSR.....	613
6.45.2.3	Starting Logical Block Address.....	613
6.45.2.4	Transfer Length.....	613
6.45.3	Command Processing.....	613
6.45.4	Timeouts.....	614
6.45.5	Error Reporting.....	614
6.46	WRITE BUFFER Command.....	615
6.46.1	Introduction.....	615
6.46.2	Timeouts.....	615
6.46.3	Error Reporting.....	615
7	Mode Parameters for Multi-Media Devices.....	617
7.1	Overview.....	617
7.2	Mode Parameter List.....	617
7.2.1	Mode Parameter Header Format.....	617
7.2.2	Mode Pages.....	618
7.2.3	Mode Page Format.....	618
7.2.3.1	Parameters Savable bit (PS).....	618
7.2.3.1.1	PS in the MODE SENSE Returned Data.....	618
7.2.3.1.2	PS in the MODE SELECT Parameter List.....	618
7.2.3.2	Page Code.....	618
7.2.3.2.1	Page Code in the MODE SENSE Returned Data.....	618
7.2.3.2.2	Page Code in the MODE SELECT Parameter List.....	618
7.2.3.3	Page Length.....	619
7.2.3.3.1	Page Length in the MODE SENSE Returned Data.....	619
7.2.3.3.2	Page Length in the MODE SELECT Parameter List.....	619
7.2.4	Using Mode Parameters for MM Devices.....	619
7.3	Read/Write Error Recovery Parameters Mode Page (Page Code 01h).....	620
7.3.1	Introduction.....	620
7.3.2	The Mode Page and its Parameters.....	620
7.3.2.1	The Mode Page.....	620
7.3.2.2	PS.....	620
7.3.2.3	Page Code.....	620
7.3.2.4	Page Length.....	620
7.3.2.5	Error Recovery Behavior.....	621
7.3.2.5.1	Automatic Write Reallocation Enabled (AWRE).....	621
7.3.2.5.2	Automatic Read Reallocation Enabled (ARRE).....	621

7.3.2.5.3	Transfer Block (TB)	621
7.3.2.5.4	Read Continuous (RC)	621
7.3.2.5.5	Post Error (PER)	622
7.3.2.5.6	Disable Transfer on Error (DTE)	622
7.3.2.5.7	Disable Correction (DCR)	622
7.3.2.5.8	Error Recovery Cases for CD	623
7.3.2.5.9	Error Recovery Cases for DVD	626
7.3.2.6	Read Retry Count	626
7.3.2.7	Enhanced Media Certification and Defect Reporting (EMCDR)	626
7.3.2.7.1	Description of PER bit and EMCDR field	626
7.3.2.7.2	In case of Enhanced Defect Reporting Feature is not supported or is not current	627
7.3.2.7.3	In case of Enhanced Defect Reporting Feature is current	627
7.3.2.8	Write Retry Count	627
7.3.2.9	Error Reporting Window size	628
7.4	MRW Mode Page (Page Code 03h)	629
7.4.1	Introduction	629
7.4.2	The Mode Page and its Parameters	629
7.4.2.1	The Mode Page	629
7.4.2.2	PS	629
7.4.2.3	Page Code	629
7.4.2.4	Page Length	629
7.4.2.5	LBA Space	629
7.5	Write Parameters Mode Page (Page Code 05h)	630
7.5.1	Introduction	630
7.5.2	Applicable Media	630
7.5.3	Exempted Media	630
7.5.4	The Mode Page and its Parameters	630
7.5.4.1	The Mode Page	630
7.5.4.2	PS	631
7.5.4.3	Page Code	631
7.5.4.4	Page Length	631
7.5.4.5	BUFE	631
7.5.4.6	LS_V	632
7.5.4.7	Link Size	632
7.5.4.8	Test Write	632
7.5.4.9	Write Type	633
7.5.4.10	FP	633
7.5.4.11	Copy	634
7.5.4.12	Track Mode	634
7.5.4.13	Data Block Type	634
7.5.4.14	Host Application Code	636
7.5.4.15	Session Format Code	636
7.5.4.16	Packet Size	636
7.5.4.17	Audio Pause Length	636
7.5.4.18	Media Catalog Number (MCN)	636
7.5.4.19	International Standard Recording Code (ISRC)	637
7.6	Caching Mode Page (08h)	638
7.6.1	Introduction	638
7.6.2	The Mode Page and its Parameters	638
7.6.2.1	The Mode Page	638
7.6.2.2	PS	638
7.6.2.3	Page Code	638
7.6.2.4	Page Length	638
7.6.2.5	WCE (Write Cache Enable)	638
7.6.2.6	RCD (Read Cache Disable)	638

- 7.7 Power Condition mode page (Page Code 1Ah) 639
- 7.8 Informational Exceptions Control Mode Page (Page Code 1Ch)..... 640
- 7.9 Timeout and Protect Page (Page Code 1Dh)..... 641
 - 7.9.1 Introduction 641
 - 7.9.2 The Mode Page and its Parameters 641
 - 7.9.2.1 The Mode Page 641
 - 7.9.2.2 PS 641
 - 7.9.2.3 Page Code 641
 - 7.9.2.4 Page Length 641
 - 7.9.2.5 G3Enable 641
 - 7.9.2.6 TMOE 641
 - 7.9.2.7 DISP 642
 - 7.9.2.8 SWPP 642
 - 7.9.2.9 Group 1 Minimum Timeout..... 642
 - 7.9.2.10 Group 2 Minimum Timeout 642
 - 7.9.2.11 Group 3 Time-out..... 642
- Annex A Implementation Notes: ATA Layer of ATAPI..... 643**
 - A.1 Introduction 643
 - A.2 Definitions 643
 - A.3 No Block Descriptors in MM ATAPI Devices 644
 - A.4 Use of Immediate..... 645
 - A.5 Mapping of Reset Functions..... 645
- Annex B Implementation Notes: SCSI Parallel Interface 647**
 - B.1 Introduction 647
 - B.2 SCSI Signal Utilization..... 647
 - B.3 Reset Functionality 647
 - B.3.1 Power On Reset..... 647
 - B.3.2 Hard Reset..... 647
 - B.3.3 TARGET RESET task management function 647
 - B.3.4 Device Reset..... 647
 - B.3.5 Power Management and Device Reset in SCSI 647
 - B.3.6 Mapping of reset functions..... 648
- Annex C Implementation Notes: SCSI Serial Bus Protocol..... 649**
 - C.1 SBP-2 Definitions..... 649
 - C.2 SBP-2 Storage Model..... 650
 - C.2.1 Overview 650
 - C.2.2 Model configuration..... 650
 - C.2.3 Model operation 650
 - C.2.4 Reconnect /Power reset support (normative) 651
 - C.3 Configuration ROM support (normative)..... 651
 - C.3.1 Overview 651
 - C.3.2 Unit Directory – Command_Set_Spec_ID 652
 - C.3.3 Unit Directory – Command_Set..... 652
 - C.3.4 Unit Directory – Command_Set_Revision 652
 - C.3.5 Unit Directory – Logical_Unit_Number 653
 - C.4 Login support (normative)..... 653
 - C.5 Security support (normative) 653
 - C.6 Status block support (normative)..... 654
 - C.7 Unsolicited Status support (normative)..... 654

C.8	Unit attention condition	654
Annex D	Implementation Notes: Universal Serial Bus	655
D.1	USB and Mass Storage Definitions	655
D.1.2	Capabilities	655
D.2	Bulk Only Mass Storage	657
D.2.1	Scope	657
D.2.2	Bulk-Only Mass Storage Reset (class-specific request).....	657
D.2.3	Get Max LUN (class-specific request)	658
D.2.4	Initiator/Device Packet Transfer Order	658
D.2.5	Command Queuing	658
D.2.6	Standard Descriptors	658
D.2.7	Device Descriptor.....	659
D.2.8	Serial Number	659
D.2.9	Valid Serial Number Characters	659
D.3	Descriptors.....	660
D.3.1	Configuration Descriptor	660
D.3.2	Interface Descriptor.....	660
D.3.3	Endpoint Descriptors.....	661
D.3.4	Bulk-In Endpoint.....	661
D.3.5	Bulk-Out Endpoint.....	662
D.4	Command/Data/Status Protocol.....	662
D.4.1	Command Block Wrapper (CBW).....	662
D.4.2	Command Status Wrapper (CSW)	663
Annex E	Legacy Specifications	665
E.1	Overview	665
E.2	CD Audio External Play	665
E.3	Double Density Compact Disc (DDCD).....	665
E.4	GET EVENT STATUS NOTIFICATION Command – Operational Change Events	665
E.5	GET EVENT STATUS NOTIFICATION Command – Device Busy Events.....	666
E.6	FORMAT UNIT Command, Format Code = 111b	666
E.7	SEND EVENT Command	666
E.8	Mode Parameters Block Descriptors	666
E.9	READ TOC/PMA/ATIP Command: CDB Format field definition	667
E.10	CD Device Parameters Mode Page (Page 0Dh).....	668
E.11	MM Capabilities and Mechanical Status Page (Page Code 2Ah).....	668
Annex F	Error Reporting	669
F.1	Overview	669
F.2	Deferred Errors	669
F.3	Error Lists	669
F.3.1	Unit Attention conditions	670
F.3.2	CDB or Parameter Validation Errors.....	671
F.3.3	Readiness Errors	672
F.3.4	Protocol Errors	673
F.3.5	General Media Access Errors.....	674
F.3.6	Errors Associated with Reading.....	675
F.3.7	Errors Associated with Writing.....	676
F.3.8	Hardware Failures.....	678
F.3.9	Errors Associated with non-ATAPI Environments	679
F.3.10	Drive Sense Key, ASC and ASCQ Assignments.....	680

Annex G Event Reporting Using GESN 687
G.1 Introduction687
G.2 Functional Behavior Guidelines.....687

Annex H Power Management 689
H.1 Power Management States689
H.2 Power State Transitions.....690
H.3 Power Management State Diagram690
H.4 Power Management Timers692
H.5 Standby Timer693
H.6 Power Management Status Reporting.....695

Tables

Table 1 — Logical Track Naming	31
Table 2 — Properties of Logical Tracks	32
Table 3 — Busy Condition Examples	35
Table 4 — SK/ASC/ASCQ Specification for Unable to Write Situations	36
Table 5 — Commands that should report the Not Ready Condition	38
Table 6 — Commands that should not report the Not Ready Condition	38
Table 7 — Commands with Group 1 Timeout	39
Table 8 — Group 2 Timeout Commands	40
Table 9 — No Timeout Commands	40
Table 10 — Group 3 Timeout Commands	41
Table 11 — Power Conditions	44
Table 12 — General CD Spiral Structure	45
Table 13 — Small Frame Content	45
Table 14 — CD Frame Structure from Small Frames	46
Table 15 — Sub-Channel byte layout	46
Table 16 — P-Sub-Channel Layout	47
Table 17 — Q Sub-channel record format	49
Table 18 — ISRC 6 bit character codes (in hexadecimal)	51
Table 19 — Sync Pattern Block Header	54
Table 20 — Mode Zero Data Format	55
Table 21 — Mode 1 Data Format	55
Table 22 — Mode 2 formless block format	56
Table 23 — Mode 2 form 1 data format	56
Table 24 — Mode 2 Formed Sector Sub-header Format	57
Table 25 — Mode 2 form 2 data format	57
Table 26 — ATIP Information Types	58
Table 27 — Block Identifier bits	63
Table 28 — Track Descriptor Block (TDB) header	64
Table 29 — Track Descriptor Unit (TDU) Format	64
Table 30 — Recording Method	64
Table 31 — Structure of Control Data ECC Block	69
Table 32 — Physical Format Information	69
Table 33 — Disk Category	70
Table 34 — Disk Size	70
Table 35 — DVD-ROM Lead-in Structure	72
Table 36 — Data Area Allocation Definition	72
Table 37 — DVD-RAM Lead-in Structure	75
Table 38 — DVD-RAM Data Area Allocation Definition	75
Table 39 — DVD-RAM Unique Part of Physical Format Information	76
Table 40 — Lead-in Structure: DVD-RW and DVD-R	78
Table 41 — DVD-R/-RW Data Area Allocation Definition	79
Table 42 — DVD-RW/-R for General Unique Part of Physical Format Information	79
Table 43 — DVD-R/-RW Physical Format Information Zone	80

Table 44 — Data Area Allocation Field in DVD-R/-RW Physical Format Information	80
Table 45 — Unique Part of Physical Format Information in DVD-R/-RW Physical Format Information	81
Table 46 — DVD-R media parameters	83
Table 47 — Profile, Feature and Write Type value for each recording mode.....	85
Table 48 — Predefined Anchor points	89
Table 49 — DVD+R Format Lay-out.....	93
Table 50 — Examples of Layer Transitions	104
Table 51 — DVD+RW Media Lay-out	107
Table 52 — Generic Disc Control Block.....	115
Table 53 — Valid Values for Content Descriptor	115
Table 54 — Unknown Content Descriptor Actions.....	116
Table 55 — HD DVD-ROM Lead-in Structure	121
Table 56 — HD DVD-R Lead-in Structure	123
Table 57 — HD DVD-RAM Lead-in Structure	125
Table 58 — BD-R Disc Capacities	131
Table 59 — General PAC Format	155
Table 60 — Write Protect Control Byte	157
Table 61 — Examples of Drive/Host Interaction	158
Table 62 — Changing the Write Protect Password.....	160
Table 63 — Returned error code for commands under the Persistent-DM mode	165
Table 64 — Returned error code for READ and VERIFY commands under the DRT-DM mode.....	166
Table 65 — Returned error code for commands under the DRT-DM mode	166
Table 66 — Returned Deferred error code	167
Table 67 — DBI update for READ and VERIFY command ¹	167
Table 68 — DBI update for WRITE and WRITE AND VERIFY command ¹	167
Table 69 — Example of DBI cache zone image	170
Table 70 — Definition of PER bit and EMCDR field of Persistent-DM mode	171
Table 71 — Definition of PER bit and EMCDR field of DRT-DM mode	174
Table 72 — Stream Playback Operation Error Handling	176
Table 73 — Error Handling on Stream Recording Operation	178
Table 74 — CSS Authentication Sequence	187
Table 75 — Examples of Write Protection Associated with Media Types	190
Table 76 — Write Protect ASCQ Reporting	192
Table 77 — Commands that shall not cause delayed loads to occur	196
Table 78 — Commands that may cause delayed loads to occur.....	196
Table 79 — Commands that should not cause delayed loads to occur.....	197
Table 80 — Error Conditions and Sense Keys for Changer Mechanisms.....	197
Table 81 — GET CONFIGURATION response data format.....	201
Table 82 — Feature Header.....	201
Table 83 — Feature Descriptor generic format.....	202
Table 84 — Feature Codes	203
Table 85 — Profile List Descriptor Format.....	205
Table 86 — Profile Descriptor	205
Table 87 — Profile List.....	206

Table 88 — Core Feature Descriptor Format.....	207
Table 89 — Physical Interface Standard.....	207
Table 90 — Core Feature Commands.....	208
Table 91 — Morphing Descriptor Format.....	209
Table 92 — Morphing Feature Commands.....	209
Table 93 — Removable Medium Feature Descriptor Format.....	210
Table 94 — Loading Mechanism Type.....	211
Table 95 — Removable Medium Feature Commands.....	211
Table 96 — Write Protect Feature Descriptor.....	212
Table 97 — Write Protect Feature Commands.....	213
Table 98 — Random Readable Feature Descriptor Format.....	214
Table 99 — Random Readable Feature Commands.....	215
Table 100 — Random Readable Feature Mode Pages.....	215
Table 101 — Multi-Read Feature Descriptor Format.....	216
Table 102 — Multi-Read Feature Commands.....	216
Table 103 — CD Read Feature Descriptor Format.....	217
Table 104 — CD READ Feature Commands.....	217
Table 105 — DVD Read Feature Descriptor Format.....	218
Table 106 — DVD READ Feature Commands.....	218
Table 107 — Random Writable Feature Descriptor Format.....	219
Table 108 — Random Writable Feature Commands.....	220
Table 109 — Random Writable Feature Mode Pages.....	220
Table 110 — Incremental Streaming Writable Feature Descriptor Format.....	221
Table 111 — Command Support Required by the Incremental Streaming Writable Feature.....	222
Table 112 — Incremental Streaming Writable Feature Parameters.....	222
Table 113 — Sector Erasable Feature Descriptor Format.....	223
Table 114 — Sector Erasable Feature Commands.....	223
Table 115 — Formattable Feature Descriptor.....	224
Table 116 — Formattable Feature Commands.....	225
Table 117 — Defect Management Feature Descriptor Format.....	226
Table 118 — Defect Management Feature Commands.....	226
Table 119 — Defect Management Feature Mode Pages.....	226
Table 120 — Write Once Feature Descriptor Format.....	227
Table 121 — Write Once Feature Commands.....	227
Table 122 — Write Once Feature Mode Pages.....	228
Table 123 — Restricted Overwrite Feature Descriptor Format.....	229
Table 124 — Restricted Overwrite Feature Commands.....	229
Table 125 — Restricted Overwrite Feature Mode Pages.....	229
Table 126 — CD-RW CAV WRITE Feature Descriptor.....	230
Table 127 — CD-RW CAV Write Feature Commands.....	230
Table 128 — CD-RW CAV Write Feature Parameters.....	230
Table 129 — MRW Feature Descriptor.....	231
Table 130 — MRW Feature Commands.....	231
Table 131 — MRW Feature Parameters.....	232

Table 132 — MRW Write Feature Commands	232
Table 133 — Enhanced Defect Reporting Feature Descriptor	233
Table 134 — Relation between Number of DBI cache zones and DBI memory model type.....	234
Table 135 — Enhanced Defect Reporting Feature Commands	234
Table 136 — Enhanced Defect Reporting Feature Parameters	234
Table 137 — Enhanced Defect Reporting DRT-DM Feature Commands	234
Table 138 — Enhanced Defect Reporting small DBI cache memory model Feature Commands	235
Table 139 — DVD+RW Feature Descriptor	236
Table 140 — Command Support Required by the DVD+RW Feature with Write = 1.....	237
Table 141 — DVD+R Feature Descriptor.....	238
Table 142 — Command Support Required by the DVD+R Feature with Write = 1	238
Table 143 — Rigid Restricted Overwrite Feature Descriptor Format	239
Table 144 — Rigid Restricted Overwrite Feature Commands.....	240
Table 145 — CD Track at Once Feature Descriptor Format	241
Table 146 — CD Track at Once Feature Commands.....	242
Table 147 — CD Track at Once Feature Mode Parameters.....	242
Table 148 — CD Mastering Feature Descriptor.....	243
Table 149 — CD Mastering (Session at Once) Feature Commands.....	244
Table 150 — CD Mastering (Session at Once) Feature Mode Parameters	244
Table 151 — CD Mastering (RAW) Feature Commands.....	244
Table 152 — CD Mastering (RAW) Feature Mode Parameters.....	244
Table 153 — DVD-R/-RW Write Feature Descriptor Format	245
Table 154 — DVD-R/-RW Write Feature Commands.....	245
Table 155 — DVD-R/-RW Write Feature Parameters	245
Table 156 — Layer Jump Recording Feature Descriptor	246
Table 157 — CD-RW Media Write Support Feature Descriptor	247
Table 158 — BD-R Pseudo-OverWrite Feature Descriptor	248
Table 159 — DVD+RW DL Feature Descriptor	249
Table 160 — Command Support Required by the DVD+RW DL Feature with Write	250
Table 161 — DVD+R Double Layer Feature Descriptor.....	251
Table 162 — Command Support Required by the DVD+R Double Layer Feature	252
Table 163 — BD Read Feature Descriptor	253
Table 164 — Command Support Required by the BD Read Feature.....	254
Table 165 — BD Write Feature Descriptor	255
Table 166 — Command Support Required by the BD Write Feature.....	256
Table 167 — TSR Feature Descriptor.....	257
Table 168 — Command Support Required by the TSR Feature	257
Table 169 — TSR Feature Parameters	257
Table 170 — HD DVD Read Feature Descriptor	258
Table 171 — Command Support Required by the HD DVD Read Feature.....	258
Table 172 — HD DVD Write Feature Descriptor.....	259
Table 173 — Command Support Required by the HD DVD Write Feature for HD DVD-R.....	259
Table 174 — Command Support Required by the HD DVD Write Feature for HD DVD-RAM.....	260
Table 175 — Hybrid Disc Feature Descriptor	261

Table 176 — Hybrid Disc Feature Commands	261
Table 177 — Power Management Feature Descriptor Format	262
Table 178 — Power Management Feature Commands	262
Table 179 — Power Management Feature Parameters	262
Table 180 — S.M.A.R.T. Feature Descriptor Format	263
Table 181 — Embedded Changer Feature Descriptor Format	264
Table 182 — Embedded Changer Feature Command	264
Table 183 — Microcode Upgrade Feature Descriptor Format	265
Table 184 — Microcode Upgrade Feature Command	265
Table 185 — Timeout Feature Descriptor Format	266
Table 186 — Timeout Feature Parameter	266
Table 187 — DVD CSS Feature Descriptor Format	267
Table 188 — DVD CSS Feature Commands	267
Table 189 — Real Time Streaming Feature Descriptor Format	268
Table 190 — Real Time Streaming Feature Commands	269
Table 191 — Drive Serial Number Feature Descriptor	270
Table 192 — Drive Serial Number Feature Descriptor	271
Table 193 — Commands Required by the Media Serial Number Feature	271
Table 194 — Disc Control Blocks Feature Descriptor	272
Table 195 — Disc Control Blocks Feature Commands	272
Table 196 — DVD CPRM Feature Descriptor Format	273
Table 197 — DVD CPRM Feature Commands	273
Table 198 — Firmware Information	274
Table 199 — AACS Feature Descriptor	276
Table 200 — AACS Feature Commands	276
Table 201 — The VCPS Feature Descriptor	277
Table 202 — Commands required by the VCPS Feature	277
Table 203 — Mandatory Features for Non-removable Disks	278
Table 204 — Mandatory Features for Removable Disks	279
Table 205 — Mandatory Features for Magneto-Optical Erasable	279
Table 206 — Mandatory Features for Optical Write Once	280
Table 207 — Mandatory Features for AS-MO	280
Table 208 — Mandatory Features for CD-ROM	281
Table 209 — Mandatory Features for CD-R	281
Table 210 — Mandatory Features for CD-RW	282
Table 211 — Mandatory Features for DVD-ROM	282
Table 212 — Mandatory Features for DVD-R Sequential recording	283
Table 213 — Mandatory Features for DVD-RAM	283
Table 214 — Mandatory Features for DVD-RW Restricted Overwrite	284
Table 215 — Mandatory Features for DVD-RW Sequential recording	284
Table 216 — Mandatory Features for DVD-RW Dual Layer Sequential recording	285
Table 217 — Mandatory Features for DVD-RW Dual Layer Jump recording	285
Table 218 — Mandatory Features for DVD+RW	286
Table 219 — Mandatory Features for DVD+R	287

Table 220 — Mandatory Features for DVD+RW	288
Table 221 — Mandatory Features for DVD+R.....	289
Table 222 — Mandatory Features for BD-ROM.....	289
Table 223 — Features For BD-R SRM Profile	290
Table 224 — Features For BD-R RRM Profile.....	291
Table 225 — Mandatory Features for BD-RE	292
Table 226 — Mandatory Features for HD DVD-ROM.....	293
Table 227 — Mandatory Features for HD DVD-R.....	293
Table 228 — Mandatory Features for HD DVD-RAM	294
Table 229 — Mandatory Features for Drives Not Conforming to a Standard Profile.....	294
Table 230 — Commands for Multi-Media Drives in Alphabetic order	295
Table 231 — Commands for Multi-Media Drives in Operation code order	296
Table 232 — Features Associated with the BLANK Command.....	298
Table 233 — BLANK CDB	298
Table 234 — Blanking Types CD-RW.....	299
Table 235 — Blanking Types for DVD-RW media	300
Table 236 — Recommended errors for BLANK Command	301
Table 237 — Features Associated with the CLOSE TRACK/SESSION command.....	302
Table 238 — CLOSE TRACK/SESSION CDB.....	302
Table 239 — Recommended errors for CLOSE TRACK/SESSION Command	316
Table 240 — Features Associated with the ERASE (10) Command	317
Table 241 — ERASE (10) CDB	317
Table 242 — Recommended errors for ERASE (10) Command	318
Table 243 — Features Associated with the FORMAT UNIT Command.....	319
Table 244 — FORMAT UNIT CDB	319
Table 245 — DVD-RAM/HD DVD-RAM Defect List Handling	320
Table 246 — Format Unit Parameter List	320
Table 247 — Format List Header.....	321
Table 248 — Format Code 001b Format Descriptor.....	322
Table 249 — Format Types.....	322
Table 250 — Format Sub-type Field	324
Table 251 — Example of Default Allocations for Format Type 0, Sub-type 0	324
Table 252 — Type Dependent Parameter for Format Type 20h	327
Table 253 — Use of DCRT when MRW Formatting	328
Table 254 — Type Dependent Parameter for Format Type 26h	329
Table 255 — Format Sub-type Field	329
Table 256 — Maximum Spare Area Sizes on BD-RE.....	330
Table 257 — Type Dependent Parameter for Format Type = 32h	332
Table 258 — Format Sub-type Field	332
Table 259 — Maximum Spare Area Sizes on BD-R	333
Table 260 — Sense Key Specific Bytes in Sense Data.....	334
Table 261 — Writing During different Format States	337
Table 262 — Recommended Errors for the FORMAT UNIT Command.....	337
Table 263 — Features Associated with the GET CONFIGURATION Command.....	338

Table 264 — GET CONFIGURATION CDB	338
Table 265 — RT Field Definitions	338
Table 266 — GET CONFIGURATION response data format.....	339
Table 267 — Feature Header.....	339
Table 268 — Recommended Errors for the GET CONFIGURATION Command.....	340
Table 269 — Features Associated with the GET EVENT STATUS NOTIFICATION Command	341
Table 270 — GET EVENT STATUS NOTIFICATION CDB.....	341
Table 271 — Notification Class Request field definition	342
Table 272 — Event Status Notification Response	342
Table 273 — Event Header.....	343
Table 274 — Notification Class Field Values	343
Table 275 — General Event Descriptor Format.....	343
Table 276 — Operational Change Event Descriptor.....	344
Table 277 — Event Codes For the Operational Change Class	344
Table 278 — Operational Change	344
Table 279 — Power Management Event Descriptor.....	345
Table 280 — Power Event Field	345
Table 281 — Power Status Field	345
Table 282 — External Request Descriptor.....	346
Table 283 — External Request Events	346
Table 284 — External Request Status Codes	346
Table 285 — External Request Codes.....	347
Table 286 — Media Event Descriptor	348
Table 287 — Media Event Format	348
Table 288 — Media Status Byte Definition	348
Table 289 — Multiple Host Descriptor	350
Table 290 — Multiple Host Event Format	350
Table 291 — Multiple Host Status Codes	350
Table 292 — Multiple Host Priority Codes	351
Table 293 — Device Busy Event Descriptor.....	352
Table 294 — Device Busy Event Codes.....	352
Table 295 — Device Busy Status	352
Table 296 — Recommended Errors for GET EVENT STATUS NOTIFICATION Command	354
Table 297 — Features Associated with the GET PERFORMANCE Command	355
Table 298 — GET PERFORMANCE CDB.....	355
Table 299 — Type Field Definitions	356
Table 300 — Performance response format	356
Table 301 — Performance Header	356
Table 302 — Data Type Field Definitions for Type = 00h.....	357
Table 303 — Performance Descriptor – Nominal Performance.....	357
Table 304 — Performance Descriptor – Exceptions	358
Table 305 — Unusable Area Type values	358
Table 306 — Unusable Area Descriptor	359
Table 307 — Defect Status Descriptor.....	360

Table 308 — Write Speed Descriptor	361
Table 309 — Write Rotation Control values.....	361
Table 310 — DBI data.....	363
Table 311 — DBI data Header.....	363
Table 312 — DBI Descriptor	363
Table 313 — Error Level Type values.....	364
Table 314 — Recommended errors for GET PERFORMANCE Command	365
Table 315 — Features Associated with the INQUIRY Command.....	366
Table 316 — INQUIRY Data for ATAPI and USB Drives.....	366
Table 317 — INQUIRY Command Errors	366
Table 318 — Features Associated with the LOAD/UNLOAD MEDIUM Command.....	367
Table 319 — LOAD/UNLOAD MEDIUM CDB.....	367
Table 320 — LoUnlo/Start Operation.....	367
Table 321 — LOAD/UNLOAD MEDIUM Command Errors.....	368
Table 322 — Features Associated with the MECHANISM STATUS Command	369
Table 323 — MECHANISM STATUS CDB.....	369
Table 324 — Mechanism Status Parameter List Format.....	370
Table 325 — Mechanism Status Header	370
Table 326 — Changer State Field.....	370
Table 327 — Mechanism State Field	370
Table 328 — Slot Table Format	371
Table 329 — Recommended errors for Mechanism Status Command	371
Table 330 — Features Associated with the Mode Select Command	372
Table 331 — Recommended errors for Mode Select (10) Command	372
Table 332 — Features Associated with the Mode Sense Command	373
Table 333 — Recommended errors for Mode Sense (10) Command	373
Table 334 — Features Associated with the PREVENT ALLOW MEDIUM REMOVAL Command	374
Table 335 — PREVENT ALLOW MEDIUM REMOVAL CDB	374
Table 336 — State Selection.....	374
Table 337 — Actions for Lock/Unlock/Eject.....	375
Table 338 — Recommended errors for PREVENT ALLOW MEDIUM REMOVAL Command.....	376
Table 339 — Features Associated with the READ (10) Command	377
Table 340 — READ (10) CDB.....	377
Table 341 — Recommended errors for READ (10) Command	379
Table 342 — Features Associated with the READ (12) Command	380
Table 343 — READ (12) CDB.....	380
Table 344 — Recommended errors for READ (12) Command	382
Table 345 — Features Associated with the READ BUFFER Command	383
Table 346 — Recommended errors for READ BUFFER Command	383
Table 347 — Features Associated with the READ BUFFER CAPACITY Command	384
Table 348 — READ BUFFER CAPACITY CDB.....	384
Table 349 — Buffer Capacity Structure, when Block = 0.....	385
Table 350 — Buffer Capacity Structure, when Block = 1.....	385
Table 351 — Recommended errors for READ BUFFER CAPACITY Command	386

Table 352 — Features Associated with the READ CAPACITY Command	387
Table 353 — READ CAPACITY CDB	387
Table 354 — READ CAPACITY Response Data.....	387
Table 355 — Logical Block Address Reporting.....	388
Table 356 — Recommended errors for READ CAPACITY Command.....	389
Table 357 — Features Associated with the READ CD Command	390
Table 358 — READ CD CDB	390
Table 359 — Expected Sector type field bit definitions.....	391
Table 360 — Header Codes.....	392
Table 361 — Main Channel Selection and Mapped Values	393
Table 362 — C2 Errors Codes	394
Table 363 — Sub-Channel Selection Field Values	394
Table 364 — Formatted Q- Subchannel Data.....	396
Table 365 — Recommended errors for READ CD Command.....	397
Table 366 — Features Associated with the READ CD MSF Command.....	398
Table 367 — READ CD MSF CDB	398
Table 368 — Recommended errors for READ CD MSF Command	399
Table 369 — Features Associated with the READ DISC INFORMATION Command.....	400
Table 370 — READ DISC INFORMATION CDB	400
Table 371 — Disc Information Data Types	401
Table 372 — Disc Information Block.....	402
Table 373 — State of Last Session.....	403
Table 374 — Disc Status.....	403
Table 375 — Background Format Status Codes	404
Table 376 — Disc Type Field	405
Table 377 — OPC Table Entry	406
Table 378 — Track Resources Information Block.....	407
Table 379 — POW Resources Information Block.....	408
Table 380 — Recommended errors for READ DISC INFORMATION Command.....	409
Table 381 — Features Associated with the READ DISC STRUCTURE Command.....	410
Table 382 — READ DISC STRUCTURE CDB	410
Table 383 — Media Type Codes	410
Table 384 — Generic Format Code Definitions	411
Table 385 — READ DISC STRUCTURE Data Format (Format field = C0h)	412
Table 386 — READ DISC STRUCTURE Data Format (Format field = FFh).....	413
Table 387 — Structure List Entry	413
Table 388 — Structure Format Code Definitions for Media Type 0000b.....	414
Table 389 — READ DISC STRUCTURE Data Format (Format field = 00h).....	416
Table 390 — Disk Category Field	417
Table 391 — Maximum Rate Field.....	417
Table 392 — Layer Type Field.....	417
Table 393 — Linear Density Field.....	418
Table 394 — Track Density Field.....	418
Table 395 — Starting Physical Sector Number of Data Area field.....	418

Table 396 — DVD+RW Layer Descriptor	419
Table 397 — READ DISC STRUCTURE Data Format (Format field = 01h).....	420
Table 398 — READ DISC STRUCTURE Data Format (Format field = 02h).....	421
Table 399 — READ DISC STRUCTURE Data Format (Format field =03h).....	422
Table 400 — READ DISC STRUCTURE Data Format (Format field = 04h).....	423
Table 401 — READ DISC STRUCTURE Data Format (Format field = 05h).....	424
Table 402 — CPR_MAI Field Definition.....	424
Table 403 — READ DISC STRUCTURE Data Format (Format Field = 06h).....	426
Table 404 — READ DISC STRUCTURE Data Format (Format Field = 07h).....	427
Table 405 — READ DISC STRUCTURE Data Format (Format field = 08h).....	428
Table 406 — READ DISC STRUCTURE Data Format (Format = 09h).....	429
Table 407 — RAM-SWI Information field definition.....	430
Table 408 — READ DISC STRUCTURE Data Format (Format = 0Ah)	431
Table 409 — READ DISC STRUCTURE Data Format (Format = 0Bh).....	432
Table 410 — READ DISC STRUCTURE Data Format (Format field = 0Ch)	433
Table 411 — READ DISC STRUCTURE Data Format (Format field = 0Dh)	434
Table 412 — READ DISC STRUCTURE Data Format (Format field = 0Eh).....	435
Table 413 — READ DISC STRUCTURE Data Format (Format field = 0Fh).....	437
Table 414 — READ DISC STRUCTURE Data Format (With Format field = 10h).....	438
Table 415 — READ DISC STRUCTURE Data Format (With Format field = 11h).....	439
Table 416 — READ DISC STRUCTURE Data Format (With Format field = 12h).....	440
Table 417 — READ DISC STRUCTURE Data Format (With Format field = 15h).....	441
Table 418 — READ DISC STRUCTURE Data Format (With Format field = 19h).....	442
Table 419 — READ DISC STRUCTURE Data Format (With Format field = 1Ah)	443
Table 420 — READ DISC STRUCTURE Data Format (With Format field = 20h).....	444
Table 421 — READ DISC STRUCTURE Data Format (With Format field = 21h).....	445
Table 422 — READ DISC STRUCTURE Data Format (With Format field = 22h).....	446
Table 423 — READ DISC STRUCTURE Data Format (With Format field = 23h).....	447
Table 424 — READ DISC STRUCTURE Data Format (With Format field = 24h).....	448
Table 425 — Generic Disc Control Block.....	449
Table 426 — Valid Values for Content Descriptor	449
Table 427 — Unknown Content Descriptor Actions.....	450
Table 428 — WDCB Format	450
Table 429 — Write Protect Actions Field	451
Table 430 — SDCB Format	452
Table 431 — Disc Control Block (FFFFFFFFh)	453
Table 432 — READ DISC STRUCTURE Data Format (Format field = 31h).....	454
Table 433 — READ DISC STRUCTURE Data Format (With Format field = 80h).....	455
Table 434 — READ DISC STRUCTURE Data Format (With Format field = 81h).....	456
Table 435 — READ DISC STRUCTURE Data Format (With Format field = 82h).....	457
Table 436 — READ DISC STRUCTURE Data Format (With Format field = 83h).....	458
Table 437 — READ DISC STRUCTURE Data Format (With Format field = 90h).....	459
Table 438 — Format-layer Type Code Definitions.....	459
Table 439 — BD Format Code Definitions.....	460

Table 440 — BD Structure Format Code 00h: Disc Information.....	461
Table 441 — Disc Information Data Format.....	461
Table 442 — General DI Unit Format	461
Table 443 — BD Structure Format Code 08h: Disc Definition Structure	463
Table 444 — Format of the DDS.....	463
Table 445 — BD Format Structure Code 09h: Cartridge Status.....	464
Table 446 — Format Code 0Ah: Spare Area Information.....	465
Table 447 — BD Structure Format Code 12h: Defect List.....	466
Table 448 — General DFL Format.....	467
Table 449 — PAC ID and Format Number in CDB Address Field.....	468
Table 450 — PAC ID and Format Number Fields.....	468
Table 451 — Returned Data Format for PAC ID/Format = 000000h/00h.....	469
Table 452 — Returned Data Format for 000001h ≤ PAC ID ≤ FFFFFFFh.....	469
Table 453 — Returned Data Format for PAC ID = FFFFFFFFh.....	470
Table 454 — Primary PAC	471
Table 455 — DWP PAC	472
Table 456 — Recommended errors for READ DISC STRUCTURE Command.....	473
Table 457 — Features Associated with the READ FORMAT CAPACITIES Command.....	474
Table 458 — READ FORMAT CAPACITIES CDB	474
Table 459 — READ FORMAT CAPACITIES Data Format.....	475
Table 460 — Capacity List Header	475
Table 461 — Current/Maximum Capacity Descriptor	476
Table 462 — Descriptor Types	476
Table 463 — Returned Current/Maximum Descriptor for Combination of Drive and Media.....	476
Table 464 — Formattable Capacity Descriptor Format	477
Table 465 — Format Types.....	478
Table 466 — Recommended errors for READ FORMAT CAPACITIES Command.....	480
Table 467 — Features Associated with the READ TOC/PMA/ATIP Command.....	481
Table 468 — READ TOC/PMA/ATIP CDB.....	481
Table 469 — Format Field Values	482
Table 470 — READ TOC/PMA/ATIP Data list, general definition.....	483
Table 471 — READ TOC/PMA/ATIP response data (Format = 0000b).....	484
Table 472 — Track Start Addresses for CD-MRW Discs	485
Table 473 — Track Start Addresses for DVD+MRW Discs	485
Table 474 — Fabrication of TOC Form 0 for Single Session DVD	486
Table 475 — Response Format 0: Data Returned for BD-ROM disc	487
Table 476 — BD-R Track Translation for READ TOC/PMA/ATIP	488
Table 477 — Response Format 0: Data Returned for formatted BD-R discs.....	489
Table 478 — READ TOC/PMA/ATIP response data (Format = 0001b).....	490
Table 479 — TOC Data Format 1: Data Returned for non-CD Discs.....	491
Table 480 — READ TOC/PMA/ATIP response data (Format = 0010b).....	492
Table 481 — TOC Track Descriptor Format, Q Sub-channel.....	493
Table 482 — POINT Field.....	494
Table 483 — Disc Type Byte Format.....	494

Table 484 — READ TOC/PMA/ATIP response data (Format = 0011b)	495
Table 485 — READ TOC/PMA/ATIP response data (Format = 0100b)	496
Table 486 — READ TOC/PMA/ATIP response data (With Format Field = 0101b)	499
Table 487 — Recommended errors for READ TOC/PMA/ATIP Command	499
Table 488 — Features Associated with the READ TRACK INFORMATION Command	500
Table 489 — READ TRACK INFORMATION CDB.....	500
Table 490 — Addressed Track (T_A) According to LBA/Track/Session Number Field.....	501
Table 491 — Track Information Block.....	503
Table 492 — LJRS Field Definition	504
Table 493 — Track Mode Definition.....	505
Table 494 — RT Bit Definition.....	505
Table 495 — Blank Bit Definition	506
Table 496 — Packet/Inc Bit Definition.....	506
Table 497 — FP bit Definition	506
Table 498 — Write Parameter Restrictions due to Track State	507
Table 499 — Track Status Indications	508
Table 500 — CD Data Modes	509
Table 501 — Next Writable Address Definition.....	510
Table 502 — Recommended Errors for the Read Track Information Command.....	514
Table 503 — REPAIR TRACK CDB	515
Table 504 — Recommended errors for REPAIR TRACK Command	516
Table 505 — Features Associated with the REPORT KEY Command	517
Table 506 — REPORT KEY CDB.....	517
Table 507 — KEY Class Definition	518
Table 508 — Key Format Code definitions for REPORT KEY Command (Key Class 0).....	519
Table 509 — REPORT KEY Data Format (With KEY Format = 000000b, Key Class = 0)	520
Table 510 — REPORT KEY Data Format (With KEY Format = 000001b, Key Class = 0)	520
Table 511 — REPORT KEY Data Format (With KEY Format = 000010b, Key Class = 0)	521
Table 512 — REPORT KEY Data Format (With KEY Format = 000100b, Key Class = 0)	522
Table 513 — REPORT KEY Data Format (With KEY Format = 000101b, Key Class = 0)	523
Table 514 — REPORT KEY Data Format (With KEY Format = 001000b, Key Class = 0)	524
Table 515 — Type Code Field Definitions	524
Table 516 — RPC Scheme field Definition	524
Table 517 — REPORT KEY Data Format (With Key Format = 010001b, Key Class = 0)	525
Table 518 — Key Format Code definitions for REPORT KEY Command (Key Class 1).....	526
Table 519 — REPORT KEY Data Format (With KEY Format = 000000b, Key Class = 2)	527
Table 520 — REPORT KEY Data Format (With KEY Format = 000001b, Key Class = 2)	528
Table 521 — REPORT KEY Data Format (With KEY Format = 000010b, Key Class = 2)	529
Table 522 — REPORT KEY Data Format (With KEY Format = 100000b, Key Class = 2)	530
Table 523 — REPORT KEY Data Format (With KEY Format = 100001b, Key Class = 2)	531
Table 524 — VCPS Functions for REPORT KEY.....	532
Table 525 — VCPS Key Class REPORT KEY returned data, DKB	533
Table 526 — VCPS Key Class REPORT KEY returned data, Device ID	534
Table 527 — VCPS Key Class REPORT KEY returned data, Key Contribution.....	535

Table 528 — VCPS Key Class REPORT KEY returned data, DKB Hash & Unique ID	536
Table 529 — VCPS Key Class REPORT KEY returned data, DKB Hash & Unique ID	537
Table 530 — Recommended errors for REPORT KEY Command.....	538
Table 531 — Features Associated with the REQUEST SENSE Command.....	539
Table 532 — Recommended errors for REQUEST SENSE Command	539
Table 533 — Features Associated with the RESERVE TRACK Command	540
Table 534 — RESERVE TRACK CDB.....	540
Table 535 — RMZ bit definition.....	540
Table 536 — Reservation Size form of Logical Track Reservation Parameter	541
Table 537 — LBA form of Logical Track Reservation Parameter	541
Table 538 — Track Reservation on CD-R/RW Media	543
Table 539 — Track Reservation on DVD-R/-RW Media.....	543
Table 540 — Recommended errors for RESERVE TRACK Command	545
Table 541 — SEEK (10) CDB	546
Table 542 — Recommended errors for SEEK (10) Command.....	547
Table 543 — Features Associated with the SEND CUE SHEET Command.....	548
Table 544 — SEND CUE SHEET CDB	548
Table 545 — Cue Sheet format	549
Table 546 — Sample CUE SHEET	549
Table 547 — Cue Sheet Data	550
Table 548 — CTL/ADR byte.....	550
Table 549 — Control Field	550
Table 550 — ADR Field	551
Table 551 — Data Form Byte.....	551
Table 552 — SCMS Byte	551
Table 553 — CD (CD-DA).....	552
Table 554 — CD-DA Data format (1 Sample).....	552
Table 555 — CD-ROM mode 1	552
Table 556 — CD-ROM XA, CD-I.....	553
Table 557 — CD-ROM Mode 2.....	553
Table 558 — Data Form of Sub-channel	554
Table 559 — Media Catalog Number (N1..N13).....	555
Table 560 — ISRC (I1..I12).....	556
Table 561 — Recommended errors for SEND CUE SHEET Command	556
Table 562 — Features Associated with the SEND DISC STRUCTURE Command.....	557
Table 563 — SEND DISC STRUCTURE CDB	557
Table 564 — Media Types	558
Table 565 — Format Field Definition for Media Type = 0 (DVD and HD DVD)	558
Table 566 — Format Field Definition for Media Type = 1 (BD).....	558
Table 567 — SEND DISC STRUCTURE Parameter List (Format = 04h)	559
Table 568 — SEND DISC STRUCTURE Parameter List (Format = 05h)	560
Table 569 — CPR_MAI Field Definitions	560
Table 570 — CGMS Field Values	561
Table 571 — SEND DISC STRUCTURE Parameter List (Format = 0Fh).....	562

Table 572 — SEND DISC STRUCTURE Parameter List (Format = 20h)	563
Table 573 — SEND DISC STRUCTURE Parameter List (Format = 21h)	564
Table 574 — SEND DISC STRUCTURE Parameter List (Format = 22h)	565
Table 575 — SEND DISC STRUCTURE Parameter List (Format = 23h)	566
Table 576 — SEND DISC STRUCTURE Parameter List (Format = 24h)	567
Table 577 — SEND DISC STRUCTURE Parameter List (Format field = 30h)	568
Table 578 — WDCB Management Examples	569
Table 579 — SEND DISC STRUCTURE Parameter List (Format Field = C0h).....	570
Table 580 — Physical Access Control Send Parameter List	571
Table 581 — DWP PAC	572
Table 582 — Recommended errors for SEND DISC STRUCTURE Command.....	573
Table 583 — Features Associated with the SEND KEY Command	574
Table 584 — SEND KEY CDB	574
Table 585 — Key Class.....	575
Table 586 — Key Format Code definitions for SEND KEY Command	575
Table 587 — SEND KEY Parameter List (KEY Format field =000001b).....	576
Table 588 — SEND KEY Parameter List (KEY Format field =000011b).....	577
Table 589 — SEND KEY Parameter List (KEY Format field =000110b).....	578
Table 590 — Key Format definitions for SEND KEY command (Key Class = 02h)	579
Table 591 — SEND KEY Parameter List (With KEY Format = 000001b, Key Class = 02h).....	579
Table 592 — SEND KEY Parameter List (With KEY Format = 000010b, Key Class = 02h).....	580
Table 593 — VCPS Functions for SEND KEY	581
Table 594 — VCPS Key Class SEND KEY parameter list, Authorization Key	582
Table 595 — VCPS Key Class SEND KEY parameter list, Key Contribution.....	583
Table 596 — Recommended errors for SEND KEY Command.....	584
Table 597 — Features Associated with the SEND OPC INFORMATION Command	585
Table 598 — SEND OPC INFORMATION CDB	585
Table 599 — Drive Action with Combinations of DoOPC, Exclude0, and Exclude1	586
Table 600 — SEND OPC INFORMATION Parameter List	586
Table 601 — Recommended errors for SEND OPC INFORMATION Command.....	587
Table 602 — Features Associated with the SET CD SPEED Command	588
Table 603 — SET CD SPEED CDB	588
Table 604 — Rotational Control Parameter	588
Table 605 — Recommended errors for SET CD SPEED Command	589
Table 606 — Features Associated with the SET READ AHEAD Command	590
Table 607 — SET READ AHEAD CDB.....	590
Table 608 — Recommended errors for SET READ AHEAD Command	591
Table 609 — Features Associated with the SET STREAMING Command	592
Table 610 — SET STREAMING CDB.....	592
Table 611 — Type field definition.....	592
Table 612 — Performance Descriptor.....	593
Table 613 — DBI cache zone Descriptor.....	594
Table 614 — DBI cache zone Header	595
Table 615 — DBI cache zone Descriptor(s).....	595

Table 616 — Recommended errors for SET STREAMING Command	595
Table 617 — Features Associated with the START STOP UNIT Command	596
Table 618 — START STOP UNIT CDB	596
Table 619 — Power Conditions	597
Table 620 — LoEj and Start Meanings when Power Conditions = 0	597
Table 621 — Operations of the START STOP UNIT command	598
Table 622 — Load/Eject Actions	598
Table 623 — Recommended errors for START STOP UNIT Command	599
Table 624 — Features Associated with the SYNCHRONIZE CACHE Command	600
Table 625 — SYNCHRONIZE CACHE CDB	600
Table 626 — Recommended errors for SYNCHRONIZE CACHE Command	601
Table 627 — Features Associated with the TEST UNIT READY Command	602
Table 628 — Recommended errors for TEST UNIT READY Command	602
Table 629 — Features Associated with the VERIFY (10) Command	603
Table 630 — VERIFY (10) CDB	603
Table 631 — Recommended errors for VERIFY (10) Command	604
Table 632 — Features Associated with the WRITE (10) Command	605
Table 633 — WRITE (10) CDB	605
Table 634 — LBA to MSF translation	607
Table 635 — Recommended errors for WRITE (10) Command	609
Table 636 — Features Associated with the WRITE (12) Command	610
Table 637 — WRITE (12) CDB	610
Table 638 — Recommended errors for WRITE (12) Command	612
Table 639 — Features Associated with the WRITE AND VERIFY (10) Command	613
Table 640 — WRITE AND VERIFY (10) CDB	613
Table 641 — Recommended errors for WRITE AND VERIFY (10) Command	614
Table 642 — Features Associated with the WRITE BUFFER Command	615
Table 643 — WRITE BUFFER Command Errors	615
Table 644 — Mode Parameter List	617
Table 645 — Mode Parameters Header	617
Table 646 — Mode Pages for MM Drives	618
Table 647 — Mode Page Format	618
Table 648 — Features Associated with the READ/WRITE Error Recovery Mode Page	620
Table 649 — Read/Write Error Recovery Parameters Mode Page Format	620
Table 650 — CD-ROM Devices, error recovery description	623
Table 651 — DVD Devices, Error Recovery Description	626
Table 652 — Relationship of PER and EMCDR when Enhanced Defect Reporting Feature is current	627
Table 653 — Features Associated with the MRW Mode Page	629
Table 654 — MRW Mode Page	629
Table 655 — Features Associated with the Write Parameters Mode Page	630
Table 656 — Write Parameters Page	631
Table 657 — Use of BUFE bit	631
Table 658 — Write Type Field	633
Table 659 — Multi-session Field Definition	633

Table 660 — Data Block Type Codes (CD)	635
Table 661 — Session Format Codes	636
Table 662 — Media Catalog Number Format	637
Table 663 — International Standard Recording Code Format	637
Table 664 — Caching mode page Format	638
Table 665 — Features Associated with the Power Condition mode page	639
Table 666 — Features Associated with the Informational Exceptions Control mode page	640
Table 667 — Features Associated with the Timeout and Protect Page	641
Table 668 — Timeout & Protect Page	641
Table A.1 — ATAPI Command Packet containing a 6-Byte CDB	643
Table A.2 — ATAPI Command Packet containing a 10-Byte CDB	644
Table A.3 — ATAPI Command Packet containing a 12-Byte CDB	644
Table A.4 — Example Reset Function Mapping in ATAPI	645
Table B.1 — Example Reset Function Mapping in SCSI	648
Figure C.1 — Mass storage interface block diagram	650
Table D.1 — Bulk-Only Mass Storage Reset	657
Table D.2 — Get Max LUN	658
Table D.3 — Device Descriptor	659
Table D.4 — Configuration Descriptor	660
Table D.5 — Bulk-Only Data Interface Descriptor	661
Table D.6 — Bulk-In Endpoint Descriptor	661
Table D.7 — Bulk-Out Endpoint Descriptor	662
Table D.8 — Command Block Wrapper	662
Table D.9 — Command Status Wrapper	663
Table D.10 — Command Block Status Values	664
Table E.11 — Block Descriptor Block Sizes for Read	666
Table E.1 — READ TOC/PMA/ATIP CDB - Legacy Version	667
Table E.2 — Format Field Values	667
Table F.1 — Unit Attention Conditions	670
Table F.2 — CDB or Parameter Validation Errors	671
Table F.3 — Readiness Errors	672
Table F.4 — Protocol Errors	673
Table F.5 — General Media Access Errors	674
Table F.6 — Errors Associated with Reading	675
Table F.7 — Errors Associated with Writing	676
Table F.8 — Hardware Failures	678
Table F.9 — Errors Associated with non-ATAPI Environments	679
Table F.10 — Drive Sense Key, ASC and ASCQ Assignments	680
Table I.1 — Power Management Model States	689
Table I.2 — State Transition Events and Status	693
Table I.3 — Effects of Initiator Commands on Timers	694
Table I.4 — Effects of Initiator Commands on Timers (cont.)	695

Figures

Figure 1 — Typical MM Disc	27
Figure 2 — General Spiral Structure	28
Figure 3 — General Single Layer Structure	28
Figure 4 — General Dual Layer PTP Structure.....	28
Figure 5 — General Dual Layer OTP Structure	29
Figure 6 — Content of a Recordable Unit.....	29
Figure 7 — Disc, Session and Logical Track Decomposition	33
Figure 8 — Adjustment of Command Termination Time on Different Media	43
Figure 9 — Single Session disc	48
Figure 10 — Multi-Session Recorded Disc	48
Figure 11 — Q Sub-channel Mode-1 Format recorded in Program Area	50
Figure 12 — Q Sub-channel Mode-2 Format.....	50
Figure 13 — Q Sub-channel, Mode-3 Format.....	51
Figure 14 — Q Sub-channel Mode-1 Format recorded in Lead-in.....	52
Figure 15 — Q Sub-channel Mode-5 Format recorded in Lead-in.....	53
Figure 16 — Synchronization Field pattern.....	54
Figure 17 — ATIP Data	58
Figure 18 — Time Codes in CD-R and CD-RW Pre-groove.....	59
Figure 19 — CD-R Volume 1 and CD-RW Structure	60
Figure 20 — Multi-Speed and High capacity CD-R Structure	61
Figure 21 — PMA, Q Sub-channel.....	61
Figure 22 — Packet Format	63
Figure 23 — Logical Layout of a DVD Data Sector	67
Figure 24 — ID Field	67
Figure 25 — ECC Block Structure	68
Figure 26 — General Layout of Lead-in Area	68
Figure 27 — ID Field for DVD-ROM.....	71
Figure 28 — Zoning of DVD-RAM media	73
Figure 29 — ID Field for DVD-RAM	74
Figure 30 — DVD-RAM Logical Layout	76
Figure 31 — ID Field for DVD-R/-RW	77
Figure 32 — Structure of Extra Border Zone	81
Figure 33 — Border Zone and Borderd Area	82
Figure 34 — Physical Overview of Layers	83
Figure 35 — DVD-R DL ID Field Details	84
Figure 36 — RZone structure for Layer Jump recording	85
Figure 37 — Blank Areas and RZone Shape.....	86
Figure 38 — Border Zone Structure for DVD-R Dual Layer media.....	87
Figure 39 — Example of Layer Jump Recording	87
Figure 40 — LJB Structure of Invisible/Incomplete RZone	88
Figure 41 — Regular Interval Layer Jump	89
Figure 42 — Incomplete RZone closing when NWA is on L0	90
Figure 43 — Disc Final Closure in Layer Jump Recording Mode	90

Figure 44 — DVD+R ID Field Details	92
Figure 45 — General Layout of a Multi-Session DVD+R.....	95
Figure 46 — Zones of a Session.....	96
Figure 47 — DVD+R DL ID Field Details	99
Figure 48 — Logical Layout of a DVD+R DL Disc	100
Figure 49 — Blank and Recorded Structure of a DVD+R DL Disc.....	101
Figure 50 — Example of a DVD+R DL Disc	102
Figure 51 — Preferred Single Layer Recording.....	102
Figure 52 — Run-in ECC Blocks in L1 Middle Zone	103
Figure 53 — Example: Crossing the Layers During Recording	103
Figure 54 — Finalization Areas on DVD+R DL.....	104
Figure 55 — DVD+RW ID Field	106
Figure 56 — DVD+RW DL ID Field Details.....	109
Figure 57 — Logical Layout of a DVD+RW DL Disc.....	110
Figure 58 — Foreground part of the format process.....	112
Figure 59 — Compatibility Stop Example	112
Figure 60 — De-ice first increment	113
Figure 61 — De-ice second increment.....	113
Figure 62 — Finalization part of the format process	113
Figure 63 — Start Background part of format process	114
Figure 64 — Background part of format process	114
Figure 65 — Finalization part of the format process	114
Figure 66 — The Areas of a HD DVD Medium	117
Figure 67 — Logical Layout of a HD DVD Data Sector	118
Figure 68 — HD DVD ID Field	118
Figure 69 — HD DVD ECC Block Structure.....	119
Figure 70 — General Layout of Lead-in area.....	120
Figure 71 — ID Field for HD DVD-ROM	121
Figure 72 — ID Field for HD DVD-R	122
Figure 73 — Single Layer, Single Sided Disc	124
Figure 74 — ID Field for HD DVD-RAM.....	125
Figure 75 — HD DVD-RAM Zoning	126
Figure 76 — Layout of Single Layer BD-ROM Information Zone.....	128
Figure 77 — Layout of Dual Layer BD-ROM Information Zone	128
Figure 78 — BD-ROM Information Zone.....	129
Figure 79 — Primary Zones of a Single Layer BD-R	131
Figure 80 — Primary Zones of a Dual Layer BD-R.....	131
Figure 81 — BD-R Information Zones.....	132
Figure 82 — SL BD-R Information Zone	134
Figure 83 — TDMA Allocation on SL BD-R	134
Figure 84 — DL BD-R Information Zones	135
Figure 85 — TDMA Allocation on DL BD-R	135
Figure 86 — TDMA Access Indicators on Single Layer Disc.....	136
Figure 87 — TDMA Access Indicators on Dual Layer Disc	137

Figure 88 — Logical to Physical Addressing on Single Layer	140
Figure 89 — Logical to Physical Addressing on Dual Layer	140
Figure 90 — Status of a BD-R Disc After Fomattting in SRM.....	141
Figure 91 — Status of BD-R Disc After First RESERVE TRACK Command	141
Figure 92 — Status of BD-R Disc Multiple RESERVE TRACK Commands.....	141
Figure 93 — Status of BD-R Disc after Closing Session 1	142
Figure 94 — Status after Formatting SRM+POW	143
Figure 95 — Create, Write, and Close Small Outer Logical Track	143
Figure 96 — Status after Splitting Logical Track 1.....	144
Figure 97 — Status after Splitting Logical Track 2.....	144
Figure 98 — Status after Writing to each Logical Track	145
Figure 99 — Status after LOW to LBA 256	145
Figure 100 — Status after writing to Logical Track 1	146
Figure 101 — Status after LOW of LBA 256	146
Figure 102 — Layout of Single Layer BD Disc.....	148
Figure 103 — Layout of Dual Layer BD-RE Disc.....	149
Figure 104 — BD-RE Information Zone	150
Figure 105 — Layout of Single Layer BD-RE Disc	152
Figure 106 — Layout of Dual Layer BD-RE Disc.....	153
Figure 107 — Physical and Virtual Write Protect State Diagram.....	159
Figure 108 — General Structure of MRW Candidate Media.....	161
Figure 109 — Main Areas Defined by MRW	161
Figure 110 — Example of DBI memory blocks	169
Figure 111 — Example of defect level transition.....	173
Figure 112 — Example of Data Allocation in case of Linear Replacement	177
Figure 113 — An example of data allocation on the Stream recording operation	177
Figure 114 — Buffered Data Status	180
Figure 115 — Initial conditions prior to starting TSR recording	183
Figure 116 — Recording Begins	183
Figure 117 — Recording continues with no discovered defects	184
Figure 118 — Defects appear in the Error Report Window	184
Figure 119 — Last Chance to Notify Host of Defects	185
Figure 120 — Error Report Window Range is beyond known defects.....	185
Figure 121 — Media Changer Mechanism Model.....	193
Figure 122 — Changer State Diagram.....	195
Figure 123 — Example of a Hybrid Disc.....	198
Figure 124 — Comparison of disc exchange and Format-layer change	199
Figure 125 — State diagram of Format-layer changing.....	200
Figure 126 — Execution of a command that may cause Drive Busy.....	353
Figure 127 — Location of Sub-channel Data	554
Figure I.1 — Power Management STATE Diagram	691

Forward

(This foreward is not part of American National Standard INCITS ***-****.)

This standard defines the command set to access multi-media features for all classes of SCSI devices. The applicable clauses of this standard when used in conjunction with SCSI Primary Commands and other applicable command set documents pertaining to the subject device class, define the full standard set of commands available for that device in a SCSI environment.

Current NCITS practice is to make Technical Information Bulletins available through:

Global Engineering	Telephone:	303-792-2181 or
15 Inverness Way East	Toll Free:	800-854-7179
Englewood, CO 80112-5704	Facsimile:	303-792-2192

Requests for interpretation, suggestions for improvement and addenda, or defect reports are welcome. They should be sent to the NCITS Secretariat, National Committee for Information Technology Standards, Information Technology Institute, 1250 Eye Street, NW, Suite 200, Washington, DC 20005-3922.

This standard was processed and approved for submittal to ANSI by the National Committee for Information Technology Standards (NCITS). Committee approval of the standard does not necessarily imply that all committee members voted for approval. At the time of it approved this standard, NCITS had the following members:

<<Insert NCITS member list>>

Technical Committee T10 on Lower Level Interfaces, which developed and reviewed this standard, had the following members:

<<Insert T10 member list>>

American National Standard
for Information Technology –

SCSI Multimedia Commands – 5 (MMC–5)

1 Scope

This standard defines a set of SCSI command descriptor blocks that are useful in accessing and controlling devices with a peripheral device type set to 5.

This command set is transport independent and may be implemented across a wide variety of environments for which a SCSI transport protocol has been defined. To date, these include Parallel SCSI, ATA/ATAPI, Serial ATA, Universal Serial Bus (USB versions 1.1 and 2.0), and High Performance Serial Bus (IEEE 1394, 1394A, and 1394B).

The command set described has been selected for correct operation when the physical interface is ATA with the ATAPI command protocol. Although some commands are also described in [SPC-3], reduced descriptions are also in this standard for the purpose of profiling mandatory and optional command features as applied to multi-media devices.

The objective of this command set is to provide for the following:

1. A definition of the command formats and functions independent of delivery, protocol/signaling or transport mechanism. Architectural constraints regarding command functions, over the various transports, are addressed in the document specific to the physical transport.
2. Standardized access to common features of devices employed in multi-media applications.
3. System software/firmware independence across device classes and physical interfaces. Provision is made for the addition of special features and functions through the use of vendor-specific options.
4. To provide compatibility such that properly conforming devices may inter-operate with subsequent devices.

The Multi-Media Commands - 5 (MMC-5) standard is divided into several clauses:

Clause 1 (this clause) is the scope.

Clause 2 contains lists of documents that may be needed by the reader for the correct understanding of this standard.

Clause 3 contains Definitions, Symbols, Abbreviations, and Conventions. This is a glossary of terminology used in this standard.

Clause 4 describes modeling for the various media-oriented behaviors that the Host may witness from the device. This also provides an overview of internal drive operation to the Host application developer.

Clause 5 defines the features and profiles of MMC devices. Features describe Drive capability while profiles define a general device view.

Clause 6 defines commands that may be implemented by MMC device. Commands are described from the Host's point of view

Clause 7 defines the parameter data formats that may be implemented by MMC devices. Inputs required by the drive are not always a part of a command. Inputs associated with mode of operation are readable and sometimes writable.

The annexes provide information to assist with implementation of this standard.

This page is intentionally blank

2 References

2.1 Normative References

The following standards contain provisions that, by reference in the text, constitute provisions of this standard. At the time of publication, the editions indicated were valid. All standards are subject to revision, and parties to agreements based on this standard are encouraged to investigate the possibility of applying the most recent editions of the standards listed below.

2.2 Approved References

Copies of the following documents may be obtained from ANSI: approved ANSI standards, approved and draft international and regional standards (ISO, IEC, CEN/CENELEC, ITUT), and approved and draft foreign standards (including BSI, JIS, and DIN). For further information, contact ANSI Customer Service Department at 212-642-4900 (phone), 212-302-1286 (fax) or via the World Wide Web at <http://www.ansi.org>.

ANSI NCITS.336:2000	SPI-3	SCSI Parallel Interface – 3
ANSI NCITS.351:2001	SPC-2	SCSI-3 Primary Commands
ANSI INCITS 401:2005	MMC-4	SCSI-3 Multi-Media Command Set – 4
ANSI NCITS.306:1998	SBC	SCSI-3 Block Command Set
ANSI NCITS.325:1998	SBP-2	SCSI Serial Bus Protocol – 2
ANSI INCITS 397-2005	ATA-7	AT Attachment with Packet Interface – 7 Volume 1: ATA Command Set Volume 2: Parallel ATA Volume 3: Serial ATA
ANSI/IEEE Std 1394A-2000	1394A	High Performance Serial Bus
FIPS 197	AES	Advanced Encryption Standard, Federal Information Processing Standards Publication 197.
ISO/IEC 646:1991	ASCII	Information technology - ISO 7-bit coded character set for information interchange (third edition). <i>See also: ANSI INCITS 4-1986 (R2002) Information Systems - Coded Character Sets - 7-Bit American National Standard Code for Information Interchange (7-Bit ASCII)</i>
IEC 908:1987		Compact Disc Digital Audio System.
ISO/IEC 3901:2001	ISRC	International Standard Recording Code
ISO/IEC 10149:1995		Information Technology-Data Interchange on Read-only 120 mm Optical Data Discs (CD-ROM).
ISO/IEC 16448:2002		Information technology -- 120 mm DVD -- Read-only disk
ISO/IEC 16449:2002		Information technology - 80 mm DVD - Read-only disk
ISO/IEC 16824:1999		Information technology -- 120 mm DVD rewritable disk
ECMA 167, 3 rd Edition		Volume and File Structure for Write-Once and Rewritable Media using Non-Sequential Recording for Information Interchange
ECMA 330		120 mm (4,7 Gbytes per side) and 80 mm (1,46 Gbytes per side) DVD Rewritable Disk (DVD-RAM)
ECMA 337		120 mm 4,7GB and 80 mm 1,46 GB DVD ReWritable Disk (DVD+RW)
ECMA 338		80 mm (1,46 Gbytes per side) and 120 mm (4,70 Gbytes per side) DVD Re-recordable Disk (DVD-RW)

2.3 References under development

At the time of publication, the following referenced standards were still under development. For information on the current status of the document, or regarding availability, contact the relevant standards body or other organization as indicated.

INCITS T10/1416D	SPC-3	SCSI Primary Command Set – 3
INCITS T10/1417D	SBC-2	SCSI Block Command Set – 2
INCITS T10/1467D	SBP-3	SCSI Serial Bus Protocol – 3
INCITS T13/1532D	ATA-8	AT Attachment with Packet Interface 8 (ATA/ATAPI-8) Volume 1: ATA Command Set Volume 2: Parallel ATA Volume 3: Serial ATA

2.4 Other References

The following are published by the NV Philips and Sony Corporation and are available from Philips Electronics NV (for availability, consult www.licensing.philips.com):

CD-Ref1	System Description Compact Disc Digital Audio (aka "Red Book"), See also [IEC 908:1987]
CD-Ref2	Compact Disc Read Only Memory (aka "Yellow Book"), See also [ISO/IEC 10149:1995]
CD-Ref3	CD-I Full Functional Specification ("Green Book")
CD-Ref4	System Description Compact Disc Read Only Memory eXtended Architecture (CD-ROM XA)
CD-Ref5	Multi-session Compact Disc Specification
CD-Ref6	System Description Recordable Compact Disc Systems, part II: CD-R
CD-Ref7	System Description Recordable Compact Disc Systems, part II: CD-R, Volume 2: Multi-Speed
CD-Ref8	System Description Recordable Compact Disc Systems, part II: CD-R, Volume 3: High Capacity Compact Disc Recordable Disc Systems
CD-Ref9	System Description Recordable Compact Disc Systems, part III: Compact Disc ReWritable (CD-RW)
CD-Ref10	System Description Recordable Compact Disc Systems, part III Volume 2: CD-RW

The following are published by the DVD Forum (for availability, consult www.dvdforum.org):

DVD-Ref1	DVD Specification for Read-Only Disc (DVD-ROM), part 1: Physical Specifications, Ver 1.0
DVD-Ref2	DVD Specification for Recordable Disc (DVD-R), part 1: Physical Specifications, Ver 1.0
DVD-Ref3	DVD Specifications for Recordable Disc (DVD-R) for General, part 1: Physical Specifications, Ver 2.1
DVD-Ref4	DVD Specifications for Recordable Disc (DVD-R) for Authoring, part 1: Physical Specifications, Ver 2.0
DVD-Ref5	DVD Specifications for Recordable Disc for Dual Layer (DVD-R for DL) Part one Physical Specifications, Ver 3.0
DVD-Ref6	DVD Specification for Rewritable Disc (DVD-RAM), part 1: Physical Specifications, Ver 2.2
DVD-Ref7	DVD Specification for Re-recordable Disc (DVD-RW), part 1: Physical specifications, Ver 1.2
DVD-Ref8	DVD Multi Specifications, Version 1.1 (available at www.dvdforum.org)

The following are published by the DVD+RW Alliance (for availability, consult www.licensing.philips.com):

DVD+Ref1	DVD+R 4,7 Gbytes Basic Format Specifications, Version 1.11, December 2002
DVD+Ref2	DVD+RW 4,7 Gbytes Basic Format Specifications, Version 1.2, December 2002
DVD+Ref3	DVD+R 8,5 Gbytes Basic Format Specifications, Version 1.0, March 2004
DVD+Ref4	DVD+RW Dual Layer, 8,5 Gbytes Basic Format Specifications System Description part 2, volume 1; version 0.5 October 2005

The following are published by the DVD Forum (for availability, consult www.dvdforum.org):

HD DVD-Ref1	HD DVD Specification for Read-Only Disc (HD DVD-ROM), part 1: Physical Specifications, Ver 1.1
HD DVD-Ref2	HD DVD Specification for Recordable Disc (HD DVD-R), part 1: Physical Specifications, Ver 1.0
HD DVD-Ref3	HD DVD Specification for Rewritable Disc (HD DVD-RAM), part 1: Physical Specifications, Ver 1.0
HD DVD-Ref4	HD DVD Specification for High Definition Video, Ver 1.0
HD DVD-Ref5	HD DVD Specification for Rewritable/Re-recordable Discs part three Video Recording (HD DVD-VR), Ver 1.0

The following are published by the Blu-ray Disc Founders (for availability, consult www.blu-raydisc.info):

BD-Ref1	System Description Blu-ray Disc Read-only Format, Part 1: Basic Format Specifications, Version 1.3, July 2004
BD-Ref2	System Description Blu-ray Disc Recordable Format, Part 1: Basic Format Specifications, Version 1.1, December 2004
BD-Ref3	System Description Blu-ray Disc Rewritable Format, Part 1: Basic Format Specifications, Version 2.1, November 2004

The following are published by the MRW Promoters (for availability, consult www.licensing.philips.com):

MRW-Ref1	CD-MRW Defect Management & Physical Formatting Version 1.2, June 2004
MRW-Ref2	DVD+MRW Defect Management & Physical Formatting, Version 1.2, October 2005

The following is published by the Small Form Factor Industry Group (SFF) (for availability, consult www.sffcommittee.org):

Fuji-Ref1	INF-8090i Commands for Multi-Media devices, revision 5.5, June 2003
-----------	---

The following is published by the Optical Storage Technology Association (OSTA) (for availability, consult www.osta.org):

UDF-Ref1	Universal Disk Format (UDF), Revision 2.6, March 2005
----------	---

The following are published by the USB Implementers Forum (for availability, consult www.usb.org):

USB-Ref1	Universal Serial Bus Specification, Revision 2.0
USB-Ref2	Universal Serial Bus Mass Storage Class Bulk-Only Transport

Documents describing the DVD Content Scrambling System (CSS) are published by the DVD Copy Control Association and are available only to licensees. For more information consult www.dvdcca.org.

The following is published by the 4C Content Protection Working Group and are available from CPRM-licensing@4Centity.com:

CPRM-Ref1 Content Protection for Recordable Media Specification: Intel, IBM, Matsushita, Toshiba, 2000

The following are published by the Advanced Access Content System Licensing Authority (AACSLA). For more information consult www.aacsla.org.

AACS-Ref1 Advanced Access Content System: Introduction and Common Cryptographic Elements, Revision 0.90 April 14, 2005

AACS-Ref2 Advanced Access Content System: Pre-recorded Video Book, Revision 0.90 April 14, 2005

AACS-Ref3 Advanced Access Content System: Recordable Video Book, Revision 0.90 April 14, 2005

3 Definitions, Symbols, Abbreviations, and Conventions

3.1 MMC General Terms

3.1.1 Additional Sense Code (ASC)

As defined in [SPC-3], the value stored in byte 12 of the sense information is labeled the Additional Sense Code. In the case of this standard, ASC is part of a 20-bit code: SK/ASC/ASCQ that identifies a specific error or condition.

3.1.2 Additional Sense Code Qualifier (ASCQ)

As defined in [SPC-3], the value stored in byte 13 of the sense information is labeled the Additional Sense Code Qualifier. In the case of this standard, ASCQ is part of a 20 bit code: SK/ASC/ASCQ that identifies a specific error or condition.

3.1.3 Advanced Access Content System (AACS)

A system for managing content stored on the prerecorded and recorded optical media for consumer use with PCs and CE devices.

3.1.4 Appendable disc

A recordable/rewritable disc that supports a track/session recording model may be either complete or appendable. An appendable disc is either a disc with no complete sessions or a disc on which a new session may be appended to the last complete session.

3.1.5 AT Attachment (ATA)

AT Attachment defines the physical, electrical, transport, and command protocols for the internal attachment of block storage devices. See [ATA-7].

3.1.6 AT Attachment Packet Interface (ATAPI)

A device that implements the Packet command Feature set as defined in [ATA-7] is referred to as an ATAPI device.

3.1.7 Authentication Grant ID (AGID)

The Authentication Grant ID is a handle used for resource control during key management. Individual key management threads are identified through the use of AGID.

3.1.8 Block (Logical Block)

A block (or logical block) consists of only the user data part of a sector.

3.1.9 Burst Cutting Area (BCA)

The Burst Cutting Area provides a unique physical identification mark for individual DVD, HD DVD or BD media. This area is not directly addressable by the user.

3.1.10 Certification

Certification is a function defined for the Hardware Defect Management Feature. A Writable Unit is optionally written and then read. Vendor specific rules define a test for the read reliability of the writable unit. If the writable unit fails the test, the writable unit is registered into the hardware defect management system as defective. Otherwise, the writable unit is certified as good.

3.1.11 Challenge

A challenge is a data structure used during an authentication key exchange process.

3.1.12 Command Descriptor Block (CDB)

The structure of 6, 10, or 12 bytes used to communicate commands from a Host to a MM Drive.

3.1.13 Command Packet

Some transports package a SCSI CDB in a fixed size data structure that is used by the transport to communicate commands from a Host to a Drive. This structure is named a command packet.

3.1.14 Complete (Closed) session

A Complete Session is a session into which the Host is not permitted to write new user data. It may or may not be possible to append an additional session (see Finalized Disc).

3.1.15 De-Icing

Most read-only CD devices locate the groove only by the presence of data. When an ECC block on a DVD+RW medium is blank, no headers are present in any sector of the ECC block.

When no data is present, a seek is unable to find a stopping point. In these cases, it is not possible to locate any sector. A seek to any address would result in a continuous "slide" across the media as if it was covered in ice.

Writing the entire surface (formatting) ensures the presence of data and headers. This makes seeking possible. The process of writing the entire surface is called De-Icing.

3.1.16 Defect List (DFL).

Generically, a Defect List exists to map defective writable units to spare writable units.

When a BD-R disc is formatted with the Pseudo-Overwrite capability, the DFL is also used to map replacement Clusters.

3.1.17 Defect Management

Block addressable storage medium may have defects that render some sectors either temporarily or permanently unusable. Defect Management is a mechanism that provides a defect free address space to the host application.

3.1.18 Direct-overwrite

The process or capability of writing over previously written data without an erase cycle is direct-overwrite.

3.1.19 Disc/Disk

Within this standard, disc (or disk) refers to a single disc (or disk): CD, DVD, BD, or HD DVD.

3.1.20 Double Sided

A medium with two independently addressed sides is named double sided.

3.1.21 Drive

A Drive that operates as a single MM device. e.g. a CD-ROM Drive.

3.1.22 Drive Busy

A Drive is Busy if it is executing some process and is unable to accept new commands. e.g., when the Drive is currently executing a command that had an immediate bit (IMMED) set to one in its CDB, it may be unavailable to accept and process all commands.

3.1.23 Dual Layer

A dual layer disc has two separate optically sensitive layers that are accessible from one side of the disc at two different focal depths. This is sometimes referred to as double layer.

3.1.24 Embossed Area

An Embossed Area is an area on the disc where information has been stored during the disc manufacturing process by means of either a High Frequency Modulated (HFM) Groove or by means of pits and lands.

The recording in an embossed area cannot be modified by a recording device.

3.1.25 Error Correction Code (ECC)

ECC is a general term for any encoding that has the purpose of detecting and correcting errors.

3.1.26 Error Detection Code (EDC)

EDC is a general term for any encoding that has the purpose of detecting data errors.

3.1.27 Feature

A feature is an atomic unit of Drive functionality. A feature associated with a given Drive defines only a small subset of related functionality normally associated with that Drive.

3.1.28 Field

A Field is a group of two or more contiguous bits. Fields containing only one bit are referred to as the “named” bit instead of the “named” field.

3.1.29 Finalized Disc

A disc is finalized when the last session is closed with no possibility of appending a new session.

3.1.30 Format

As a noun, “format” refers to a well-defined arrangement or layout of information. Within the confines of the MMC, the verb “format” refers to a format operation started by the FORMAT UNIT command.

3.1.31 Full Certification

As a part of the execution of the FORMAT UNIT command on a rewritable disc, the Drive may certify each writable unit in each of the LBA spaces and all spare areas. This is Full Certification.

3.1.32 Hardware Defect Management

Defect Management that is implemented completely in the drive.

3.1.33 Hex

Hex is an abbreviation for the word hexadecimal. This indicates a binary value represented in base 16. The value may extend across multiple bytes.

3.1.34 Hold Track State

When a MM device enters the hold Track State the optical pick-up is maintained at an approximately constant radial position on the media.

3.1.35 Host

A Host is a SCSI device with the characteristics of a primary computing device, typically a personal computer, workstation, minicomputer, mainframe computer, or auxiliary computing device or server. A Host includes one or more SCSI Host devices.

3.1.36 Incomplete session

An Incomplete Session is a session into which the Host is permitted to write new user data.

3.1.37 Layer

The recorded information is in layers as seen from one side of a disc. There are single and dual layer discs.

3.1.38 Lead-in

The Lead-in on a MM disc is an initial part of the spiral that provides for outer to inner radius seek overshoot protection. On dual layer discs, the lead-in is always at the inner radius of its residence layer. The data content within the lead-in is different for different disc types.

3.1.39 Lead-out

The Lead-out on single layer and PTP dual layer MM discs is the final part of the spiral that provides for inner to outer radius seek overshoot protection. The data content within the lead-out typically contains no unique information.

The Lead-out on an OTP dual layer MM disc is the final part of the spiral that provides for outer to inner radius seek overshoot protection on layer 1.

3.1.40 Logical Block

The Host addressable units of data are named Logical Blocks.

3.1.41 Logical Block Address (LBA)

The LBA is the number that a Host uses to reference Logical Blocks on a block storage device.

3.1.42 Logical Sector Number (LSN)

A sector's LBA is referred to as LSN in some references.

3.1.43 Logical Track

Logical Track is a generic term for a logical subdivision of the address space of optical media.

On CD media a Logical Track is a track.

On DVD-R/-RW and HD DVD-R media a Logical Track is a RZone.

On DVD+R media a Logical Track is a Fragment.

On BD-R media in SRM a Logical Track is an SRR.

For all other media types where Logical Track is not defined, the entire user space of the media is viewed as a single Logical Track.

3.1.44 Drive Number (LUN)

The LUN is the address of a Drive via a target.

3.1.45 Magazine

This is a term for multiple disc unit/container.

3.1.46 Medium

Within this publication, medium refers to a single disc: CD, DVD, BD, or HD DVD.

3.1.47 Middle Area

The middle area is a transition zone at the outer radius of each layer of an OTP dual layer MM disc. The middle area 0 is the area that follows data zone 0 and middle area 1 is the area that follows data zone 1.

3.1.48 Mount Rainier reWritable (MRW)

Mount Rainier reWritable is a general optical media format is defined specifically for rewritable media for the purpose of providing a hardware defect management scheme without ignoring potential problems with legacy devices. When used on CD-RW media, the format is named CD-MRW. When used on DVD+RW media, the format is named DVD+MRW.

3.1.49 Optimum Power Calibration (OPC)

OPC is a procedure performed by an optical storage device to calibrate laser power. Values from this calibration are used for subsequent write operations.

3.1.50 Opposite Track Path (OTP)

An opposite track path disc is dual layer disc. The Layer 0 groove begins at the inner radius with a Lead in, followed by a data zone, and finishes with a Middle area. The Layer 1 groove begins at the outer radius with a Middle area, followed by a data zone, and finishes with a lead-out.

3.1.51 Parallel Track Path (PTP)

A parallel track path disc is a dual layer disc that has a Lead-in, user area and Lead-out in each layer respectively. The physical sector number in each layer increases to its respective Lead-out in parallel.

3.1.52 Physical Sector Number (PSN)

Each physical address space of each media type has a media specific physical sector numbering system such that each sector is numbered and the number for a given sector is unique.

3.1.53 Profile

A profile is a collection of features. The profile is a well-defined way of describing the overall capabilities of a specific Drive. More complex Drives may exhibit more than one profile.

3.1.54 Sector

In case of CD media, "Sector" refers to the data contained in one CD frame. In the CD-ROM standard (ISO/IEC 10149) the term block is used for this unit.

In the case of DVD and HD DVD media, Sector is the smallest user addressable part of the media. The user data contained within a sector is 2 048 bytes.

A BD sector contains control information, one logical block, and logical block EDC. The user data contained within a sector is 2 048 bytes.

3.1.55 Sense Key (SK)

As defined in [SPC-3], the 4-bit value stored in bits 3 - 0 of byte 2 of the sense information is labeled the Sense Key. In the case of this standard, SK is part of a 20-bit code: SK/ASC/ASCQ that identifies a specific error or condition.

3.1.56 Session

A session is a contiguous area of a CD, DVD, HD DVD, or BD Disc into which data may be recorded. Typically, a session is a collection of Logical Tracks with contiguous track numbers.

3.1.57 Single Sided

A single sided disc has exactly one recorded or recordable side.

3.1.58 Software Defect Management

Defect Management in which the defect list is managed by the host.

3.1.59 Timely, Safe Recording (TSR)

TSR is a method that the Host may use to identify defective LBAs and control the timing of replacements by the Drive's Defect Management system.

3.1.60 UDF (Universal Disk Format)

The description of a file system designed for MM recordable discs and based upon the ECMA 167, June 1997 (see also ISO/IEC 13346:1995).

3.1.61 Uninterrupted Recording

Also known as Disc-At-Once (DAO) recording, uninterrupted recording is performed without any linkage sequence. This is only possible when an entire disc is recorded in a single write stream.

3.1.62 Writable Unit

A writable media has a minimum physically writable amount of data. When expressed as an integral number of logical blocks, this is a writable unit. The writable unit is an ECC block on DVD, an HD ECC block on HD DVD, and a Cluster on BD.

3.1.63 Write-Verify

As a part of a writing process, any method that verifies that it is possible to recover written data is a Write-Verify process. Typically, a Drive performs Write-Verify on a writable unit as a part of the writing process by reading the writable unit after it has been written. The Write-Verify scheduling of writing and reading is vendor specific and is transparent to the Host.

For certain media types, it is possible to verify the written data during the write process. In such cases, a separate read pass is not required.

The Write-Verify method employed for each media type is vendor specific.

3.1.64 Zone

A zone is a physically contiguous region of a disc spiral. The Information Zone of a dual layer disc in OTP is considered physically contiguous.

3.2 CD Specific Terms

3.2.1 Absolute Time In Pre-groove (ATIP)

Address and recording information that is encoded in the wobble groove on CD-R/RW is named the Absolute time in pre-groove.

3.2.2 Binary Coded Decimal (BCD)

When a 4-bit entity is permitted to contain only values 0, 1, 2, ..., 9, the representation is Binary Coded Decimal. A byte using BCD representation contains two BCD digits. The high order decimal digit occupies bits 7 through 4 of the byte, while the low order decimal digit occupies the bits 3 through 0 of the byte. Only non-negative values may be represented.

3.2.3 C1, C2, C3

There are potentially 3 layers of error correction on CD media. CIRC contains two layers known as C1 and C2. C2 is layered on C1. When a sector is encoded as either mode 1 data or mode 2, form 1 data, there is a third layer of correction named C3.

3.2.4 CD-Text

A method for storing text information in the lead-in and data areas of a CD-DA disc is named CD-Text.

3.2.5 Compact Disc – Recordable/Rewritable (CD-R/RW)

This designates CD-R, CD-RW, or both.

3.2.6 Compact Disc (CD)

CD is a family of related optical storage media.

3.2.7 Compact Disc – Digital Audio (CD-DA)

The format for storing digital audio information on CD is referred to as Compact Disc – Digital Audio. See [IEC 908:1987].

3.2.8 Compact Disc – Read Only Memory (CD-ROM)

Formats for storing digital data on CD is referred to as Compact Disc – Read Only Memory. See [ISO/IEC 10149:1995].

3.2.9 Compact Disc – Recordable (CD-R)

A CD that is able to be written only once is named Compact Disc – Recordable.

3.2.10 Compact Disc ReWritable (CD-RW)

A CD that is able to be re-written is named Compact Disc ReWritable.

3.2.11 control field

The control field is a 4-bit field in the Q Sub-channel data on CD media indicating the type of information encoded on the current track. The information includes: audio/data, the type of audio encoding, etc.

3.2.12 Cross Interleaved Reed-Solomon Code (CIRC)

The error detection and correction technique used on all CD formats is CIRC. This is sometimes referred to as correction layer 1 (C1) and correction layer 2 (C2).

3.2.13 data mode

One byte of the header of a CD data sector contains the data mode. This indicates if data is present and if layered error correction information is present.

3.2.14 De-Icing

Most read-only CD devices locate the groove only by the presence of data. When no data is present, a seek is unable to find a stopping point. In these cases, it is not possible to locate any sector. A seek to any address would result in a continuous "slide" across the media as if it was covered in ice. This is a problem only for the random access feature.

Writing the entire surface (formatting) ensures the presence of data and headers. This makes seeking possible. The process of writing the entire surface is called De-Icing.

3.2.15 European Article Number (EAN)

EAN is a standard number registering system for CD media, controlled by the EAN International located at 145 rue Royale B, 1000 Brussels, Belgium. See also the definitions for MCN and UPC.

3.2.16 Fixed Packet Track

A fixed packet track is a CD track that contains only fixed length packets in its data area.

3.2.17 Frame

A CD frame is a physical CD sector. The F field unit of a MSF CD address is the frame field. For the Host, this is the smallest addressable unit on CD media.

3.2.18 Incremental Recording

Incremental recording on CD is any recording that requires a linkage sequence in the data stream. Packet, Track-At-Once (TAO), and Session-At-Once (SAO) recording are all incremental. Incremental recording is also used as a track relative term. TAO tracks are recorded uninterrupted, whereas tracks recorded in packets are recorded incrementally. This is reflected in the CONTROL field of mode 1 Q sub-channel.

3.2.19 Index

CD-DA discs may have sub-divisions of tracks identified by an index that varies from 00bcd through 99bcd. The index is recorded in the Q sub-channel of each sector of the track.

3.2.20 Layered Error Correction (L-EC)

L-EC is another name for C3 error correction. See C1, C2, C3.

3.2.21 Media Catalog Number (MCN)

This 13 BCD number is found in CD sub-channel in at least one out of every one hundred consecutive CD frames. The number is typically registered with a public or private service. See also the definitions for EAN and UPC.

3.2.22 Method 1 Addressing

For all CD media, method 1 addressing is a linearization of MSF addresses. If absolute location MSF is in the program area, then $LBA = 4\ 500 * M + 75 * S + F - 150$. Method 1 logical sector numbering is not defined for sectors outside of the program area.

3.2.23 Method 2 Addressing

For CD-R and CD-RW media, method 2 addressing is defined for the logical numbering of sectors on a fixed packet written disk. Link, run-in, and run-out blocks are ignored in the logical sector numbering.

3.2.24 Method 3 Addressing

Method 3 is an extension of CD method 2 addressing. It is the LBA translation method for CD-MRW formatted media.

3.2.25 Minute, Second, Frame address (MSF)

The physical address expressed as a sector count relative to either the beginning of the medium (absolute) or to the beginning of the current track (relative). As defined by the CD standards, each F field unit is one sector; each S field unit is 75 F field units; each M field unit is 60 S field units. Valid contents of F fields are binary values from 0 through 74. Valid contents of S fields are binary values from 0 through 59. Valid contents of M fields are binary values from 0 through 79.

3.2.26 Orange Book

The term "Orange Book" refers to any one of a collection of documents from Philips Electronics that describe recordable and rewritable CD systems and media: [CD-Ref7], [CD-Ref8], [CD-Ref9], and [CD-Ref10].

3.2.27 Packet

A packet on CD media is a set of recorded link, run-in, data, and run-out blocks.

3.2.28 packet size

On CD media the number of Data Blocks in a packet is the packet size.

3.2.29 packet track

A packet track is a CD track written as a concatenation of a pre-gap, written as one or two packets, followed by some non-zero number of user packets.

3.2.30 post-gap

The post-gap is a transition area located at the end of a CD track.

3.2.31 pre-gap

The pre-gap is a transition area located at the beginning of a CD track.

3.2.32 Program Area

The program area is the logical address space in a CD session.

3.2.33 Program Memory Area (PMA)

The PMA contains information about the recordings on a CD-R/RW disc.

3.2.34 Red Book

The term "Red Book" refers to the document: [CD-Ref1]. [IEC 908:1987] is the preferred reference.

3.2.35 relative MSF field

See MSF address definition.

3.2.36 Sub-channel

CD media have a main channel and a Sub-channel. The Sub-channel area has eight parts called P, Q, R, S, T, U, V, and W. The Q Sub-channel contains information useful to the controller and Drive, such as the control field and MSF address. The data rate of each Sub-channel (P, Q, etc.) is 1/192nd of that of the main channel.

3.2.37 Table of Contents (TOC)

On CD media, the TOC has information on the type of session and the starting address of the tracks. This information is encoded in the Q Sub-channel in each Lead-in area.

3.2.38 Track

Track refers to a Logical Track on CD media. Track is a historical term that is often used interchangeably with Logical Track. See Logical Track.

3.2.39 Track at Once (TAO)

On CD-R/RW media when a track, including its pre-gap, is written as a single packet, the track is said to be recorded track at once (TAO).

3.2.40 Track Descriptor Block (TDB)

On CD-R/RW media, the TDB contains information on the attributes of the current track.

3.2.41 Transition area

For CD, a transition area is a sequence of sectors at the beginning or end of tracks e.g. Pause Area, Pre-Gap, Lead-out, Post-Gap.

3.2.42 Uniform Product Code (UPC)

UPC is controlled by the UC Council, Inc., located at 1009 Lenox Drive, Suite 202 Lawrenceville, NJ 08648. See the definitions for AEN and MCN.

3.2.43 Yellow book

The term "Yellow Book" refers to the Philips Electronics document: Compact Disc Read Only Memory. The preferred reference is ISO/IEC 10149, Information Technology-Data Interchange on Read-only 120 mm Optical Data Discs (CD-ROM).

3.3 DVD and HD DVD Specific Terms

3.3.1 Address In Pre-groove (ADIP)

Address and recording information encoded in the wobble pre-groove on DVD+R/+RW is named the Address in pre-groove (ADIP).

3.3.2 Block Sync Guard Area (BSGA)

On DVD-R/-RW and ECC block is recorded following a sequential recording sequence to ensure readability of subsequent ECC blocks.

3.3.3 Border recording

Border recording is the DVD-R and HD DVD-R equivalent of multi-session recording.

3.3.4 Bordered Area

A Bordered Area is a contiguous area of a disc that contains user data which is located between Lead-in/Border-in Area and Lead-out/Border-out Area.

3.3.5 Border-in Area

A Border-in Area is the area that contains the pointer to the next Border Zone and is located immediately following Border-out.

3.3.6 Border-out Area

The area that follows each Bordered Area and contains the latest RMD copies and so on. This area is used to avoid pickup overrunning for DVD/HD DVD Drives.

3.3.7 Border Zone

Border Zone is the border-out of "Session" N and the border-in of "session N+1". The Bordered Area is the part in the middle.

3.3.8 Content Protection for Prerecorded Media (CPPM)

CPPM is a system for protecting DVD-Audio content on DVD-ROM media

3.3.9 Content Protection for Recordable Media (CPRM)

CPRM is a system for protecting audio-visual content on recordable DVD media.

3.3.10 Content Scrambling System (CSS)

CSS is an encryption system for content protection of DVD-ROM mastered for video applications.

3.3.11 Control Data Zone

The Control data zone is a structure recorded in the lead-in area of a DVD and HD DVD discs that contains information concerning structure of the disc.

The DVD Control Data Zone is comprised of 192 ECC blocks in the System Lead-in Area of a DVD disc. The content of the 16 sectors in each ECC block is repeated 192 times.

The HD DVD Control Data Zone is comprised of 192 ECC blocks in the System Lead-in Area of a HD DVD disc. The content of the 32 sectors in each Block is repeated 192 times.

3.3.12 De-icing

When an ECC block on a DVD+RW medium is blank, no headers are present in any sector of the ECC block. When no data is present, a seek is unable to find a stopping point. In these cases, it is not possible to locate any sector. A seek to any address would result in a continuous "slide" across the media as if it was covered in ice. This is a problem only for the random access feature.

Writing the entire surface (formatting) ensures the presence of data and headers. This makes seeking possible. The process of writing the entire surface is called De-Icing.

3.3.13 DVD

DVD is a family of related optical storage media and Drives.

3.3.14 DVD+R (DVD plus Recordable)

DVD+R is a wobble groove based DVD medium that is write-once.

3.3.15 DVD+RW (DVD ReWritable)

DVD+RW is a wobble groove based DVD media that is rewritable.

3.3.16 DVD-R (DVD Recordable)

DVD-R is a wobble groove based DVD medium that is write-once. This is also known as DVD-R for General.

3.3.17 DVD-RAM (DVD-Random Access Memory)

DVD -RAM is rewritable DVD media. A DVD -RAM spiral has stamped headers, thereby negating the need for full format.

3.3.18 DVD-ROM (DVD-Read Only Memory)

DVD-Read Only Memory (DVD-ROM) is a standard medium defined by the "DVD -Book" for recording digital data, including Digital Video Movie data.

3.3.19 DVD-RW (DVD Re-recordable)

DVD-RW is a wobble groove based DVD media that is rewritable.

3.3.20 DVD-Video

DVD-Video is a DVD format defined for video applications as specified in the DVD Books.

3.3.21 Disc Key

The Disc Key is a general reference to a cryptographic key that exists for the protection of disc content. The exact meaning is specific to the content protection type.

3.3.22 Disc Manufacturing Information

The Disc Manufacturing Information is recorded in the Control Data Zone and contains information supplied by the disc manufacturer.

3.3.23 ECC Block

The DVD ECC block is 16 data sectors and a layered product error correction code. The HD DVD ECC block is 32 data sectors and a layered product error correction code.

3.3.24 Fragment

Fragment refers to a Logical Track on DVD+R media. See Logical Track.

3.3.25 Identification Data (ID)

The data ID field of a DVD/HD DVD sector is a 4-byte field that contains sector information and a physical sector number.

3.3.26 ID Error Detection (IED)

The IED is an EDC for detecting errors in an ID field on DVD/HD DVD media.

3.3.27 Regional Playback Control (RPC)

RPC limits the playback of DVD-Video content on DVD-ROM discs to specific regions of the world.

3.3.28 Region Code

The region code is used to identify one or more regions of the world for use by RPC.

3.3.29 Recording Management Area (RMA)

RMA is an area for recording RMD. This area starts right after the PCA and it ends at the start of the Lead-in.

3.3.30 Recording Management Data (RMD)

RMD is the data to be stored in RMA/RMZ/RDZ.

3.3.31 Recording management zone (RMZ)

RMZ is the zone for recording RMD. Three kinds of RMZ formats are defined, L-RMZ, B-RMZ and U-RMZ.

3.3.32 RZone

RZone refers to a Logical Track on DVD-R, DVD-RW, and HD DVD-R media. The RZone is a collection of logical blocks with a defined sequence of recording. The RZone is a structure to manage a data appendable point. See the definition for Logical Track.

3.3.33 Title Key

A value used during the encryption/decryption process of user data on DVD media.

3.4 BD Specific Terms

3.4.1 Address In Pre-groove (ADIP)

Address and recording information encoded in the wobble pre-groove on BD-R/RE is named the Address in pre-groove (ADIP).

3.4.2 Blu-ray Disc (BD)

Blu-ray Disc is a family of related optical storage media and drives.

3.4.3 Blu-ray Disc – Recordable (BD-R)

BD-R disc is a BD disc that is write once in increments of 65 536 bytes.

3.4.4 Blu-ray Disc – Rewritable (BD-RE)

BD-RE disc is a BD disc that is Rewritable.

3.4.5 Blu-ray Disc – Read-only Memory (BD-ROM)

A BD-ROM disc is a read-only BD disc.

3.4.6 Cluster

A BD Cluster contains 32 logical sectors. The data of these 32 sectors are interleaved, scrambled, and EDC and ECC symbols are attached.

3.4.7 Disc Definition Structure (DDS)

The DDS is contained within a sector of the DMS. The DDS contains basic format information about the disc, e.g. the physical location of LSN 0, the physical location of the last LSN, and the sizes of the spare areas. On BD-R, the DDS also contains recording mode and TDMA information.

3.4.8 Disc/Defect Management Structure (DMS)

The DMS contains structures that define the disc format and that are necessary for defect management. On BD-R there are two kinds of Disc Management Structures:

1. The Temporary Disc Management Structures (TDMS), recorded in the TDMA Areas as long as the disc has not been closed.
2. Disc Management Structures (DMS), recorded in the DMA Areas when a disc is closed (to preserve all Disc Management information contained in the last Temporary Disc Management Structure).

On BD-RE the Defect Management Structure is written and updated in the DMAs of the inner and outer zones.

3.4.9 Inner Spare Area (ISA0, ISA1)

When defect management is used on BD-R or BD-RE, a spare area may be allocated in the inner radius of each layer. Each of these areas is an Inner Spare Area (ISA). The ISA on layer 0 is referenced as ISA0, while the ISA on layer 1 is referenced as ISA1.

3.4.10 Logical Overwrite (LOW)

LOW is defined in [BD-Ref2] as the physical description of Pseudo-Overwrite. See the Pseudo-Overwrite definition.

3.4.11 Orphan LBA(s)

When a POW is processed, the relocation occurs at the NWA, N of some SRR, T. After the POW process, the NWA is now $N+32*K$, where K is the number of POWed Clusters. LBAs N, N+1, ..., $N+32*K-1$ cannot be used in the next appending write to T. Consequently, these LBAs may be used only by additional POW operations. However, since there is not previous data to replace, these LBAs are Orphans.

3.4.12 Outer Spare Area (OSA0, OSA1)

When defect management is used on BD-R or BD-RE, a spare area may be allocated in the outer radius of each layer. Each of these areas is an Outer Spare Area (OSA). The OSA on layer 0 is referenced as OSA0, while the OSA on layer 1 is referenced as OSA1.

3.4.13 Permanent Information & Control data (PIC) Area

This zone contains general information about the disc. The PIC is embossed on all disc types.

3.4.14 Pseudo-Overwrite (POW)

By using the Linear Replacement algorithm of the BD-R system, overwriting of a recorded Cluster is allowed. POW replacements are taken from the user data area and mapped using DFL. (POW is only defined for SRM formatted BD-R discs.)

3.4.15 Quick Certification

If a FORMAT UNIT command is issued by the Host for a BD-RE disc that was previously formatted, then the requested process is a reformat. Before starting the reformat, the DFL contains a list of Clusters that have been determined to be defective. As a part of the execution of the FORMAT UNIT command that is requesting a reformat, the Drive may certify only Clusters registered in the DFL as defective. Since this process requires significantly less execution time than Full Certification, it is called Quick Certification.

3.4.16 Quick Reformat

If a FORMAT UNIT command is issued by the Host for a BD-RE disc that was previously formatted, then the requested process is a reformat. Before starting the reformat, the DFL contains a list of Clusters that have been determined to be defective.

If a FORMAT UNIT command requests a quick reformat, the Drive shall edit the information for each registered defective Cluster on the disc to a re-usable Cluster status and perform no certification. The Drive shall certify a Cluster that is registered as re-usable only when executing a non-streamed write. Since it is possible to process a reformat faster than with Quick Certification, this process is called Quick Reformat.

3.4.17 Random Recording Mode (RRM)

In the BD-R Random Recording Mode, data **may** be randomly written at every un-recorded Cluster.

3.4.18 Sequential Recording Mode (SRM)

Sequential Recording Mode is defined for BD-R to implement the generalized track/session model defined by MMC for implementation of the Incremental Streaming Writable Feature.

3.4.19 Sequential Recording Range (SRR)

Sequential Recording Range (SRR) is the physical definition of Logical Track for a BD-R in SRM.

3.4.20 Sequential Recording Range Information (SRRi)

Information about the location and status of all SRRs is stored in the Sequential Recording Range Information (SRRi) structures. While the disc is not finalized, the SRRi shall be recorded in the Temporary Disc Management Areas (TDMAs). At finalization, the most recent version of the SRRi is recorded in the Disc Management Area (DMA).

3.4.21 Space Bit Map (SBM)

A Space Bit Map specifies the recording status for a Recording Layer a BD-R disc formatted in Random Recording Mode (RRM).

3.4.22 SRM+POW

A BD-R disc has the SRM+POW status when it has been formatted in Sequential Recording Mode with the POW feature enabled.

3.4.23 SRM-POW

A BD-R disc has the SRM-POW status when it has been formatted in Sequential Recording Mode with the POW feature disabled.

3.4.24 Temporary Disc Management Area (TDMA)

On BD-R, the defect management and recording management information needs to be updated many times during use. For this purpose special areas are available in the Lead-in/Lead-out Area called the Temporary Disc Management Area. Additional TDMAs may be defined within spare areas.

3.4.25 Temporary Disc Management Structure (TDMS)

On BD-R, the Temporary Disc Management Structure (TDMS) is a version of the DMS recorded in a TDMA. The TDMS consists of the following three elements depending on the recording mode.

For sequential recording mode the TDMS consists of:

1. Temporary Disc Definition Structure (TDDS),
2. Temporary Defect List (TDFL),
3. Sequential Recording Range Information (SRRI).

For random recording mode the TDMS consists of:

1. Temporary Disc Definition Structure (TDDS),
2. Temporary Defect List (TDFL),
3. Space Bit Maps (SBM).

3.5 Abbreviations and Acronyms

AACS	Advanced Access Content System
ADIP	Address In Pre-groove
AGID	Authentication Grant ID
ASC	Additional Sense Code
ASCQ	Additional Sense Code Qualifier
ASF	Authentication Success Flag
ATA	AT Attachment
ATAPI	AT Attachment Packet Interface
ATIP	Absolute Time In Pre-groove
BD	Blu-ray Disc
BD-R	Blu-ray Disc Recordable
BD-RE	Blu-ray Disc Rewritable
BD-ROM	Blu-ray Disc Read-only Memory
BCA	Burst Cutting Area
BCD	Binary Coded Decimal
BG	Background
CDB	Command Descriptor Block
CD	Compact Disc
CDZ	Control Data Zone (on DVD media)
CD-DA	CD – Digital Audio
CD-R	CD – Recordable
CD-ROM	CD – Read Only Memory
CD-R/RW	a CD-R, a CD-RW, or both
CD-RW	CD ReWritable
CPPM	Content Protection for Prerecorded Media
CPRM	Content Protection for Recordable Media
CIRC	Cross Interleaved Reed-Solomon Code
CSS	Content Scrambling System
DA	Data Area
DBI	Defective Block Information
DVD	Digital Versatile Disc
DVD-R	DVD-Recordable
DVD-R DL	DVD-R Dual Layer
DVD-RW	DVD-Re-recordable
DVD-R/-RW	DVD-R, DVD-RW or both
DVD-RAM	DVD-Random Access Memory
DVD-ROM	DVD-Read Only Memory
DVD+R	DVD+Recordable
DVD+R DL	DVD+R Double Layer
DVD+RW	DVD+ReWritable
DVD+RW DL	DVD+RW Dual Layer
DVD+R/+RW	DVD+R, DVD+RW or both
DZ	Data Zone
EAN	European Article Number

ECC	Error Correction Code
EDC	Error Detection Code
HD DVD	High Definition DVD
HD DVD-R	HD DVD Recordable
HD DVD-ROM	HD DVD Read-Only-Memory
HD DVD-RAM	HD DVD Rewritable
ID	Identification Data
IED	ID Error Detection
ISAx	Inner Spare Area, layer x
L-EC	Layered Error Correction
LBA	Logical Block Address
LSB	Least Significant Bit
LUN	Drive Number
MCN	Media Catalog Number
MDT	Main Defect Table
MIP	Main Information Packet
MM	Multi-Media
MRW	Mount Rainier reWritable
MSB	Most Significant Bit
MSF	Minute/Second/Frame
OPC	Optimum Power Calibration
OSAx	Outer Spare Area, layer x
OTP	Opposite Track Path
PIC	Permanent Information & Control
PTP	Parallel Track Path
PMA	Program Memory Area
PSN	Physical Number
RPC	Region Playback Control
SIP	Secondary Information Packet
SK	Sense Key
TOC	Table of Contents
TAO	Track at Once
TDB	Track Descriptor Block
TSR	Timely, Safe Recording
UDF	Universal Disk Format
UPC	Uniform Product Code

3.6 Keywords

3.6.1 expected

A keyword used to describe the behavior of the hardware or software in the design models assumed by this standard. Other hardware and software design models may also be implemented.

3.6.2 legacy

Bits, bytes, fields, and code values that have been defined in previous standards but have been replaced by preferred methods in this standard may be considered obsolete. If the method has a long-standing history of use, then obsoleting the method may be detrimental to many users and should then be defined as legacy rather than obsolete.

Hosts should not use legacy commands or mode pages.

Devices conforming to this standard should not support commands or mode pages defined as legacy in previous standards.

Legacy methods do not appear in the main body of this or subsequent standards.

Legacy methods that are considered important are specified in an informative annex of this standard. Devices implementing legacy commands or mode pages shall implement them according to the most recent and appropriate standard that carries a definition.

3.6.3 may

May indicates flexibility of choice with no implied preference (equivalent to “may or may not”).

3.6.4 may not

May not indicates flexibility of choice with no implied preference (equivalent to “may or may not”).

3.6.5 shall

“Shall” is a keyword indicating a mandatory requirement. Designers are required to implement all such mandatory requirements to ensure interoperability with other standard conforming products.

3.6.6 should

“Should” is a keyword indicating flexibility of choice with a strongly preferred alternative. “Should” is equivalent to the phrase “it is recommended.”

3.6.7 obsolete

A keyword used to describe bits, bytes, fields, and code values that have been defined in prior standards but has been removed from this standard.

Devices conforming to this standard should not support commands or mode pages defined as obsolete in previous standards. Devices implementing obsolete commands or mode pages shall implement them according to the most recent and appropriate standard that carries a definition.

If obsolete bits, bytes, fields, or code values are not implemented, their value shall be reserved.

3.6.8 mandatory

“Mandatory” is a keyword indicating items required to be implemented as defined by this standard.

3.6.9 optional

“Optional” is a keyword that describes Features that is not required for compliance to this standard. However, if any optional Feature defined is implemented, it shall be implemented as defined by this standard.

3.6.10 reserved

“Reserved” is a keyword referring to bits, bytes, words, fields and code values that are set aside for future standardization. A reserved bit, byte, word or field shall be set to zero, or in accordance with a future extension to this standard. Recipients are not required to check reserved bits, bytes, words or fields for zero values. Receipt of reserved code values in defined fields shall be reported as error.

3.7 Conventions

Various conventions are used through out this standard and are identified in this sub-clause.

Certain words and terms used in this standard have a specific meaning beyond the normal English meaning. These words and terms are defined either in 3.1 or in the text where they first appear. Names of commands, statuses, sense keys, and additional sense codes are in all uppercase (e.g., REQUEST SENSE). Lowercase is used for words having the normal English meaning.

If there is more than one CDB length for a particular command (e.g., MODE SENSE(6) and MODE SENSE(10)) and the name of the command is used in a sentence without any CDB length descriptor (e.g., MODE SENSE), then the condition specified in the sentence applies to all CDB lengths for that command.

The names of fields are in uppercase (e.g., ALLOCATION LENGTH). Normal case is used when the contents of a field are being discussed. Fields containing only one bit are usually referred to as the name bit instead of the name field.

The decimal sign is a comma (,) on the line between the whole and fractional numbers. Spaces are used to separate groups of three digits on either side of the decimal sign. A value less than 1 is written with a zero preceding the decimal sign. Numbers that are not immediately followed by lowercase "b," "h," or "bcd" are decimal values.

Numbers immediately followed by lowercase "b" (xxb) are binary values.

Numbers immediately followed by lowercase "h" (xxh) are hexadecimal values.

Numbers immediately followed by lowercase "bcd" (xxbcd) are binary coded decimal values.

Values indicated by a lower case "k" have a base value of 1 000 units.

Values indicated by an uppercase "K" have a base value of 1 024 units.

Values indicated by a lower case "m" have a base value of 1 000 000 units.

Values indicated by an uppercase "M" have a base value of 1 048 576 units.

Values indicated by a lower case "g" have a base value of 1 000 000 000 units.

Values indicated by an uppercase "G" have a base value of 1 073 741 824 units.

When the value of the bit or field is not relevant, x or xx appears in place of the specific value.

Lists sequenced by letters (e.g., a-red, b-blue, c-green) show no priority relationship between the listed items.

Numbered lists (e.g., 1-red, 2-blue, 3-green) show a priority ordering between the listed items. If a conflict arises between text, tables, or figures, the order of precedence to resolve the conflicts is text; then tables; and finally figures. Not all tables or figures are fully described in the text. Tables show data format and values.

Notes do not constitute any requirements for implementers.

Recommended error code tables defined within each command sub-clause uses the following:

Errors shown in mixed case indicate all errors, in that class, are valid.

Errors shown in uppercase refer to the identified specific error condition.

The string SK/ASC/ASCQ refers to the low order 4 bits of byte 2 and bytes 12, and 13 in the referenced Drive's sense data. SK/ASC/ASCQ is used interchangeably with the names associated with the coded values in those sense bytes. In this standard, the numeric SK value may be replaced by its equivalent text. The numeric values of ASC and ASCQ are typically replaced by a single text phrase. e.g., when the numeric values for SK/ASC/ASCQ are 03h/11h/05h, the text replacements are MEDIUM ERROR/L-EC UNCORRECTABLE ERROR.

If a reference is made to a document or standard, the document or standard name appears in italics.

Formulae appear in italics.

3.8 Bit and byte ordering

This sub-clause describes the representation of fields in a table that defines the format of a SCSI structure (e.g., the format of a CDB).

If a field consists of more than one bit and contains a single value (e.g., a number), the least significant bit (LSB) is shown on the right and the most significant bit (MSB) is shown on the left (e.g., in a byte, bit 7 is the MSB and is shown on the left; and bit 0 is the LSB and is shown on the right). The MSB and LSB are not labeled if the field consists of 8 or fewer bits.

If a field consists of more than one byte and contains a single value, the byte containing the MSB is stored at the lowest address and the byte containing the LSB is stored at the highest address (i.e., big-endian byte ordering). The MSB and LSB are labeled.

If a field consists of more than one byte and contains multiple fields each with their own values (e.g., a descriptor), there is no MSB and LSB of the field itself and thus there are no MSB and LSB labels. Each individual field has an MSB and LSB that are labeled as appropriate in the table (if any) that describes the format of the sub-structure having multiple fields.

If a field contains a text string (e.g., [ASCII]), the MSB label is the MSB of the first character and the LSB label is the LSB of the last character.

When required for clarity, multiple byte fields may be represented with only two rows in a table. This condition is represented by values in the byte number column not increasing by one in each subsequent table row, thus indicating the presence of additional bytes.

3.9 Notation conventions

When this standard requires one or more bytes to contain specific encoded character, the specific characters are enclosed in double quotation marks. The double quotation marks identify the start and end of the characters that are required to be encoded but are not themselves to be encoded. The characters that are to be encoded are shown in exactly the case that is to be encoded.

The encoded characters and the double quotation marks that enclose them are preceded by text that specifies the character encoding methodology and the number of characters required to be encoded.

Using the notation described in this sub-clause, stating that eleven [ASCII] characters "SCSI device" are to be encoded would be the same writing out the following sequence of byte values: 53h 43h 53h 49h 20h 64h 65h 76h 69h 63h 65h.

This page is intentionally blank

4 Models

4.1 General

4.1.1 Overview

A multi-media (MM) device is defined primarily by the media it supports: CD, DVD, HD DVD, BD and each sub-case: read-only, recordable, rewritable. Additionally, the devices are defined by specific capabilities associated with each media type.

Each MM disc type is removable. MM devices may also carry additional capabilities such as integrated media changers.

4.1.2 Common Physical Media Structure

4.1.2.1 The Disc

Physically, each MM disc has a typical thickness of 1,2 mm and diameters as shown in Figure 1. The dimensions are not precise and are shown for descriptive purposes.

Data is stored in a layer within the disc that has known reflective properties. There may be one or two such layers. Recording is typically linear along the spiral. The direction of recording on the first layer (Layer 0) is from inner radius to outer radius. If a second layer is present (Layer 1), and its spiral runs parallel to the spiral of the first layer, then the tracking of the layer pair is called parallel-track-path (PTP). If a second layer is present (Layer 1), and its spiral runs opposite to the spiral of the first layer (i.e. from outer radius to inner radius), then the tracking of the layer pair is called opposite-track-path (OTP).

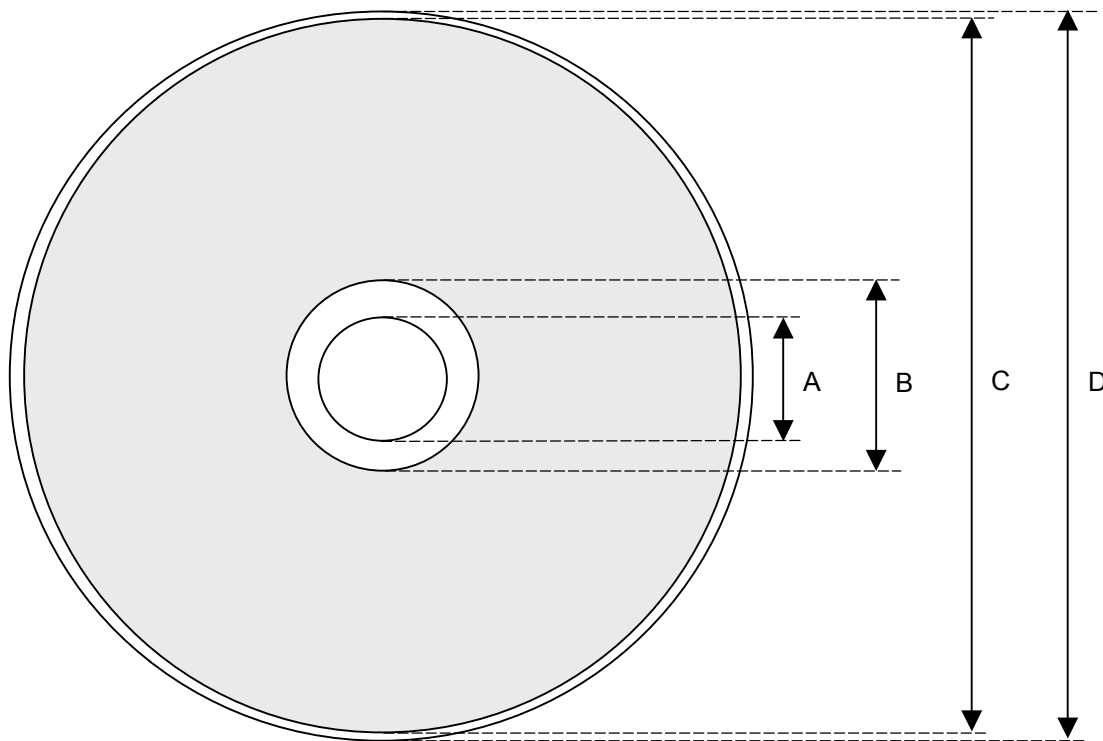

A - Center Hole	Nominally 15mm
B - Start of Spiral	Varies from 44mm to 50mm
C - End of Spiral	Varies from 76-77mm or 116-117mm
D - Diameter of Disc	Nominally 80mm or 120mm

Figure 1 — Typical MM Disc

Each spiral contains 3 distinct zones in its Information Zone (Figure 2): Inner, Data, and Outer.

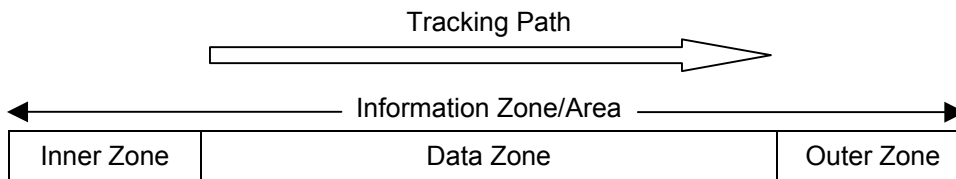

Figure 2 — General Spiral Structure

The Inner Zone is a region that separates the physical beginning of the recorded/recordable region from the start of the Data Zone.

The Data Zone is reserved for user data purposes.

The Outer Zone is a region that separates the end of the Data Zone from the physical end of the recorded/recordable area.

4.1.2.2 Single Layer Structure

On single layer discs, the Lead-in is a contiguous region of the Inner Zone adjacent to the Data Zone. On some discs, the Lead-in is the Inner Zone. The Lead-in may contain information that relates to organization of the recorded space.

On single layer discs, the Lead-out is a contiguous region of the Outer Zone adjacent to the Data Zone. On some discs, the Lead-out is the Outer Zone. The Lead-out region may contain information that relates to organization of the recorded space.

Figure 3 shows the appropriate relationships.

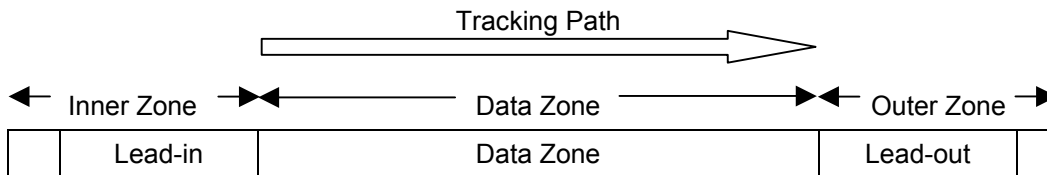

Figure 3 — General Single Layer Structure

4.1.2.3 Dual Layer PTP Structure

A dual layer disc with PTP spirals defines each layer as two independent Information Zones, each with single layer structure as shown in Figure 4.

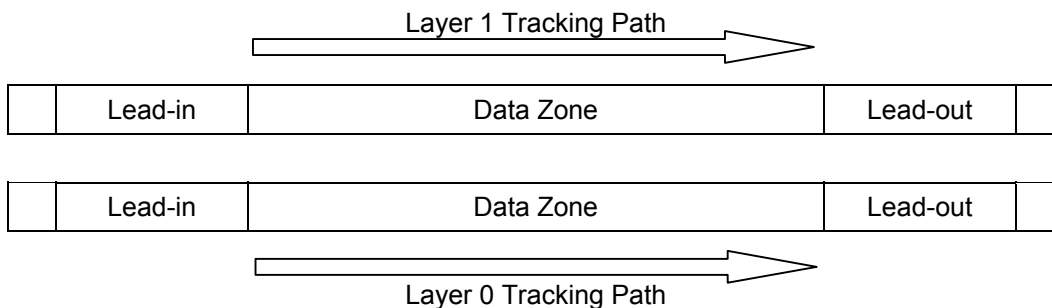

Figure 4 — General Dual Layer PTP Structure

Each spiral has a lead-in in its inner zone and a lead-out in its outer zone. Logically, the data of both spirals is organized as a single volume.

4.1.2.4 Dual Layer OTP Structure

On dual layer OTP discs, the Lead-in is a contiguous region of the Layer 0 Inner Zone adjacent to the Layer 0 Data Zone. On some discs, the Lead-in is the Layer 0 Inner Zone. The Lead-in may contain information that relates to organization of the recorded space.

The Outer Zone on Layer 0 is a region reserved for layer transitions called a Middle Area. Similarly, the Outer Zone on Layer 1 is a region reserved for layer transitions called a Middle Area.

The Lead-out is a contiguous region of the layer 1 Inner Zone adjacent to the layer 1 Data Zone. On some discs, the Lead-out is the layer 1 Inner Zone. The Lead-out region may contain information that relates to organization of the recorded space.

Figure 5 shows the appropriate relationships.

Logically, the data of both spirals is organized as a single volume.

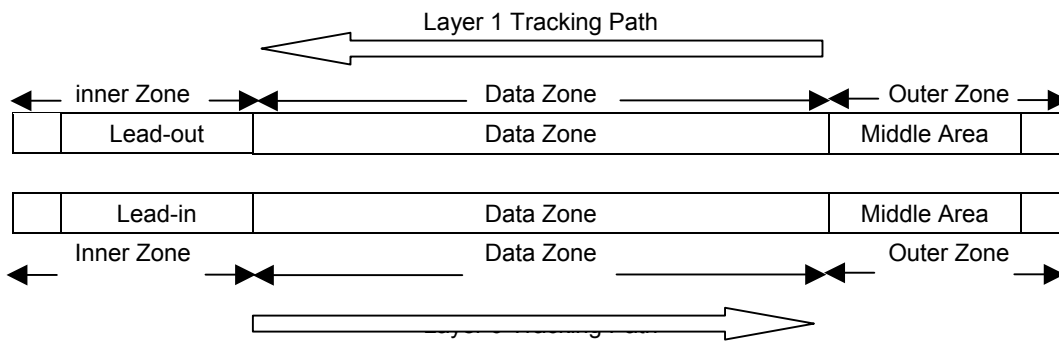

Figure 5 — General Dual Layer OTP Structure

4.1.2.5 Data Structure in a Spiral

4.1.2.5.1 Modulation Coding

When a laser is focused on a recorded layer, the returned light changes based upon the state of the recorded layer at the focal point. Recording changes some physical characteristic of the layer, such as changing the reflectivity. An unrecorded area is detected as a "space", while a recorded area is detected as a "mark".

Data is stored on the spiral in a binary representation where a "mark" is one of the binary states and a "space" is the other binary state. A bit thus recorded is called a channel bit. At high read-out speeds, bytes of data to be stored are first encoded to ensure that the number of sequentially recorded marks or sequentially unrecorded spaces is neither too long nor too short for optimal detection mechanisms. The coding used for that purpose is a modulation code.

4.1.2.5.2 Error Detection and Error Correction Coding

MM user data is created as a group of bytes that are to be stored as a single recordable unit. These recordable units of data have error correction coding included in order to maximize data reliability. These are typically byte based Reed-Solomon block codes that are typically layered similar to product coding. The precise mechanisms are media type dependent.

In order to maximize the integrity of the stored data unit, error detection codes may be included prior to appending ECC symbols as shown in Figure 6.

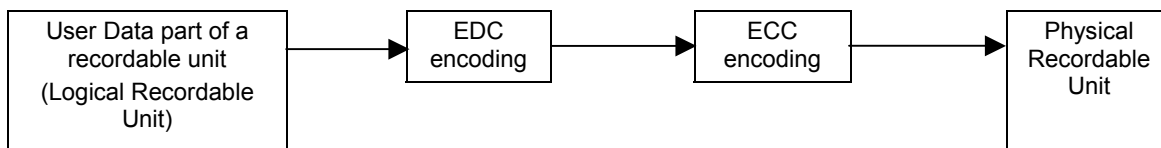

Figure 6 — Content of a Recordable Unit

4.1.3 Logical Presentation of the Media

4.1.3.1 Logical Blocks

Multi-media devices may store blocks of user data for later retrieval. The user data block size for MM devices and media is 2 048 bytes (although there are some exceptions for CD). Each block of data is stored at a unique Logical Block Address (LBA).

Blocks of data are stored on the medium along with additional information that the Drive uses to manage storage and retrieval. The format of the additional information is unique and is hidden from the Host during normal reading or writing. This additional information is often used to identify the physical location of a block of data, the logical address of the logical block(s), and to provide protection against the loss of the user data. A sector is the logical block data plus the additional information that is uniquely associated with it.

When the media is writable, a Host issues WRITE commands to store the blocks of data (write operations) and READ commands to retrieve the blocks of data (read operations). Other commands issued by the Host may also cause write and read operations to occur. A write operation causes one or more blocks of data to be written on the medium. A read operation causes one or more blocks of data to be read from the medium. A verify operation confirms that one or more blocks of data were correctly written and may be read without error from the medium.

The LBA of the first logical block is zero. The LBA of the last logical block is $N - 1$, where N is the number of logical blocks available on the medium. Each integer beginning with zero and stopping at $N-1$ is an LBA and is associated with a unique block. A READ CAPACITY command may be issued to determine the value of $N - 1$. If a command is issued that requests access to a logical block address not within the capacity of the medium, the command shall be terminated with CHECK CONDITION status and the SK/ASC/ASCQ values shall be set to ILLEGAL REQUEST/LOGICAL BLOCK ADDRESS OUT OF RANGE.

The number of bytes of data contained in a logical block is the block length. Each logical block has a block length associated with it. Block storage Drives defined in [SBC] use the Block Descriptor structure in mode data for the definition of block size. Multi-media Drives do not support Block Descriptors. The Block Descriptor Length field in the Mode Data Header shall be set to zero. When accessing the media with READ (10), READ (12), VERIFY (10), or VERIFY (12), the block length shall be 2 048 bytes. Block size is self defined by READ CD and READ CD MSF commands. When the media is CD-R/-RW and the media is accessed with WRITE (10) or WRITE (12), block length is determined by the Write Parameters mode page.

The physical location of a logical block on the medium is not required to have a specific relationship to the location of any other logical block. The time to access the logical block at address X and then the logical block at address $X+1$ may not be less than the time to access X and then any other block on the medium.

4.1.3.2 Logical Sub-Divisions of Media

4.1.3.2.1 General

There are two general ways to access any disc: Random and Sequential.

When the disc is accessed in a random way for reading, each read command may address any area of the LBA space. When the disc is accessed in a random way for writing, each write command may address any area of the LBA space. When the drive/media combination permits the random reading and random writing of logical blocks, the media is represented only as a single addressable LBA space.

All MM drive/media combinations permit random reading within the recorded LBA space. Many MM drive/media combinations do not permit random writing within the recorded LBA space. This is always true for write-once media, because once a recordable unit is written, it cannot be recorded again. Random writing is also not permitted on rewritable media such as CD-RW. Since the data from each pair of adjacent CD-RW sectors are interleaved, it is not possible to replace a single sector. It is possible to continue recording after a "linking loss". For CD, the linking loss is 7 sectors and on DVD-R, the linking loss is either 1 or 16 sectors. The capacity losses associated with linking are negligible when the occurrence rate is very low.

When sequential recording is required, some MM media types support a logical subdivision of the address space. These sub-divisions typically require some LBA space for overhead - for management and linking loss. The management areas are not available for user data and reading may not be permitted.

4.1.3.2.2 Logical Tracks

4.1.3.2.2.1 Overview

A Logical Track is a non-zero number of sectors with a well defined usage sequence. In most cases, the Logical Track must also be an integral number of media specific writable units. The name of the physical representation of a Logical Track varies according to MM disc type as shown in Table 1.

Table 1 — Logical Track Naming

MM Disc Type	Media Specific Name
CD-ROM/-R/-RW	Track
DVD-R/-RW, DL DVD-R, HD DVD-R	RZone
DVD+R, DL DVD+R	Fragment
BD-R	SRR

In each case, the start address of the area may be discovered independently to facilitate faster access. Because each of these sub-divisions has similar characteristics to the others, this standard refers to the generic variant of this logical sub-division as a Logical Track.

A Logical Track typically loses a non-zero, format dependent number of LBAs at its beginning and at its end (e.g. linking loss). The Host may discover information about Logical Tracks by using the READ TOC/PMA/ATIP and READ TRACK INFORMATION commands.

A Logical Track may be written only in a pre-defined recording sequence.

Each MM media type has at least one Logical Track. The maximum number of Logical Tracks permitted is media type dependent. Each MM media type (Table 1) that supports multiple Logical Tracks may be structured to have exactly one Logical Track. Each of the other MM media types (i.e. those not listed in Table 1) is always viewed to have exactly one Logical Track consisting of the LBA space of the disc.

4.1.3.2.2 Properties of Logical Tracks

Each Logical Track has certain properties regardless of MM disc type as shown in Table 2.

Table 2 — Properties of Logical Tracks

Logical Track Property	Meaning
Number	Each MM media type has at least one Logical Track. The maximum number of Logical Tracks permitted is media type dependent. Logical tracks are integrally numbered beginning with a number no smaller than 1.
Start Address	The LBA of the first used block in the Logical Track.
Size	The number of user blocks in the Logical Track.
Blank Space	The number of logical blocks available to be written in the Logical Track.
Next Writable Address	Since Logical Tracks must be recorded in a pre-defined sequence, the Next Writable Address (NWA) is the next LBA that the Host is permitted to write. When Blank Space = 0, NWA cannot be valid.
Open Logical Track	When Blank Space is not zero, the Logical Track is open. If the NWA is valid, the Logical Track is open.
Closed Logical Track	A Logical Track is closed when it is not open.
Reserved Track	A Logical Track is reserved, if its start address and size are fixed.
Invisible/Incomplete Logical Track	If the last Logical Track in the collection of all Logical Tracks is open and not reserved, then it is considered incomplete. The incomplete Logical Track often exists by default. That is, there is no written record of its existence on the disc. Consequently, the incomplete Logical Track is also known as the invisible Logical Track. It is usually permitted to create a new reserved Logical Track from the beginning of the incomplete Logical Track.

4.1.3.3 Sessions

A Session is a collection of one or more Logical Tracks with consecutive track numbers. The Session provides Host applications with a method of incrementally appending new data to a partially recorded MM disc.

Sessions are numbered integrally beginning with 1.

The user data area for any session is sub-divided into Logical Tracks. A session shall have at least one Logical Track. The maximum number of Logical Tracks in a session is MM disc type dependent. See Figure 7.

Information about the MM disc structure is given by the READ DISC INFORMATION command. Information about the session and Logical Track structure is discovered in data returned by the READ TRACK INFORMATION command.

The detailed session structure of a MM disc is disc type dependent. See the media specific model sub-clause.

The general view of disc, session and Logical Track decomposition is shown in Figure 7.

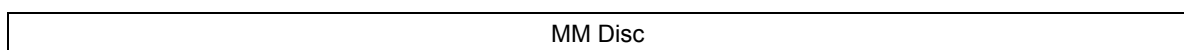

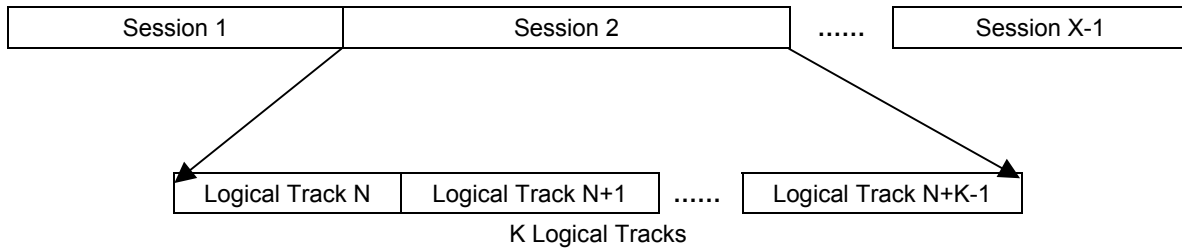

Figure 7 — Disc, Session and Logical Track Decomposition

4.1.4 Data cache

Many Drives implement cache memory. A cache memory is usually an area of temporary storage in the Drive that has fast access time and is used to enhance performance. It exists separately from the blocks of data stored and is normally not directly addressable by the Host. Use of cache memory for write or read operations typically reduces the access time to a logical block and may increase the overall data throughput.

During read operations, the Drive uses the cache memory to store blocks of data that the Host may request at some future time. The algorithm used to manage the cache memory is not part of this standard. However, parameters are provided to advise the Drive about future requests, or to restrict the use of cache memory for a particular request.

Sometimes the Host may request that the blocks of data read from the medium instead of from the cache memory. The force unit access (FUA) bit in the CDBs of some commands is used to indicate that the Drive shall access the physical medium. For a write operation, setting FUA to one causes the Drive to complete the data write to the physical medium before completing the command. For a read operation, setting FUA to one causes the logical blocks to be retrieved from the physical medium.

The Drive may implement commands that allow the Host to control other behavior of the cache memory:

- The MODE SENSE (10) Command defines a page for the control of cache behavior and handles certain basic elements of cache replacement algorithms.
- The SYNCHRONIZE CACHE Command is used by the Host to guarantee that data in the cache has been moved to the media.

Specific cache control mechanisms are described in [SBC-2].

4.1.5 Resets

4.1.5.1 Reset Types

Within this standard there are three resets identified. These resets are named:

- a) Power-On Reset
- b) Hard Reset
- c) Device Reset

These resets are used differently in each physical interface referenced. For more information on the use in specific physical interfaces, see the appropriate Annex on implementation notes.

4.1.5.2 Power-On Reset

When power is applied, the Drive processes a series of electrical circuitry diagnostics, resets Drive specific parameters (mode pages) to default values, and if media is present, may spin up and make the Drive ready for use. In addition, power management and content management are reset to their default states.

4.1.5.3 Hard Reset

For each physical interface the detection of Hard Reset is different. The behavior of the Drive when Hard Reset is received is the same as for Power On Reset.

Hard Reset is used to reset Drives or even a whole interface bus, not individual Drives.

When the Drive is connected via ATAPI, SRST action may be deferred until critical activities have completed. Afterward, SRST is treated as a Hard Reset. See [ATA-7].

4.1.5.4 Device Reset

For each physical interface the detection of Device Reset is different. The Device Reset is used to bring a non-responding Drive into an operable state. Device Reset is different from Power On or Hard Reset. With the Device Reset the parameters being used by the Drive are not set to the defaults. In some cases this may not be possible and the Drive may need to reset to the default conditions. If a reset to default conditions occurs as a result of a Device Reset, a Unit attention condition and Power Management Event Notification should be generated. Drive should:

- 1) Reset Host interface circuitry.
- 2) Perform hardware initialization and device-internal diagnostics only if necessary.
- 3) Do not revert to the default conditions or delete any information about the currently mounted medium.
- 4) Do not change current Power State.
- 5) Do not change Persistent Prevent state.
- 6) Reset content management to the default state.

4.1.6 Error reporting

4.1.6.1 Unit Attention Conditions

If a Host issues a command other than GET CONFIGURATION, GET EVENT STATUS NOTIFICATION, INQUIRY or REQUEST SENSE while a unit attention condition exists for that Host, the Drive shall not perform the command and shall report CHECK CONDITION status unless a higher priority status as defined by the Drive is also pending.

4.1.6.2 Drive Busy Conditions

A Drive may become Busy, thereby limiting the number of commands that may be processed to completion.

While a Drive is Busy, it shall accept and process REQUEST SENSE, INQUIRY, GET CONFIGURATION, GET EVENT STATUS NOTIFICATION, and TEST UNIT READY. However, the Drive may not be able to process some commands and shall respond with CHECK CONDITION status with sense key set to NOT READY, ASC set to DRIVE NOT READY, and ASCQ set to OPERATION IN PROGRESS, LONG WRITE IN PROGRESS, or FORMAT IN PROGRESS.

Commands that have an immediate bit set to one in their CDBs may cause a Drive Busy condition.

A Drive may become Busy under the conditions described above, however, the Drive is not required to become Busy. e.g., if the Host sends a CLOSE TRACK SESSION command with immediate bit set to one to close a

track and the track is already closed, the Drive may terminate the command with GOOD status and never enter the Drive Busy condition.

During cached recording when the write buffer has become full, a Drive may respond to a WRITE command with CHECK CONDITION status and sense bytes SK/ASC/ASCQ set to NOT READY/DRIVE NOT READY/LONG WRITE IN PROGRESS. This particular case is not a Drive Busy condition.

When a Drive that was not busy, becomes busy, a Device Busy Event shall be generated indicating that the Busy State has changed and the Busy State is Busy.

When a Drive that was busy, becomes not busy, a Device Busy Event shall be generated indicating that the Busy State has changed and the Busy State is Not Busy.

Device Busy Event reporting is described in 6.7.2.8.

Table 3 shows examples of error reporting during a Drive Busy condition.

Table 3 — Busy Condition Examples

Situation	SK Value	ASC Value	ASCQ Value
BLANK command with CDB Immediate bit set to one is in progress	NOT READY	DRIVE NOT READY	OPERATION IN PROGRESS or LONG WRITE IN PROGRESS
CLOSE TRACK SESSION command with CDB Immediate bit set to one is in progress	NOT READY	DRIVE NOT READY	OPERATION IN PROGRESS or LONG WRITE IN PROGRESS
FORMAT UNIT command with parameter list Immediate bit set to one is in progress	NOT READY	DRIVE NOT READY	FORMAT IN PROGRESS
Last WRITE command in a DAO recording. This is equivalent to sending a SYNCHRONIZE CACHE command with the immediate bit set to one.	NOT READY	DRIVE NOT READY	LONG WRITE IN PROGRESS

4.1.6.3 Unable to Write Errors

Drives that possess no feature indicating write capability shall respond to any command that requires writing with CHECK CONDITION status and set sense bytes SK/ASC/ASCQ to ILLEGAL REQUEST/INVALID COMMAND OPERATION CODE.

Drives that possess one or more write features may still be unable to write. If the Host sends a command that requires writing to the currently mounted medium, but some condition exists such that the Drive is not capable of writing to the media, the command shall be terminated with CHECK CONDITION status and sense bytes SK/ASC/ASCQ shall be set according to Table 4.

Table 4 — SK/ASC/ASCQ Specification for Unable to Write Situations

Error Situation	SK/ASC/ASCQ
Medium is read-only.	ILLEGAL REQUEST/CANNOT WRITE MEDIUM — INCOMPATIBLE FORMAT
Medium is write-once. Host is attempting overwrite.	ILLEGAL REQUEST/INVALID FIELD IN CDB, or ILLEGAL REQUEST/INVALID ADDRESS FOR WRITE, or Sense key is set to BLANK CHECK and ASC /ASCQ is not specified in this standard.
Medium is write protected.	DATA PROTECT/WRITE PROTECTED – The ASCQ shall be set as described in Table 80.
Drive is not capable of writing to the specific physical media/media format. e.g., writable DVD medium in a CD recorder with no DVD capability.	NOT READY/MEDIUM NOT PRESENT (device is unable to detect the presence of media), or NOT READY/CANNOT WRITE MEDIUM – INCOMPATIBLE MEDIUM (device detects media presence, but is unable to identify media), or ILLEGAL REQUEST/CANNOT WRITE MEDIUM – INCOMPATIBLE MEDIUM (device only has read capability)
The Drive is able to write some versions of the currently mounted media type, but not the version of currently mounted media.	ILLEGAL REQUEST/CANNOT WRITE MEDIUM – INCOMPATIBLE FORMAT, or ILLEGAL REQUEST/CANNOT WRITE MEDIUM – UNSUPPORTED MEDIUM VERSION

4.1.6.4 Deferred Errors

Some MM Drives may support commands that return GOOD status prior to actual Command Processing. These commands are associated with the use of the immediate bit or some forms of write caching. Multi-media Drives that implement these features shall implement deferred error reporting. See [SPC-3] for definition and handling.

4.1.7 Removable medium

A disc has an attribute of either being mounted or unmounted on a suitable transport mechanism. A disc is mounted when the Drive is capable of performing read operations to the medium. A mounted disc may not be accessible by a Host, if another Host has reserved it. A disc is unmounted at any other time (e.g. during loading, unloading, or storage). A Host may check the mounted status by issuing a TEST UNIT READY command.

The REMOVABLE MEDIUM Feature provides the Host with commands to load or eject media and to prevent the removal of any media.

The PREVENT ALLOW MEDIUM REMOVAL command allows a Host to restrict the de-mounting of the disc. This is useful in maintaining system integrity. If the Drive implements cache memory, it shall ensure that all logical blocks of the medium contain the most recent data prior to permitting de-mounting of the disc. If the Host issues a START STOP UNIT command to eject the disc, and is prevented from de-mounting by the PREVENT ALLOW MEDIUM REMOVAL command, the START/STOP UNIT command is rejected by the Drive.

When the Persistent Prevent state is entered, the currently mounted media shall remain locked in the Drive, until the Host issues an eject request, or a Power-on Reset or Hard reset condition occurs. The Persistent Prevent state shall be maintained after the eject request. New media that is inserted into the Drive shall be locked in the Drive once the NEW MEDIA event is reported. Prior to reporting the NEW MEDIA event, the Drive may eject media without an explicit eject command from the Host. This allows the user to remove incorrectly inserted media without having to wait for Host intervention.

While in the Persistent prevent state, the Drive shall generate Events upon receipt of a User Eject request. The Drive shall not eject the media on receipt of these requests if the Drive has already reported a NEW MEDIA event for this media. If a Drive allows an eject between generating and reporting the NEW MEDIA event, the Drive shall remove the NEW MEDIA event(s) from the Event queue. When the Host receives the Eject Request

and determines that it is safe to eject the medium, an eject command (START STOP UNIT command with LoEj bit set to one) should be issued. At that time the Drive **may** eject the medium. The Persistent Prevent State is retained.

The Drive only generates GET EVENT STATUS NOTIFICATION (EJECT REQUEST) events after reporting a GET EVENT STATUS NOTIFICATION (NEW MEDIA) event, and prior to reporting a GET EVENT STATUS NOTIFICATION (MEDIA REMOVAL) event for the given media.

To maintain compatibility with existing BIOS implementations and operating systems, the Drive shall default to Persistent Prevent disabled. When the Host enables the support using the PREVENT ALLOW MEDIUM REMOVAL command, the Drive shall respond as described in this standard. When the Host disables the Persistent Prevent capability, the Drive defaults to normal operating modes. A Power-on or Hard reset causes the Drive to return to the default Persistent Prevent state.

If the Drive is unable to maintain media status information across a Hard reset or power cycle, the Drive shall generate a NEW MEDIA event after the currently mounted media is made ready.

Commands shall be processed exactly the same as if Persistent Prevent was not enabled. For compatibility reasons, a unit attention condition is generated. Execution of the GET EVENT STATUS NOTIFICATION command does not include terminating with CHECK CONDITION status when a unit attention condition is pending. e.g., if the user inserts a new medium and the Drive is accessed with a command, a unit attention condition shall be generated, but the Drive shall also report the NEW MEDIA Event with the next available GET EVENT STATUS NOTIFICATION (Media Status) command.

4.1.8 Drive Ready/Not Ready Conditions

The ready condition occurs after a disc is inserted and the Drive has performed its initialization tasks. A not ready condition shall occur only for one or more of the following reasons:

- a) There is no medium mounted.
- b) The Drive is unable to load or unload the medium.
- c) The Drive is unable to recover critical information about the logical structure of the spiral(s).
- d) As otherwise described in the command operation.

Table 5 and Table 6 define the Not Ready Error reporting for commands. Some commands may report not ready under some conditions and ready under other conditions. The tables represent predominant situations.

Table 5 — Commands that should report the Not Ready Condition

Command Name	Op Code	Command Name	Op Code
BLANK	A1h	REPORT KEY	A4h
CLOSE TRACK/SESSION	5Bh	RESERVE TRACK	53h
FORMAT UNIT	04h	REZERO UNIT	01h
LOAD/UNLOAD MEDIUM	A6h	SEEK	2Bh
PREFETCH	34h	SEND DISC STRUCTURE	BFh
READ	28h, A8	SEND OPC INFORMATION	54h
READ CAPACITY	25h	SEND KEY	A3h
READ CD	BEh	SET READ AHEAD	A7h
READ CD MSF	B9h	SET STREAMING	B6h
READ DISC INFORMATION	51h	START STOP UNIT	1Bh
READ DISC STRUCTURE	ADh	SYNCHRONIZE CACHE	35h
READ SUB-CHANNEL	42h	TEST UNIT READY	00h
READ TOC/PMA/ATIP	43h	VERIFY	2Fh, Afh
READ TRACK INFORMATION	52h	WRITE	2Ah,AAh
REPAIR TRACK	58h	WRITE AND VERIFY	2Eh

Table 6 — Commands that should not report the Not Ready Condition

Command Name	Op Code	Command Name	Op Code
GET CONFIGURATION	46h	READ BUFFER CAPACITY	5Ch
GET EVENT STATUS NOTIFICATION	4Ah	READ FORMAT CAPACITIES	23h
GET PERFORMANCE	ACh	RECEIVE DIAGNOSTIC RESULTS	1Ch
INQUIRY	12h	RELEASE	17h, 57h
LOCK/UNLOCK CACHE	36h	REPORT LUNS	A0h
LOG SELECT/SENSE	4Ch, 4Dh	REQUEST SENSE	03h
MECHANISM STATUS	BDh	RESERVE	16h, 56h
MODE SELECT	55h, 15h	SEND CUE SHEET	5Dh
MODE SENSE	5Ah, 1Ah	SEND DIAGNOSTICS	1Dh
PREVENT ALLOW MEDIUM REMOVAL	1Eh	SET CD SPEED	BBh
READ BUFFER	3Ch	WRITE BUFFER	3Bh

4.1.9 Timeouts

4.1.9.1 General

Many Host implementations associate a time limit for execution of each command. If a command has not reported status, but the Host's time limit has expired, the Host has few options in forcing termination of the command. Typically, the Host chooses to reset the Drive. Since the Drive may not be able to prepare for such an abrupt termination, the action may have detrimental effects.

Commands are separated into two groups: Group 1 and Group 2. If a Group 1 command times out, the Host should retry the command. Group 2 commands should not be retried.

Group 3 timeout is a modified version of Group 1 timeout for streaming applications. Consequently, READ (12), VERIFY (10), and WRITE (12) may operate differently.

4.1.9.2 Group 1 Timeouts

Commands in Group 1 should always be retried when the Drive is ready. Commands with the Group 1 timeout are shown in Table 7.

Table 7 — Commands with Group 1 Timeout

Command	Operation Code	Command	Operation Code
GET PERFORMANCE	ACh	REPAIR TRACK	58h
MECHANISM STATUS	BDh	REPORT KEY	A4h
MODE SELECT	55h, 15h	REPORT LUNS	A0h
MODE SENSE	5Ah, 1Ah	REZERO UNIT	01h
PREFETCH	34h	SEEK	2Bh
PREVENT ALLOW MEDIUM REMOVAL	1Eh	SEND CUE SHEET	5Dh
READ	28h, A8h	SEND DISC STRUCTURE	BFh
READ BUFFER	3Ch	SEND EVENT	A2h
READ BUFFER CAPACITY	5Ch	SEND KEY	A3h
READ CAPACITY	25h	SEND OPC INFORMATION	54h
READ CD	BEh	SET CD SPEED	BBh
READ CD MSF	B9h	SET READ AHEAD	A7h
READ DISC INFORMATION	51h	SET STREAMING	B6h
READ DISC STRUCTURE	ADh	START STOP UNIT	1Bh
READ FORMAT CAPACITIES	23h	TEST UNIT READY	00h
READ SUB-CHANNEL	42h	WRITE	2Ah, AAh
READ TOC/PMA/ATIP	43h	WRITE BUFFER	3Bh
READ TRACK INFORMATION	52h	WRITE AND VERIFY	2Eh

If the Drive supports Group3 time-out and the G3Enable bit in Time-out & Protect Mode Page (1Dh) is set to 1, READ (12) with Streaming = 1 and WRITE (12) with Streaming = 1 are categorized as Group 3 time-out. Otherwise, the commands are Group 1.

The Group 1 time limit in the Timeout and Protect Page specifies a time limit for Group 1 commands. If Command Processing requires more than the allowed time, the command is terminated with CHECK CONDITION status and sense key shall be set to either NOT READY or UNIT ATTENTION and ASC shall be set to INSUFFICIENT TIME FOR OPERATION. Additionally, the Drive shall set the Command Specific Information sense bytes to the minimum timeout value in seconds that should be used when retrying the command. The Host's response should be to retry the command with the requested timeout.

The Drive is permitted to terminate the command prior to the timeout if it has determined that the command may not be completed within the allowed time.

4.1.9.3 Group 2 Timeouts

Group 2 contains commands that may be unable to complete successfully if retried. It is important that the Host specify a Group 2 timeout that is large enough to allow the command to complete under worst-case scenarios. Commands with the Group 2 timeout are shown in Table 8.

Table 8 — Group 2 Timeout Commands

Command	Operation Code	Command	Operation Code
BLANK	A1h	RESERVE TRACK	53h
CLOSE TRACK/SESSION	5Bh	SYNCHRONIZE CACHE	35h
FORMAT UNIT	04h	VERIFY (10)	2Fh
LOAD/UNLOAD MEDIUM	A6h	VERIFY (12)	Afh

If the Drive supports Group3 time-out and the G3Enable bit in Time-out & Protect Mode Page (1Dh) is set to 1, VERIFY (10) and VERIFY (12) are categorized as Group 3 time-out. Otherwise, the commands are Group 2.

If a Group 2 command has an immediate bit in its CDB and IMMED = 1, Timeout is not allowed for the command. Command status shall be returned within the Group 1 time.

4.1.9.4 No Timeout Commands

Some commands should be able to be processed with no dependence on the readiness of the mounted medium. These commands shall not timeout. These are listed in Table 5.

Table 9 — No Timeout Commands

Command	Operation Code	Command	Operation Code
GET CONFIGURATION	46h	RELEASE	17h, 57h
GET EVENT/STATUS NOTIFICATION	4Ah	REQUEST SENSE	03h
INQUIRY	12h	RESERVE	16h, 56h
RECEIVE DIAGNOSTIC RESULTS	1Ch	SEND DIAGNOSTICS	1Dh

4.1.9.5 Group 3 timeout for Real Time Stream Recording/Playback

4.1.9.5.1 General

Some Group 1 and Group 2 timeout commands become Group 3 timeout commands when G3tout in the READ/WRITE ERROR RECOVERY MODE PAGE is set to one. See Table 10.

Table 10 — Group 3 Timeout Commands

Command	Operation Code	Command	Operation Code
READ (12) when Streaming = 1	A8h	VERIFY (12)	Afh
VERIFY (10)	2Fh	WRITE (12) when Streaming = 1	AAh

To adjust application settings for real-time stream recording/playback to recover from a fatal error, estimation of the expected time length for the command is necessary. Group 3 time-out is defined for this purpose. The Group 3 time-out duration = Group3 time unit × Ceil(Transfer length / Unit length) + trace time for requested sectors where:

1. Ceil(x) is the least integer value greater than or equal to x.
2. Group 3 time unit is the maximum time to read or write one sector.
3. Unit length is the number of sectors that **may** be read or written within one Group 3 time unit.
4. Trace time is the time to read or write a sector excluding access time and the read/write time of the first sector.

The Group 3 time unit shows the maximum time of an operation when the transfer length field is set to 1 and when Power state of the Drive is Active state. In the case of DVD-RAM, the Group 3 time unit value should include Zone transition time.

The recommended value for Group 3 time unit is 1 to 5 seconds. The recommended value for Unit length is 256 sectors.

It is recommended that transfer length and verification length are set to smaller than the Unit length value. If the host uses transfer length less than the Unit length, the Group 3 time-out duration is almost the same as the Group 3 time unit as follows: (in the case of DVD, 256 sectors is only 0.38 second at 1× speed.)

Group 3 time-out duration = Group 3 time unit + trace time for requested sectors

The Group 3 time unit shall not be changed by a medium change. A Drive may accept the value changed by the host.

The value for Unit length is specific to the media type. A Drive should adjust the Unit length value according to the mounted media type.

Group 3 time-out duration of Group 3 time-out has following three exceptions.

1. Exception 1: Initial OPC time
2. Exception 2: Synchronize cache time
3. Exception 3: Power state transition time to Active state

The host is able to control the occurrence of these exceptions by commands (e.g., SEND OPC INFORMATION command, SYNCHRONIZE CACHE command). The Drive need not treat these exceptions as errors.

If Group 3 time-out is supported, G3tout bit of VERIFY (10) command shall be supported.

Group 3 time unit value shows the maximum time of operation when the transfer length field is set to 1 and when Power state of the Drive is Active state. In case of DVD-RAM, Group 3 time unit value should include 1 zone transition time.

The recommended value for Group 3 time unit is 1 to 5 seconds. The recommended value for Unit length is 256 sectors.

It is recommended that transfer length and verification length be smaller than the Unit length value. If the Host uses transfer length less than Unit length, the Expected time is similar with Group 3 time unit. That is, Expected time = Group3 time unit + trace time for requested blocks.

4.1.9.5.2 Trace time for requested sectors

Group 3 time unit value shows the minimum time of the operation when the transfer length field is set to 1. If transfer length is larger than 1, Group 3 time-out duration is increased to reflect the transfer length of the command. For example, in case of DVD media operating at 1x speed, a read operation requires 1,48 ms/sector. If the Group 3 time value is 3 seconds and transfer length is 160, the Group 3 time-out duration is 3.24 second ($= 3 + 0.00148 \times (160 - 1)$).

When the transfer length field READ (12)/WRITE (12) command is 32 or less, the trace time for the requested sectors is very small compared with the Group 3 time unit value. Consequently, trace time is typically negligible.

4.1.9.5.3 Exception 1: Time for the initial OPC

Optimum Power Calibration before a write operation takes several seconds. When OPC is performed, a Drive may expand the Group 3 time-out duration with extra time for the initial OPC. That is, Group 3 time-out duration with OPC = time for the initial OPC + Group 3 time-out duration.

To avoid this exception, the host should issue the SEND OPC INFORMATION command with DoOpc = 1.

A Drive should not perform time consuming internal OPC (Subsequent OPC) during real-time stream recording at the WRITE (12) command with Streaming=1. A WRITE (10)/WRITE (12) command with Streaming=0 and SEND OPC INFORMATION command with DoOpc = 1, the Drive may perform the Subsequent OPC if necessary. The host may pause the real-time streaming recording and issue SEND OPC INFORMATION command with DoOpc = 1.

Reporting of CHECK CONDITION status, 2/04/08 DRIVE NOT READY, LONG WRITE IN PROGRESS to avoid the time-out of WRITE (12) command with Streaming=1 due to insufficient buffer capacity may hide the Exception 1. However, it is not recommended to use this operation for the Subsequent OPC.

4.1.9.5.4 Exception 2: Sync cache time

If a Drive has write data in its buffer when the Drive receives a READ (12) command with Streaming=1 or a VERIFY (10) command with G3tout=1, the Drive shall write the buffered data. The Drive shall then read the requested blocks. In this case, additional Group 3 time-out duration for synchronize cache is added to the Group 3 timeout duration for READ (12) command with Streaming=1 and VERIFY (10) command with G3tout=1. That is, Expected time for synchronize cache = Group 3 time unit + time to synchronize the buffered data, and Group 3 time-out duration with synchronize cache = Expected time for synchronize cache + Group 3 time-out duration.

A host is able to determine the Group 3 time-out duration for synchronize cache via the READ BUFFER CAPACITY command. For example, if a Drive has 2 Mbytes buffer, the Drive may have about 60 ECC blocks of write data in buffer. For DVD media operating at 1x speed, if the Group 3 time value is 3 seconds, the expected time for synchronize cache is 4.42 seconds ($= 3 + 0.00148 \times (960 - 1)$).

To avoid this exception, a host should issue the SYNCHRONIZE CACHE command.

4.1.9.5.5 Exception 3: Power state transition time to Active state

When a Drive is in Idle state or Standby state, the Drive needs a few seconds to be Active state before a operation. When Power state transition is performed, the Drive may exceed Group 3 time-out duration with extra time for the Power state transition. That is, Group 3 time-out duration with Power state transition = time for the Power state transition + Group 3 time-out duration.

To avoid this exception, the host should issue the START/STOP UNIT command with Start = 1, LoEj = 0 and Power Condition = 0.

4.1.9.5.6 Relationship between Group 3 time unit and Unit length

The Group 3 time-out duration of the command termination is increased by Group 3 time unit when the transfer block length is increased by Unit length as shown in Figure 8. Because changing Group 3 time unit causes big direct impact to host software, the Group 3 time unit value shall not be changed by medium change. If adjustment of the Group 3 timeout duration of the command termination time on different media is necessary, different Unit length value for different media shall be used.

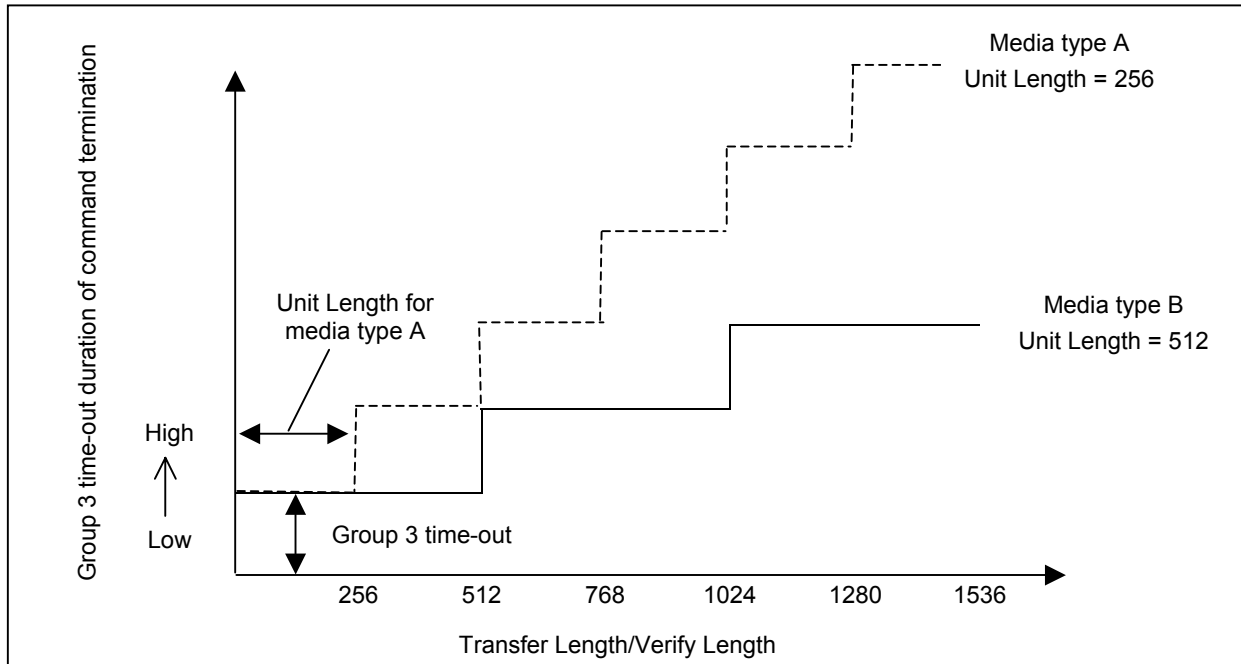

Figure 8 — Adjustment of Command Termination Time on Different Media

4.1.9.6 Recommended Timeout value handling

The Group 1 Minimum Time-out field, the Group 2 Minimum Time-out field, and the Group 3 Time unit field in the Time-out and Protect Mode Page (1Dh) may not be changeable. Even if the field is changeable, a Drive may round up the host specified value, because the Drive may have its own minimum time to perform retry in a command. The host should check the changeable status of these fields by issuing the MODE SENSE (10) command with the Changeable Value of PC field prior to issuing the MODE SELECT (10) command. Once values are selected, the host should check the selected value by issuing MODE SENSE (10) command.

Specific timeout actions are included with each command description in clause 6.

4.1.10 Power Management

Power conditions permit the Host to modify the behavior of a MM Drive in a manner that may reduce the required power. The Host may determine the current power state by issuing the GET EVENT STATUS NOTIFICATION command and requesting Power Management Events (See 6.7.2.3). Power conditions may be controlled by either the START STOP UNIT command or the Power Condition mode page. See the START STOP UNIT command description (6.39) and the Power Condition mode page description (7.7) for more information. Table 11 shows the defined power conditions.

Table 11 — Power Conditions

Power Condition	Definition
Sleep	The lowest power consumption, with power applied, occurs in the Sleep condition. When in the Sleep condition a MM Drive requires a WAKEUP task management function to be activated.
Standby	In the Standby condition a MM Drive is capable of accepting commands, but media is not immediately accessible (e.g., the spindle is stopped).
Idle	In the Idle condition a MM Drive is capable of responding quickly to media access requests. However, a MM Drive in the idle condition may take longer, than in the active condition, to complete the execution of a command because it may have to activate some circuitry.
Active	In the Active condition a MM Drive is capable of responding immediately to media access requests, and operations complete execution in the shortest time compared to the other power conditions.

No Drive power condition change shall affect other devices connected to the physical interface.

MM Drives that contain cache memory shall implicitly perform a SYNCHRONIZE CACHE command for the entire medium prior to entering any power condition that prevents access the media (e.g., the spindle being stopped).

4.2 Compact Disc (CD)

4.2.1 Recorded CD Media Structure

4.2.1.1 Spiral Structure

The recorded spiral of a CD follows the general MM disc structure of single layer media as described in 4.1.2. CD has some variation as shown in Table 12.

Table 12 — General CD Spiral Structure

General Zone	CD Terminology	Zone Description
Inner Zone	—	Recordable and Rewritable CDs contain zones prior to the Lead-in for calibration and incremental recording management.
Lead-in	Lead-in	The disc lead-in contains the Table of Contents (TOC) that describes the recorded content of some or the entire disc.
Data Zone	Program Area	A CD program area represents the LBA space of the disc.
Lead-out	Lead-out	For most CD formats the lead-out is only a seek overshoot zone.

4.2.1.2 The CD Frame Structure

The recorded CD spiral is recorded in a continuous stream of data groups called Small Frames. The Small Frame carries 1 byte of sub-channel and 24 bytes of user data (also known as main channel data). The user data is protected by 2 layers of error correction known as C1 and C2. See Table 13.

Table 13 — Small Frame Content

Small Frame Data	Size in Bytes
User Data	24
C2 ECC symbols	4
C1 ECC symbols	4
Sub-channels	1

A CD frame consists of 98 contiguous Small Frames. This yields $24 \times 98 = 2352$ bytes of main channel data per frame and 98 bytes of Sub-channel data per CD frame.

A recorded CD is a succession of CD frames. For audio, the bounds of a Frame are defined by the Sub-channel bytes. For data, the bounds are determined by a sync pattern in the main channel data.

The 98 Sub-channel bytes are separated into 2 bytes of synchronization and 96 bytes of data. Each CD frame begins with the first Sub-channel sync byte and ends with the 96th Sub-channel data byte. A CD frame is constructed from Small Frames as shown in

Table 14. This is a logical representation since Small Frames are physically interleaved. This means that precise CD frame boundaries do not exist.

Table 14 — CD Frame Structure from Small Frames

FRAME N

	Small Frame 96	Sub-channel Data Byte 94	24 bytes main channel data
	Small Frame 97	Sub-channel Data Byte 95	24 bytes main channel data
	Small Frame 98	Sub-channel Data Byte 96	24 bytes main channel data
FRAME N+1	Small Frame 1	Sub-channel Sync Byte 1	24 bytes main channel data
	Small Frame 2	Sub-channel Sync Byte 2	24 bytes main channel data
	Small Frame 3	Sub-channel Data Byte 1	24 bytes main channel data

	Small Frame 98	Sub-channel Data Byte 96	24 bytes main channel data
FRAME N+2	Small Frame 1	Sub-channel Sync Byte 1	24 bytes main channel data
	Small Frame 2	Sub-channel Sync Byte 2	24 bytes main channel data
	Small Frame 3	Sub-channel Data Byte 1	24 bytes main channel data

4.2.1.3 Sub-channel

Each non-sync byte of Sub-channel is labeled according to bit position, See Table 15.

Table 15 — Sub-Channel byte layout

Small Frame Sub-channel Byte							
P	Q	R	S	T	U	V	W
Bit 7	Bit 6	Bit 5	Bit 4	Bit 3	Bit 2	Bit 1	Bit 0

Over the 98 Small Frames, the Sub-channel is separated into bytes associated with the Sub-channel letter. The Sub-channel sync bytes are not a part of Sub-channel data, so there are 96 bytes of Sub-channel. e.g., the P Sub-channel is separated into bytes as shown in

Table 16.

Table 16 — P-Sub-Channel Layout

Small Frame	P Bit	P Byte
1	SYNC 0	-
2	SYNC 1	-
3	7	0
4	6	
5	5	
6	4	
7	3	
8	2	
9	1	
10	0	
11	7	1
12	6	
13	5	
14	4	
15	3	
16	2	
17	1	
18	0	
•	•	•
•	•	•
•	•	•

•	•	•
•	•	•
•	•	•
83	7	10
84	6	
85	5	
86	4	
87	3	
88	2	
89	1	
90	0	
91	7	11
92	6	
93	5	
94	4	
95	3	
96	2	
97	1	
98	0	

The byte construction for other (Q – W) Sub-channels is identical.

P and Q Sub-channels provide information about the recording.

R-W Sub-channel is defined only for audio tracks. When used, it carries line graphics, MIDI Control, or text. In that case, specific formatting of the resulting data defines the meaning. Consult the appropriate format documents. For data tracks, R-W sub-channels shall be set to zeros.

4.2.2 Physical Track Topology: Single Session Disc

CD players and readers follow the spiral by following the path of recorded data. When there is no recorded data, the player/reader is unable to follow the spiral.

The spiral is divided into 3 logical entities from the inner radius as shown in Figure 9.

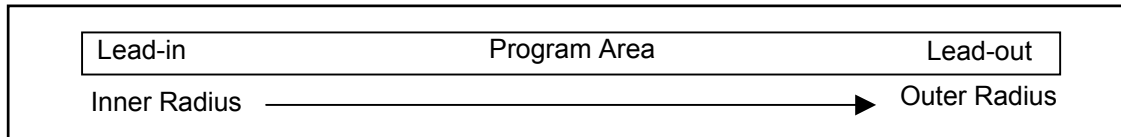

Figure 9 — Single Session disc

LEAD-IN – The Lead-in is a zone of protection from unrecorded areas near the disc center. The Lead-in also contains the table of contents (TOC) for the disc's Program Area.

PROGRAM AREA – This is the CD term for the Data Zone.

LEAD-OUT – The Lead-out is a zone of seek overshoot protection from the disc's outer edge.

4.2.3 Physical track topology – Multi-Session Disc

4.2.3.1 Sessions

A Session is the recorded sequence: Lead-in, program area, Lead-out. The multi-session allows a single disc to have several concatenated sessions.

CD-ROM devices are not typically capable of reading through unrecorded areas on the medium. The CD-ROM device needs recorded data in order to find and stay in the spiral. This means that to ensure that a CD-ROM Drive is capable of accessing all areas of a Program Area; the Program Area needs the protection zones of Lead-in and Lead-out. On a recorded disc, sessions may appear as shown in Figure 10.

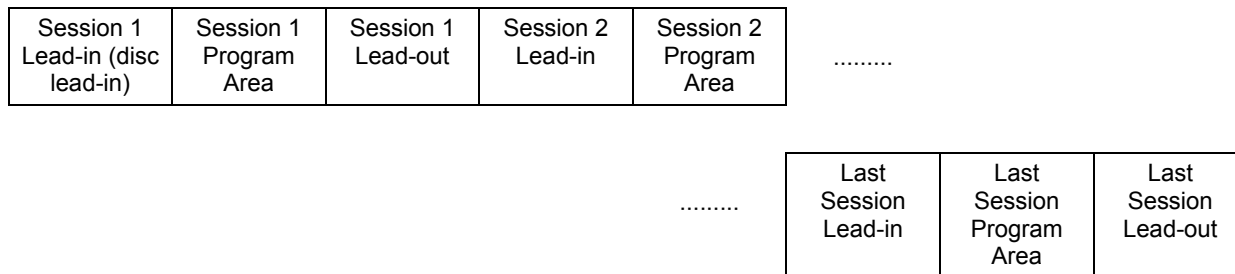

Figure 10 — Multi-Session Recorded Disc

In order to assure readability by CD-ROM Drives, the recording system should always close the session with the most recently added program area before attempting interchange.

Additional information is needed in order to locate all of the program areas. This is accomplished by using Mode 5 Q in the Lead-in areas.

4.2.3.2 Tracks

The Program Area of the disc is divided into logically separated areas called tracks. There shall be at least one track in the Program Area. There may be gaps between tracks, primarily to provide a zone of digital silence between audio program selections. P Sub-channel is reserved for identifying these transition areas between tracks. The value of P is normally 0, but during a transition area, the value for P is 1.

4.2.3.3 Frame Addressing

CD was originally developed for playing digital audio that has two channels of 16-bit samples at 44.1KHz. The number of frames per second of play is 75:

$$\begin{aligned} \text{bytes/Sample} * 44\ 100 \text{ Samples/second} &= 176\ 400 \text{ bytes/second, and} \\ 176\ 400 \text{ bytes/second} / 2\ 352 \text{ bytes/frame} &= 75 \text{ frames/second} \end{aligned}$$

Given this, CD frames are addressed in terms of audio play time, i.e., Minute, Second, and Frame (MSF). The traditional value of 60 seconds per minute is followed.

In all cases, when an address appears as part of the CD format, it is in MSF format using 2 bcd digits per time unit. This limits the time addressing on the disc to 99bcd minutes. The representation for a time based address is MM:SS:FF, where MM = minutes, SS = seconds, and FF = frames.

Addressing in the program area begins with 00:00:00. This advances up through the Lead-out.

The last frame in the Lead-in is 99:59:74 and decreases as the spiral is followed toward the center of the disc. The Lead-in is typically 3 to 4 minutes in length.

4.2.3.4 Q Sub-channel

Since an audio CD frame has no address field built into the main channel, the address is carried in the Q Sub-channel. Q Sub-channel may also carry information about the logical structure of the disc, disc identification, and music track identification. The general format of a Q Sub-channel record is shown in Table 17.

Table 17 — Q Sub-channel record format

Field name	Definitions
S0, S1	Sub-channel Synchronization
CONTROL	<p>The Control Field has 4 bits that define the type of information in the frame:</p> <p>00x0b = 2 audio channels without pre-emphasis 00x1b = 2 audio channels with pre-emphasis of 50/15 μs 10x0b = 4 audio channels without pre-emphasis 10x1b = 4 audio channels with pre-emphasis of 50/15 μs 01x0b = Data track, recorded uninterrupted 01x1b = Data track, recorded increment 11xxb = reserved xx0xb = digital copy prohibited xx1xb = digital copy permitted</p> <p>The bits of the control field (except for the copy bit) may change during a pause (X=00) of at least 2 seconds and during the Lead-in area only.</p>
ADR	4 bits of identification for DATA-Q. This is also known as the Mode (ADR) Q.
DATA Q	72 bits of data
EDC	A 16 bit EDC for the Control, ADR, and DATA-Q Fields. On the disc the EDC bits are inverted. The remainder has to be checked at zero.

Because the sync bits and the two bytes of EDC are overhead, the valid Q information length is actually 10 bytes.

4.2.3.5 Q Sub-channel in the Program Area

4.2.3.5.1 Types of Q

During the program area 3 types of Q Sub-channel may be encountered, Mode-1 Q, Mode-2 Q, or Mode-3 Q.

4.2.3.5.2 ADR=1 (0001b) – Mode-1 Q

Mode 1 Q occupies at least 9 out of 10 successive CD frames. Mode-1 Q in the program area is also referred to as current position Q. The Mode-1 Q format during data and audio tracks is shown in Figure 11.

ADR	DATA-Q								
0001	TNO	INDEX	MIN	SEC	FRAME	ZERO	AMIN	ASEC	AFRAME

Figure 11 — Q Sub-channel Mode-1 Format recorded in Program Area

TNO	=	01 to 99bcd is the track number
INDEX	=	00 to 99bcd is the Index to TNO. An audio track may be divided into up to 99 sections, identified by a non-zero index. The first indexed area in a track shall be 01. Most audio discs have only one indexed area per track. The pre-gap is the part of a track-to-track gap that belongs to the following track. In a track's pre-gap, the track number is that of the following track and the INDEX is 00.
MIN, SEC, FRAME	=	Is the relative time within the track encoded as 6 BCD digits. This is 00:00:00 at track start and advances through the track. During the pre-gap the time decreases.
ZERO	=	8 bits of zero (00000000b)
AMIN, ASEC, AFRAME	=	Is the program area absolute time address expressed in 6 BCD digits.

4.2.3.5.3 ADR=2 (0010b) – Mode-2 Q

Mode-2 Q is optional. If Mode-2 Q is present, it shall occupy at least 1 out of each 100 successive frames. The Mode-2 Q data format is shown in Figure 12.

ADR	DATA-Q														
0010	N1	N2	N3	N4	N5	N6	N7	N8	N9	N10	N11	N12	N13	ZERO	AFRAME

Figure 12 — Q Sub-channel Mode-2 Format

The DATA-Q field is 52 bits long, organized as 13 nibbles (N1 – N13), each carrying a single BCD digit. The resulting BCD string is the Media Catalog Number (MCN). The catalog number does not change on a disc. In case no catalog number is encoded according to the UPC/EAN code, N1 – N13 are all zero, or Mode-2 may be deleted from the disc.

The ZERO field contains 12 bits of zero. (000000000000b)

AFRAME is as defined in Q Sub-channel Mode-1 (two BCD digits running from 00 to 74). During the Lead-in (TNO = 00), these 8 bits are zero.

4.2.3.5.4 ADR=3 (0011b) – Mode-3 Q

Mode-3 Q is optional. If Mode-3 is present, it shall occupy at least 1 out of 100 successive sub-coding blocks. Mode-3 is used to give a unique number to an audio track. This is done by means of the International Standard Recording Code (ISRC). If no ISRC is used, Mode-3 shall be deleted. During the Lead-in and Lead-out, Mode-3 is not present on the disc. The ISRC may only change immediately after the Track Number (TNO) has been changed. The Mode-3 data format is shown in Figure 13.

ADR	DATA-Q															
0011	I1	I2	I3	I4	I5	0	0	I6	I7	I8	I9	I10	I11	I12	ZERO	AFRAME

Figure 13 — Q Sub-channel, Mode-3 Format

The Country-Code is given in fields I1 through I2, the owner-code in fields I3 – I5, The year of recording in fields I6 – I7 and the I8 through I12 contain the serial number of the recording. The characters I1 – I5 are 6-bit cells, coded as shown in Table 18. The characters I6 – I12 are coded in 4 bit BCD numbers.

I1 – I12 define the ISRC.

The ZERO Field contains 4 bits of zero. (0000b)

AFRAME is defined in Q Sub-channel Mode-1 Q (two BCD digits running from 00 to 74).

Table 18 — ISRC 6 bit character codes (in hexadecimal)

CHAR	CODE	CHAR	CODE
0	00	I	19
1	01	J	1A
2	02	K	1B
3	03	L	1C
4	04	M	1D
5	05	N	1E
6	06	O	1F
7	07	P	20
8	08	Q	21
9	09	R	22
A	11	S	23
B	12	T	24
C	13	U	25
D	14	V	26
E	15	W	27
F	16	X	28
G	17	Y	29
H	18	Z	2A

4.2.3.6 Q Sub-channel in the Lead-out Area

Q Sub-channel in the Lead-out area is similar to Q Sub-channel in the program area. The differences are:

Mode-1 Q Sub-channel: TNO = AAh, INDEX = 01bcd

Mode-2 Q Sub-channel: No differences.

No other Q Sub-channel modes are allowed in the Lead-out area.

4.2.3.7 Q Sub-channel in the Lead-in Area

4.2.3.7.1 Types of Q

Q Sub-channel in the Lead-in area is referred to as the Table of Contents (TOC).

Three modes of Q are allowed in the Lead-in area: Mode-1 Q, Mode-2 Q, and Mode-5 Q.

4.2.3.7.2 Mode-1 Q

The Mode-1 Q format during the Lead-in is shown in Figure 14. TNO is always 00 during the Lead-in and ZERO is always 00 during the Lead-in. Variations of Mode-1 Q are defined by the value of POINT.

ADR	DATA-Q								
0001	TNO=00	POINT	MIN	SEC	FRAME	ZERO=00	PMIN	PSEC	PFRAME

Figure 14 — Q Sub-channel Mode-1 Format recorded in Lead-in

POINT = 01bcd – 99bcd is the track number of the track being defined.

MIN, SEC, FRAME	=	Running time in the Lead-in, encoded as BCD
PMIN, PSEC, PFRAME	=	Track start time, encoded as BCD
POINT = A0h		
MIN, SEC, FRAME	=	Running time in the Lead-in, encoded as BCD
PMIN	=	Track number of the first track in the program area, encoded as BCD
PSEC	=	Program area format: 00h - CD-DA or CD-ROM 10h - CD-I 20h - CD-ROM-XA
PFRAME	=	0
POINT = A1h		
MIN, SEC, FRAME	=	Running time in the Lead-in, encoded as BCD
PMIN	=	Track number of the last track in the program area, encoded as BCD
PSEC, PFRAME	=	0, 0
POINT = A2h		
MIN, SEC, FRAME	=	Running time in the Lead-in, encoded as BCD
PMIN, PSEC, PFRAME	=	Start time of Lead-out, encoded as BCD

4.2.3.7.3 Mode-2 Q

Mode-2 Q Sub-channel is defined the same in the Lead-in, program area and Lead-out.

4.2.3.7.4 Mode-5 Q

Mode-5 Q Sub-channel provides additional information about CD-R and CD-RW recordings. The format of a Mode-5 Q Sub-channel is shown in Figure 15. TNO is always 00 during the Lead-in. Variations of Mode-5 Q are defined by POINT.

ADR	DATA-Q								
	0101	TNO	POINT	MIN	SEC	FRAME	ZERO	PMIN	PSEC

Figure 15 — Q Sub-channel Mode-5 Format recorded in Lead-in

POINT = 01...40 (Audio only: This identifies a specific playback skip interval)

MIN, SEC, FRAME = Skip interval stop time in 6 BCD digits
 ZERO = 00
 PMIN, PSEC, PFRAME = Skip interval start time in 6 BCD digits

POINT = B0h (multi-session disc)

MIN, SEC, FRAME = the start time for the next possible session's program area. A final session is indicated MIN, SEC, FRAME = FFh:FFh:FFh or when the Mode-5 point B0 is absent.
 ZERO = the number of different Mode-5 pointers present.
 PMIN, PSEC, PFRAME = the maximum possible start time of the outermost Lead-out

POINT = B1h (Audio only: This identifies the presence of skip intervals)

MIN, SEC, FRAME = 00, 00, 00
 ZERO = 00
 PMIN = the number of skip interval pointers
 PSEC = the number of skip track assignments in POINT=B2, B3, and B4
 PFRAME = 00

POINT = B2h, B3h, B4h (Audio only: This identifies tracks that should be skipped during playback)

MIN = 01-99bcd, track number to skip upon playback
 SEC = 00-99bcd, track number to skip upon playback,
 00 if no skip track is specified
 FRAME = 00-99bcd, track number to skip upon playback,
 00 if no skip track is specified
 ZERO = 00
 PMIN = 00-99bcd, track number to skip upon playback,
 00 if no skip track is specified
 PSEC = 00-99bcd, track number to skip upon playback,
 00 if no skip track is specified
 PFRAME = 00-99bcd, track number to skip upon playback,
 00 if no skip track is specified

Note 1. Skip intervals are seldom written by recorders and typically ignored by readers.

POINT = C0h (Together with POINT=B0h, this is used to identify a multi-session disc)
 MIN, SEC, FRAME = ATIP values from Special Information 1, ID=101
 ZERO = 00
 PMIN, PSEC, PFRAME = Start time of the first Lead-in area of the disc

4.2.3.8 CD Main Channel Block Formats

4.2.3.8.1 General Data Block Format

Although some are rarely used, there are 6 main channel frame formats defined. Audio blocks are recorded unmodified. Data blocks are given a synchronization field at the beginning of the block. The pattern is shown in Figure 16.

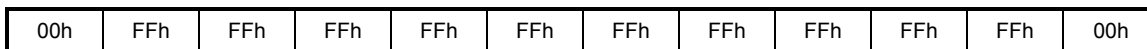

Figure 16 — Synchronization Field pattern

The synchronization field is followed by a 4 byte header defined in Table 19. After the sync pattern the remaining bytes of the data block are scrambled with a feedback mechanism. This is done with a 15-bit shift register fed back according to the polynomial $X^{15}+X+1$.

Table 19 — Sync Pattern Block Header

Header Offset	Header Byte	Content
0	Minute	Program area time of block, minute component (00-79 bcd)
1	Second	Program area time of block, second component (00-59 bcd)
2	Frame	Program area time of block, frame component (00-74 bcd)
3	Mode	Bits 1, 0 = Data Mode, Bits 7 - 5 = block indicator field, Bits 4 - 2 = Reserved. When Bits 7 - 5 = 000 indicates user data.

Mode byte Format is:

- | | | | |
|--------------|-------|---|--------------------------------------|
| Bits 7, 6, 5 | = 000 | - | User Data block |
| | = 001 | - | Fourth Run-in block |
| | = 010 | - | Third Run-in block |
| | = 011 | - | Second Run-in block |
| | = 100 | - | First Run-in block |
| | = 101 | - | Link block. Physical linking of data |
| | = 110 | - | Second Run-out block |
| | = 111 | - | First Run-out block |
| Bits 4, 3, 2 | = 000 | - | Reserved |
| Bits 1, 0 | = 00 | | Mode 0 Data |
| | = 01 | - | Mode 1 Data |
| | = 10 | - | Mode 2 Data |
| | = 11 | - | Reserved |

4.2.3.8.2 Block Format for Audio

Audio is streamed, so only user data resides within the frame. See 6.20.3.1.3.

4.2.3.8.3 Block Format for Mode 0 Data

Mode 0 is a rarely used format as it is zero filled in the entire user data area. Mode zero data (Table 20) has the following format.

Table 20 — Mode Zero Data Format

Byte Offset	Field Length	Content
0	12	Data Block Sync pattern
12	3	Block MSF address (BCD)
15	1	Data mode = 0
16	2 336	User data (each byte is zero)

4.2.3.8.4 Block Format for Mode 1 Data

Mode 1 data (Table 21) is most prevalent in CD-ROM applications. The sync pattern, header and user data are protected by a 32-bit EDC. Two additional layers of error correction, P and Q, collectively called Level 3 correction cover the header and user data. This is also referred to as Layered error correction (L-EC or C3).

Table 21 — Mode 1 Data Format

Byte Offset	Field Length	Content
0	12	Data Block Sync pattern
12	3	Block MSF address (BCD)
15	1	Data mode = 01
16	2 048	User data
2 064	4	EDC
2 068	8	Zero fill
2 076	172	P parity symbols
2 248	104	Q parity symbols

The coverage of the EDC is the sync pattern, Header, and the User Data.

The coverage of Level 3 P is Header, User Data, EDC, and the zero fill.

The coverage of Level 3 Q is Header, User Data, EDC, the zero fill, and the P parity.

4.2.3.8.5 Block Format for Mode 2 Data

4.2.3.8.5.1 Forms of Mode 2

Mode 2 data blocks have two types: formless and formed. Mode 2 formed blocks have two forms: form 1 and form 2.

4.2.3.8.5.2 Block Format for Mode 2 formless Data

The Mode 2 formless block format (Table 22) is rarely used. There is no defined EDC or additional correction.

Table 22 — Mode 2 formless block format

Byte Offset	Field Length	Content
0	12	Data Block Sync pattern
12	3	Block MSF address (BCD)
15	1	Data mode = 2
16	2 336	User data

4.2.3.8.5.3 Block Format for Mode 2 form 1 Data

The Mode 2 form 1 block format (Table 23) is regularly used in recorder applications and Video CD movies. The Mode 2 form 1 format is very similar to Mode 1 format. The differences are:

- The 8 zero fill bytes have been moved to between the header and user data as two copies of a 4 byte sub-header.
- The EDC, P-parity, and Q-parity do not cover the block header. This assures the ability of relocating data, including all parity symbols.

Table 23 — Mode 2 form 1 data format

Byte Offset	Field Length	Content
0	12	Data Block Sync pattern
12	3	Block MSF address (BCD)
15	1	Data mode = 2
16	4	Sub-header, first copy
20	4	Sub-header, second copy
24	2 048	User data
2072	4	EDC
2076	172	P parity symbols
2248	104	Q parity symbols

The format of the sub-header is shown in Table 24.

Table 24 — Mode 2 Formed Sector Sub-header Format

Sub-Header Byte	Byte Name	Definition
0	File number	Identifies the file to which the block belongs
1	Channel number	Playback channel selection
2	Sub-mode	Bit 7: End-of-File
		Bit 6: Real-time block
		Bit 5: Form (0 = Form 1, 1 = Form 2)
		Bit 4: Trigger Block
		Bit 3: Data Block
		Bit 2: Audio Block (not traditional CD-DA audio)
		Bit 1: Video Block
3	Coding information	Bit 0: End-of-Record

4.2.3.8.5.4 Block Format for Mode 2 form 2 Data

Mode 2 form 2 data (Table 25) is regularly used in Video CD movies. The data is optionally covered by EDC within the last 4 bytes of the block.

Table 25 — Mode 2 form 2 data format

Byte Offset	Field Length	Content
0	12	Data Block Sync pattern
12	3	Block MSF address (BCD)
15	1	Data mode = 2
16	4	Sub-header, first copy
20	4	Sub-header, second copy
24	2 324	User data
2 348	4	Optional EDC over Bytes 16 – 2 347

4.2.3.9 CD Recordable and CD ReWritable Media Structure

4.2.3.9.1 ATIP

An unrecorded CD-R or CD-RW media has no data available for locating the spiral in the traditional way of CD-ROM Drives. A blank CD-R/CD-RW is not smooth. It is pre-grooved with a built-in wobble for the purpose of defining the spiral.

The wobble is a 22,05 kHz signal (at 1X) modulated with digital information. The information recorded within the pre-groove defines frames of 42 bits. This is known as Absolute Time In Pre-groove (ATIP, see Figure 17).

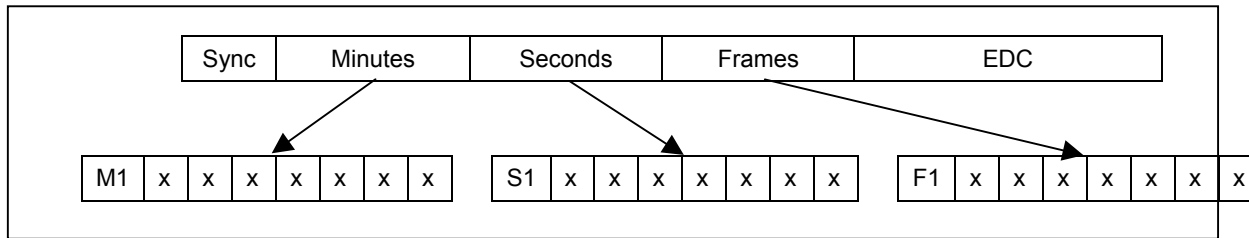

Figure 17 — ATIP Data

The area from any ATIP sync to the next ATIP sync is called an ATIP frame. Each ATIP frame defines the recording area for a CD sector. The information carried within an ATIP frame is 3 bytes labeled M, S, and F. The high order bit of each byte (M1, S1, F1) is used to identify the information contained within the remaining 21 bits. Specific information on capturing and decoding ATIP frame data is found in [CD-Ref6], [CD-Ref7], [CD-Ref8], [CD-Ref9], and [CD-Ref10].

ATIP information types are listed in Table 26.

Table 26 — ATIP Information Types

M1, S1, F1	ATIP Type Name	ATIP Data Content
000b	Time Code	ATIP frame location
001b	Additional Information 1	Recording speed and additional capacity parameters
010b	Additional Information 2	Recording speed parameters
011b	Additional Information 3	Media identification
100b	Time Code	ATIP frame location
101b	Special Information 1	Application code, Disc Type
110b	Special Information 2	Start time of disc's lead-in
111b	Special Information 3	CD-R: Last Possible Start Time of last Lead-out when Special Information 1 is present in lead-in. CD-R: Start time of additional capacity when Additional Information 1 is not present in lead-in, but present in the PCA1 area. CD-RW: Last Possible Start Time of last Lead-out

4.2.3.9.2 ATIP Time Codes

Time codes are presented as MSF with each byte encoded in bcd. The M1, S1, and F1 bits (000b or 100b) are considered a part of the time code. The starting ATIP time code on the disc is typically larger than 95:00:00. As the pre-groove is followed from the inner radius, time codes increment by one frame per ATIP frame until 99:59:74 is reached. The next ATIP frame has time code 00:00:00 – the start of the program area. ATIP frame time codes continue incrementing by one frame until 99:59:00 is reached. If the disc has capacity remaining, the high order 4-bits of the minute field continues to increment past 9, while all other digits are held to bcd encoding. See Figure 18.

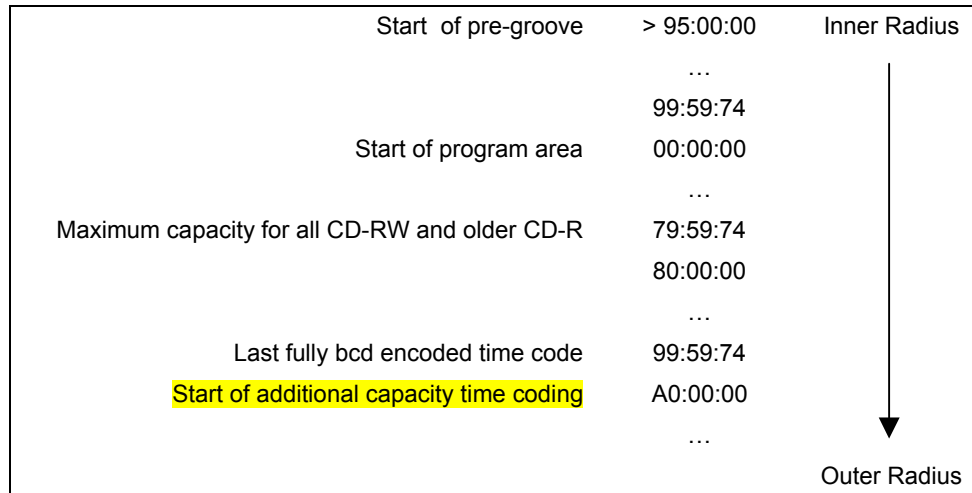

Figure 18 — Time Codes in CD-R and CD-RW Pre-groove

4.2.3.9.3 Special Information

Special Information types 1, 2, and 3:

- are present on all CD-R and CD-RW media,
- are interleaved between ATIP time code frames within the area that precedes the program area,
- do not appear before the MSF address in Special Information 2 (Start Time of Disc's lead-in).

Special Information 1 (SI1) includes:

- suggested write power,
- reference write speed,
- disc application code,
- a disc type bit (R = 0, RW = 1),
- a disc sub-type code (contains valid information only for CD-RW media),
- three presence bits for Additional Information 1, 2, and 3.

Special Information 2 (SI2) contains the ATIP time code that corresponds to the disc's lead-in address.

Special Information 3 (SI3) has 2 possible meanings:

- on media defined in [CD-Ref6] (CD-R), the ATIP time code that corresponds to the recommended disc's lead-out start address.
- on media defined in [CD-Ref7] (Multi-Speed CD-R) and [CD-Ref8] (High Capacity CD-R), this address corresponds to the start of additional capacity. The recommended disc's lead-out stop address is calculated by adding the additional capacity indicated from Additional Information 1 to this ATIP time code value.

4.2.3.9.4 Additional Information

Additional Information 1 (AI1):

- a) appears on all recordable and rewritable media,
- b) on media as defined in [CD-Ref6] (CD-R) AI1 is found in the disc lead-in area and the disc lead-out area.
- c) on media as defined in [CD-Ref9] (CD-RW) AI1 is found in the 30 seconds prior to the disc lead-in,
- d) on media as defined in [CD-Ref7] (Multi-Speed CD-R) AI1 is found in the disc lead-in.

Additional Information 2 (AI2):

- a) on media as defined in [CD-Ref6] (CD-R) and [CD-Ref9] (CD-RW) AI2, is not defined,
- b) on media as defined in [CD-Ref7] (Multi-speed CD-R), AI2 is found in the 30 seconds prior to the disc lead-in.

Additional Information 3 (AI3):

- a) on media as defined in [CD-Ref6] (CD-R) and [CD-Ref9] (CD-RW) AI3, is not defined,
- b) on media as defined in [CD-Ref7] (Multi-speed CD-R), AI3 is found in the 30 seconds prior to the disc lead-in.

4.2.3.10 Blank Media Structure

4.2.3.10.1 CD-R Volume 1 and CD-RW

There are two additional areas prior to the disc Lead-in (Figure 19), the Power Calibration Area (PCA), and the Program Memory Area (PMA).

The Power Calibration Area is present only for CD-R and CD-RW media for the purpose of write power calibration. The PCA is divided into two areas: the test area and the count area. The test area is divided into 100 calibration partitions. The count area is an accounting area for recording usage of the test area.

The Program Memory Area is present only for CD-R and CD-RW media for the purpose of accounting for the usage of user data areas on the medium. This information is contained only within the Sub-channel of the PMA frames. The main channel content is not defined within the PMA.

Update the PMA means to update the PMA on the disc or to update the PMA Cache that shall be written to the PMA on the disc prior to the removing the disc from the Drive. PMA Caching is vendor specific.



Figure 19 — CD-R Volume 1 and CD-RW Structure

4.2.3.10.2 Multi-Speed and High Capacity CD-R

Multi-Speed and High capacity CD-R media described in [CD-Ref7] and [CD-Ref10] have two PCAs. PCA1 is in the same location and has the same length as the PCA on media according to [CD-Ref6]. PCA2 begins after the last lead-out on the disc and is minimally the same size as PCA1. Other areas of media according to [CD-Ref7] and [CD-Ref8] have the same definitions as for media according to [CD-Ref6]. See Figure 20.

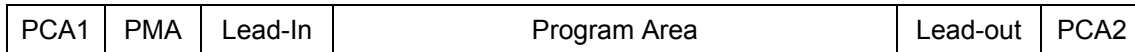

Figure 20 — Multi-Speed and High capacity CD-R Structure

4.2.3.10.3 PMA Q Sub-channel

The PMA is a temporary TOC to be used as a disc is being recorded in increments. The format of the Q Sub-channel for PMA entries is similar to those in the Lead-in.

The PMA is recorded in groups of 10 frames called a PMA unity. If any of the frames in a unity is recorded, then all frames in the unity shall be recorded. A given PMA entry shall appear either 5 or 10 times within a unity.

Q Sub-channel in the PMA has the general form shown in Figure 21.

ADR	DATA-Q								
0001-0110	TNO	POINT	MIN	SEC	FRAME	ZERO	PMIN	PSEC	PFRAME

Figure 21 — PMA, Q Sub-channel

Mode-1 Q Sub-channel in the PMA is a TOC item:

TNO	=	00
POINT	=	Track number encoded as two BCD digits.
ZERO	=	00-09bcd is a label of the frame number in the PMA unity
MIN, SEC, FRAME	=	Track stop time in 6 BCD digits.
PMIN, PSEC, PFRAME	=	Track start time in 6 BCD digits.

Mode-2 Q Sub-channel in the PMA is a Disc Identification item (optional):

TNO	=	00
POINT	=	00
ZERO	=	00-09bcd is a label of the frame number in the PMA unity
MIN, SEC, FRAME	=	Disc identification as a 6 BCD digit number.
PMIN	=	00
PSEC	=	Sessions format:
		00 – CD-DA or CD-ROM, 10 – CD-I, 20 – CD-ROM-XA
PFRAME	=	00

Mode-3 Q Sub-channel in the PMA is a Skip track item (optional, audio only):

TNO	=	00
POINT	=	01-21bcd is the mode-3 index of this item
ZERO	=	00-09bcd is a label of the frame number in the PMA unity
MIN	=	01-99bcd track number to skip upon playback
Each of the following:	=	00 if no skip track is specified
SEC, FRAME	=	01-99bcd (each byte) track number to skip upon playback
PMIN, PSEC, PFRAME		

Mode-4 Q Sub-channel in the PMA is an unskip track item (optional, audio only):

TNO	=	00
POINT	=	01-21bcd is the mode-4 index of this item
ZERO	=	00-09bcd is a label of the frame number in the PMA unity
MIN	=	01-99bcd track number to unskip upon playback
Each of the following:	=	00 if no unskip track is specified
SEC, FRAME	=	01-99bcd (each byte) track number to unskip upon playback
PMIN, PSEC, PFRAME		

Mode-5 Q Sub-channel in the PMA is a skip interval item:

TNO	=	00
POINT	=	01-40bcd is the mode-5 index of this item
ZERO	=	00-09bcd is a label of the frame number in the PMA unity
MIN, SEC, FRAME	=	Skip interval stop time in 6 BCD digits.
PMIN, PSEC, PFRAME	=	Skip interval start time in 6 BCD digits.

Mode-6 Q Sub-channel in the PMA is an “unskip interval” item:

TNO	=	00
POINT	=	01-40bcd is the mode-6 index of this item
ZERO	=	00-09bcd is a label of the frame number in the PMA unity
MIN, SEC, FRAME	=	Unskip interval stop time in 6 BCD digits.
PMIN, PSEC, PFRAME	=	Unskip interval start time in 6 BCD digits.

4.2.3.11 Recording

Blank CD-R is not randomly writable. CD-RW is limited in its random write capability. Due to the interleaved nature of CD frames, blank media shall be recorded in groups of frames with linkage for appending new recording.

There are two methods for linking separate writes on CD-R or CD-RW:

Audio – Linkage occurs within a single frame time. This assures that locating the linkage frame by its Q at a later time is nearly impossible.

Data – Since it is necessary to locate exact boundaries of user blocks, additional padding is inserted around the linkage frame. The collection of the link block, the pad blocks, and the user blocks is called a Packet. The format of the packet is shown in Figure 22.

Link Block	Run-in Block 1	Run-in Block 2	Run-in Block 3	Run-in Block 4	User Data Blocks	Run-out Block 1	Run-out Block 2
------------	----------------	----------------	----------------	----------------	------------------	-----------------	-----------------

Figure 22 — Packet Format

Bits 5, 6, and 7 of the block's mode byte (see Table 27) uniquely identify blocks.

Table 27 — Block Identifier bits

Mode Byte Bits 7, 6, 5	Block
000	User Data
001	Run-in block 4
010	Run-in block 3
011	Run-in block 2
100	Run-in block 1
101	Link block
110	Run-out block 2
111	Run-out block 1

See 4.2.3.8 for a detailed definition of the Mode Byte. Main channel user data should be all zeros.

Only entire packets may be rewritten on CD-RW media.

There are 2 types of recording on CD-R: Uninterrupted and Incremental. Incremental recording requires linking, whereas uninterrupted does not.

Disc At Once is the only type of uninterrupted recording and is a special case of Session At Once. The recording begins at the start of the Lead-in and stops only when the last block of the Lead-out is written. The PMA is not written. No linking is required.

There are 5 types of incremental recording:

Session At Once – The recording begins at the start of the Lead-in of the next session and stops only when the last block of that session's Lead-out is written. The PMA is constructed and written as a separate write action. Linking between sessions is required.

Reserve Track – User data is not necessarily written. The PMA is written for the purpose of defining a new track.

Track At Once – A single packet that includes the pre-gap of the track and all of the track's user data.

Variable Packet – A variable number of user blocks is written between data linkage blocks. A variable packet shall be a part of the user data area of a track.

Fixed Packet – A fixed number of user blocks is written between the user blocks. A fixed packet shall be a part of the user data area of a track.

4.2.3.12 The Track Descriptor Block

The Track Descriptor Block (TDB) is required for Track at Once or Packet recording. When the TDB is present, each block of the pre-gap of a track is a TDB. When a track is only reserved for Track At Once recording, recording of the TDB is deferred until the track data is written. When a track is reserved for either sort of packet recording, the TDB shall be written as a single packet upon reservation.

The TDB contains main channel information about the track recording and optionally contains a history of tracks that preceded the TDB.

The TDB begins with an 8-byte header (Table 28). The TDB header is followed by one or more Track Descriptor Units (TDU) (Table 29).

Table 28 — Track Descriptor Block (TDB) header

Bit Byte	7	6	5	4	3	2	1	0
0	54h (ASCII "T")							
1	44h (ASCII "D")							
2	49h (ASCII "I")							
3	Pre-gap Length encoded BCD							
4								
5	Reserved							Current
6	Lowest Track Number Listed (BCD)							
7	Highest Track Number Listed (BCD)							
8	One or more Track Descriptor Unit(s) (TDU)							
:								
n								

Pre-gap length is given in number of blocks.

The Current bit, when set to 1, indicates that only the TDU for the current track is present. When set to zero, indicates that a TDU for tracks with numbers smaller than or equal to the current track, are present.

Table 29 — Track Descriptor Unit (TDU) Format

Bit Byte	7	6	5	4	3	2	1	0
0	Track Number (BCD)							
1	Recording method							
2	Fixed Packet Size in blocks (BCD)							
3								
4								
5	Reserved							
...	Reserved							
15	Reserved							

Recording method is coded as shown in Table 30.

Table 30 — Recording Method

Code	Recording Method
00h	Audio track written TAO
80h	Data track written TAO
90h	incrementally written data track, variable packets
91h	incrementally written data track, fixed packets

Fixed Packet size is filled with FFFFFFFh whenever the recording method is not fixed packet.

4.2.4 High Speed CD-RW media recording

High speed CD-RW is defined in [CD-Ref10]. High Speed CD-RW recording speed ranges are from 4x to 24x recording and also allows CAV recording. Newer versions of this media (speeds greater than 10x) are referred to as Ultra-Speed CD-RW. Upon CAV recording, write speed needs to be set for each track. If the Drive is not capable of recording continuous track in CAV, then the Drive shall use CLV mode with initial speed of CAV recording. e.g., if the 4x-10x CAV recording is attempted for TAO mode, but the Drive does not support CAV for TAO mode, then the Drive shall choose 4x CLV recording for that track. This condition is not considered as an error.

It may not be possible to record High speed CD-RW media using Drives that comply with only Orange Book Part 3 volume 1. Upon a write attempt to the High speed CD-RW media using a Drive that is only compliant with [CD-Ref9], some Drives return CHECK CONDITION Status and set SK/ASC/ASCQ values to either ILLEGAL REQUEST/WRITE PROTECTED or MEDIUM ERROR/NO SEEK COMPLETE. The recommended SK/ASC/ASCQ values for this case are ILLEGAL REQUEST/CANNOT WRITE MEDIUM – INCOMPATIBLE FORMAT.

In order to minimize the impact to legacy CD-R/RW Drives and software, the SET CD SPEED Command been modified. SET STREAMING Command and GET CONFIGURATION command for CD-R/RW implementation are defined.

Command Sequence example:

Upon media insertion, Host issues READ TRACK INFORMATION Command to find the next writable address. The GET CONFIGURATION Command may be used to identify the Drive's capability for the mounted media.

Host then issues either SET CD SPEED Command or SET STREAMING Command for the track to be recorded. Also the Host sets an appropriate Write Parameters, and ready to write data.

4.3 DVD Model

4.3.1 General

4.3.1.1 Overview

The DVD Model is the description for the media types defined by the DVD Forum: DVD-ROM, DVD-RAM, DVD-R/-RW, and media types defined by the DVD+RW Alliance: DVD+R and DVD+RW. There are ECMA and ISO standards that describe the characteristics of most DVD media types.

Like CD Drives/Media there are multiple types of DVD Drives/Media:

- a) Read Only (DVD-ROM)
- b) Recordable (i.e., write-once) (DVD-R and DVD+R)
- c) Re-Writable (DVD-RAM, DVD-RW, and DVD+RW).

The capacities of these different media vary. Some of these media also have the possibility of one or two sides, and independently, one or two layers per side.

4.3.1.2 Spiral Structure

There are common properties among all of the DVD media types. In the simplest case (single-sided, single layer), the physical track structure is similar to CD: a continuous spiral.

DVD provides the ability to use two focus depths in order that two spirals may be accessed from one side of the media. Additionally, media may be produced that contains recording on both sides of the media.

There are up to 4 possibilities for physical track structure:

- a) Single sided, single layer
- b) Single sided, dual layer
- c) Two sided, single layer,
- d) Two sided, dual layer.

In all cases, a track is one layer on one side of the media.

There are two types of track path for dual layer discs, either parallel or opposite. When the path is parallel, each track has its own Lead-in and Lead-out. When the path is opposite, the tracks share a single lead-in and a single lead-out and each layer has a transition zone called the middle area.

4.3.1.3 ECC Blocks

4.3.1.3.1 General

When fully recorded, a DVD spiral consists of an uninterrupted sequence of ECC blocks. Each ECC block contains 16 sectors of 2 048 data bytes each. Sectors are numbered with a 24-bit address. Numbering is linear and integral, beginning with zero. Sector zero exists only for the purposes of definition. The general DVD ECC block is based upon DVD-ROM standards [ISO/IEC 16448:2002] and [ISO/IEC 16449:2002].

Unlike CD media, adjacent sectors of DVD media are not necessarily interleaved. An ECC block consists of 16 sectors with headers, EDC symbols, and ECC symbols. Individual sector data are interleaved in order to minimize the effects of large media flaws. However, adjacent ECC blocks are not interleaved.

In order to read and extract a single sector of data, the Drive shall read the ECC block containing the sector, apply error correction to the ECC block, and de-interleave prior to extracting the data from the selected sector.

4.3.1.3.2 The Structure of the Data Sector

A DVD data sector contains 2 064 bytes, containing 2 048 bytes of main data and 16 bytes of additional information.

The logical layout of a DVD data sector is shown in Figure 23.



Figure 23 — Logical Layout of a DVD Data Sector

ID is a field that identifies the sector

IED contains 2 bytes of redundancy as an error detection code (EDC) for the ID field.

RSV is reserved and shall be recorded with zeros.

MAIN DATA contains 2 048 information bytes.

EDC contains 4 bytes of redundancy as an error detection code (EDC) for the entire sector.

The ID field is viewed as a 32-bit field as shown in Figure 24.



Figure 24 — ID Field

Sector Information varies for different DVD media types.

The least significant 24 bits (bits 23 through 0) contain the Physical Sector Number (PSN). The PSN of the first Physical Sector of an ECC Block shall be an integral multiple of 16. In the data zone, the translation of LBA to PSN varies according to media.

4.3.1.3.3 The Structure of the ECC Block

A 2 064-byte sector is divided into 12 rows of 172 bytes each. Main data is scrambled similar to CD-ROM data scrambling. 16 sequential sectors are packed a single structure of 192 rows, each with 172 bytes. Error correction redundancy symbols are appended in order to produce 208 rows of 182 bytes each.

The organization of sector data and redundancy symbols within an ECC block is illustrated in Figure 25. Columnar symbols (Cx,y) are calculated and appended to rows, then Row symbols (Rx,y) are calculated and appended to columns. Columnar redundancy symbols are collectively known as Inner Parity (PI). Row redundancy symbols are collectively known as Outer Parity (PO).

		User Data					ECC Parity on Rows				
User Data		B0,0	B0,1	B0,2	...	B0,171	C0,0	C0,1	C0,2	C0,9
		B1,0	B1,1	B1,2	...	B1,171	C1,0	C1,1	C1,2	...	C1,9
		B2,0	B2,1	B2,2	...	B2,171	C2,0	C2,1	C2,2	...	C2,9
		B3,0	B3,1	B3,2	...	B3,171	C3,0	C3,1	C3,2	...	C3,9
	
		B190,0	B190,1	B190,2	...	B190,171	C190,0	C190,1	C190,2	...	C190,9
		B191,0	B191,1	B191,2	...	B191,171	C191,0	C191,1	C191,2	...	C191,9
ECC Parity		R0,0	R0,1	R0,2	...	R0,171	C192,0	C192,1	C192,2	...	C192,9
		R1,0	R1,1	R1,2	...	R1,171	C193,0	C193,1	C193,2	...	C193,9
		R2,0	R2,1	R2,2	...	R2,171	C194,0	C194,1	C194,2	...	C194,9
	
		R15,0	R15,1	R15,2	...	R15,171	C207,0	C207,1	C207,2	...	C207,9

Figure 25 — ECC Block Structure

Each of the 16 sectors of an ECC block has a unique PSN. The PSNs are sequential such that if the smallest is N, then N+1, N+2, N+3, ..., N+15 are also present in the ECC block. i.e., the sectors are sequenced in an intuitively correct way.

4.3.1.4 The Lead-in Area

The Lead-in Area has the general arrangement shown in Figure 26. Actual sizes and locations of each zone vary according to media type.

Lead-in Area	Initial Zone	Start of the spiral – zone of protection
	Area Specific to Media Type	Use varies according to media type
	Reference Code Zone	Read Calibration Area
	Buffer Zone 1	Separation Area
	Control Data Zone	Disc information - part of this is media specific
	Area Specific to Media Type	Use varies according to media type
Data Area	Data Zone	Viewed as user data area. Start PSN varies. Recordable media may implement a defect management.

Figure 26 — General Layout of Lead-in Area

For all DVD media types, the Control Data Zone consists of 192 ECC blocks. The first 2 sectors of each ECC block contains the same information. The structure of an ECC block within this zone is shown in Table 31.

Table 31 — Structure of Control Data ECC Block

Sector Number	Description
0	Physical Format Information
1	Disc Manufacturing Information
2	Content provider information
...	
...	
...	
14	
15	

The format of the Physical Format Information (sector 0 of a Control Data ECC Block) is shown in Table 32.

Table 32 — Physical Format Information

Bit	7	6	5	4	3	2	1	0
Byte								
0	Disk Category (Book Type)			Version Number (Part Version)				
1	Disk Size			Maximum Transfer Rate				
2	Reserved	Number of Layers		Track Path	Layer Type			
3	Linear Density			Track Density				
4	Data Area Allocation							
5								
...								
...								
...								
15								
16	BCA Flag	Reserved						
17-2047	Medium Unique Data							

Disk Category defines the source of the media specification. Disk Category codes are shown in Table 33.

Table 33 — Disk Category

Disk Category	Associated Media	Disk Category	Associated Media
0h	DVD-ROM	8h	Reserved
1h	DVD-RAM	9h	DVD+RW
2h	DVD-R	Ah	DVD+R
3h	DVD-RW	Bh	Reserved
4h	Reserved	Ch	Reserved
5h	Reserved	Dh	DVD+RW DL
6h	Reserved	Eh	DVD+R DL
7h	Reserved	Fh	Reserved

Version Number specifies the media version.

Note 2. Disk Category 2h (DVD-R) defines a category for both single layer and dual layer media. The media are distinguished by the Version Number.

Disk Size specifies the physical disc diameter as shown in Table 34.

Table 34 — Disk Size

Disk Size Code	Disc Diameter
0000b	12 centimeter
0001b	8 centimeter
0010b – 1111b	Reserved

Maximum Rate defines the maximum read data rate. Meaning of specific values is media dependent.

Number of Layers, Track Path, Layer Type, Linear Density, and Track Density specify media recording structure. See the appropriate media specification.

Data Area Allocation specifies bounds of the recorded/recordable area. This is specific to media type.

The BCA Flag identifies the presence/absence of a Burst Cutting Area.

Medium Unique Data contains data specific to the media type.

Disc Manufacturing Information (sector 1 of a Control Data ECC Block) is 2 048 bytes and has no standardized format.

4.3.2 DVD-ROM

4.3.2.1 Track Structure

DVD-ROM may have any of the 4 structures:

- a) single sided, single layer,
- b) single sided, dual layer,
- c) two sided, single layer,
- d) two sided, dual layer.

Two addresses are used: the Block address contained in the sector headers (Physical Sector Number), and the address used to reference the blocks from the Host system (LBA). The address used from the Host starts at 0 and progresses up through the end of the recorded information on the disc. LBA 0 shall correspond with the sector address of 030000h on DVD-ROM media. Only the Data Area is generally addressable using an LBA.

4.3.2.2 Sector Structure

DVD-ROM ECC block structure is consistent with the definition in 4.3.1.3. For DVD-ROM, the definition of the sector information part of the ID field is shown in Figure 27.

Sector Information ID bits 31 through 24							
31	30	29	28	27	26	25	24
Sector Format Type	Tracking Method	Reflectivity	Reserved	Zone Type		Data Type	Layer Number

Sector Format Type	0b	Indicates CLV format
Tracking Method	0b	Indicates pit tracking
Reflectivity	0b	Indicates reflectivity exceeds 40%
	1b	Indicates reflectivity is less than or equal to 40%
Reserved	0b	
Zone Type	00b	When sector is in Data Zone
	01b	When sector is in Lead-in Zone
	10b	When sector is in Lead-out Zone
	11b	When sector is in Middle Zone
Data Type	0b	Indicates read-only data
Layer Number	0b	When sector is in layer 0
	1b	When sector is in layer 1

Figure 27 — ID Field for DVD-ROM

4.3.2.3 The Lead-in

The DVD-ROM lead-in structure is consistent with the structure shown in Figure 26. Table 35 shows the lead-in structure specific to DVD-ROM.

Table 35 — DVD-ROM Lead-in Structure

Starting PSN	Disc Area
22FA0h	Initial Zone All 00h
2F000h	Reference Code Zone
2F020h	Buffer Zone 1 All 00h
2F200h	Control Data Zone (192 ECC Blocks)
2FE00h	Buffer Zone 2 All 00h
30000h	Data Area
.	
.	

DVD-ROM is consistent with the general structure of the Control Data ECC Block as shown in Table 31 and the Common Part of the Physical Format Information as shown in Table 32.

Table 36 shows the Data Allocation Area (relative to its position in the Physical Format Information) specific to DVD-ROM.

Table 36 — Data Area Allocation Definition

Byte	Single Layer/ Parallel Track Path	Opposite Track Path
4	00h	00h
5	Starting PSN of Data Area (030000h)	Starting PSN of Data Area (030000h)
6		
7		
8	00h	00h
9	End PSN of Data Area	End PSN of Data Area
10		
11		
12	00h	00h
13	000000h	End PSN in Layer 0
14		
15		

The Media Unique Data in the Physical Format area of the Control Data Zone is reserved and zero filled.

4.3.3 DVD-RAM

4.3.3.1 General

DVD-RAM is a single layer media that may be single sided or two sided. DVD-RAM is defined in both 80 mm (1.46 GB) and 120 mm (4.7 GB) discs.

4.3.3.2 Physical Track Structure

DVD-RAM media is divided into zones much like notching on magnetic disk drives. The first sector of each revolution in these Zones is always aligned. The data is recorded using a constant angular velocity within each Zone, thus the actual size of the "bits" within a zone increase from the beginning of a zone toward the end of the zone. This keeps the data rate constant for reading and writing within each Zone with constant rotational speed. Each Zone has a fixed radius in width and as such each contains a different number of sectors.

120mm DVD-RAM media is divided into 35 zones, where zone 0 has 25 sectors per revolution, and zone 34 has 59 sectors per revolution. 80mm DVD-RAM media is divided into 14 zones, where zone 0 has 25 sectors per revolution, and zone 13 has 38 sectors per revolution. See Figure 28.

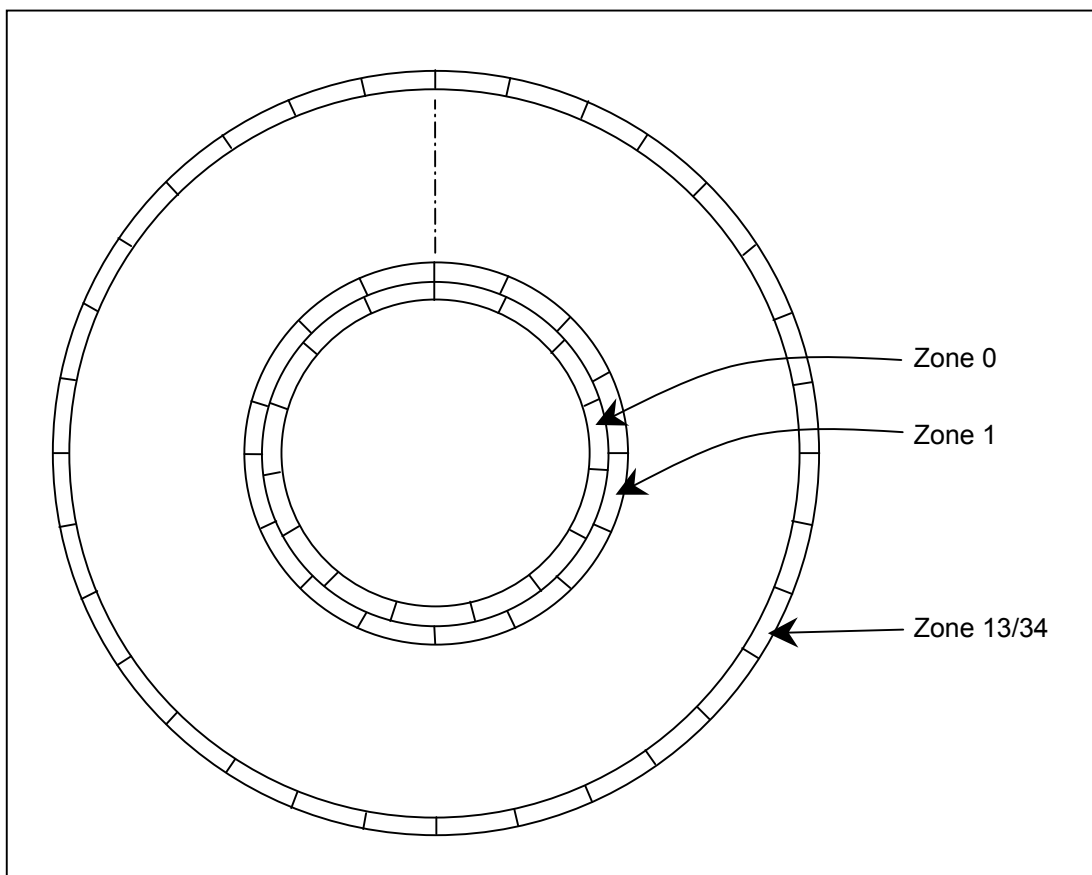

Figure 28 — Zoning of DVD-RAM media

4.3.3.3 Sector Structure

The basic DVD ECC block structure as defined in 4.3.1.3 applies to DVD-RAM. For DVD-RAM, the definition of the sector information part of the ID field differs from other DVD media types.

The sector ID field is viewed as a 32-bit field as shown in Figure 29.

Sector Information ID Bits 31 thru 24						
31	30	29	28	27	25	24
Sector Format Type	Tracking Method	Reflectivity	Recording Type	Zone Type	Data Type	Layer Number

Sector Format Type	0b	Indicates CLV format
Tracking Method	1b	Indicates groove tracking
Reflectivity	0b	Indicates reflectivity exceeds 40%
	1b	Indicates reflectivity is less than or equal to 40%
Recording Type	0b	Lead-in, Lead-out, General Data in Data Area
	1b	Real-time Data in Data Area
Zone Type	00b	When sector is in Data Zone
	01b	When sector is in Lead-in Zone
	10b	When sector is in Lead-out Zone
	11b	Reserved
Data Type	0b	Indicates embossed data
	1b	Indicates rewritable data
Layer Number	0b	DVD-RAM uses only layer 0

Figure 29 — ID Field for DVD-RAM

4.3.3.4 The Lead-in

The DVD-RAM lead-in structure is consistent with the structure shown in Figure 26. Table 37 shows the lead-in structure specific to DVD-RAM.

Table 37 — DVD-RAM Lead-in Structure

Starting PSN	Disc Area
22FA0h	Initial Zone All 00h
2F000h	Reference Code Zone
2F010h	Buffer Zone 1 All 00h
2F200h	Control Data Zone (192 ECC Blocks)
2FE00h	Buffer Zone 2 All 00h
30000h	Defect Controls
31000h	DATA AREA
.	
.	

DVD-RAM is consistent with the general structure of the Control Data ECC Block as shown in Table 31 and the Common Part of the Physical Format Information as shown in Table 32.

Table 38 shows the Data Allocation Area (relative to its position in the Physical Format Information) for DVD-RAM.

Table 38 — DVD-RAM Data Area Allocation Definition

Byte	DVD-RAM
4	00h
5	Starting PSN of Data Area (031000h)
6	
7	
8	
8	00h
9	End PSN of Data Area
10	
11	
12	00h
13	000000h
14	
15	

On DVD-RAM, all Control Data Zone ECC blocks are prerecorded with embossed data.

The Media Unique Data in the Physical Format area of the Control Data Zone is shown in Table 39.

Table 39 — DVD-RAM Unique Part of Physical Format Information

Bit	7	6	5	4	3	2	1	0
Byte								
32	Disc Type Identification							
33-499	Reserved							
500	Velocity							
501-548	Write conditions at Velocity							
549-596	Disc Manufacturer's name							
597-612	Disc Manufacturer's supplementary information							
613-623	Write Power Control Parameters							
624-699	Reserved							
700	3x Speed Velocity (Optional)							
701-757	Write Conditions at 3x Speed Velocity (Optional)							
758-2047	Reserved							

4.3.3.5 Logical Structure

The DVD-RAM Data Area begins at 031000h. This is caused by the existence of Defect Controls. There are two Defect Controls: one is located immediately before the Data Area and starts at 030000h, and the other is located immediately after the Data Area. The Defect Controls are non-user addressable areas. These blocks contain Defect Management Areas (DMAs).

The DMA contains Disc Definition Structure (DDS) for the recording method used for formatting of the disc, a Primary Defect List (PDL) for recording defective sectors identified at formatting of the disc, and a Secondary Defect List (SDL) for recording defective ECC blocks identified during writing/reading user data.

The Data Area has one or two Spare Areas. There are two types of Spare area, Primary Spare Area (PSA) and Supplementary Spare Area (SSA). The PSA is always pre-assigned at Initialization/Re-initialization. The SSA size is selectable at Initialization/Re-initialization and is expandable afterward. The User Area and Spare Areas contain user accessible sectors addressed by an LBA. The LBAs increase toward the Outer Diameter. Defective sectors are replaced by sectors in the Spare Area. The last LBA is 23051Fh in the case of 120mm and AE6EFh in the case of 80mm.

The location of Primary Spare Area is written in the DDS and the location of Supplementary Spare Area is written in the SDL.

The total number of sectors in the PSA is 12 800 on 120mm media and 5 120 on 80mm media. DVD-RAM has only one group. The total number of sectors in the SSA is selectable from 0 to 97 792 in the case of 120mm media and 89 088 in the case of 80mm media. A Guard Area is located at the boundary to prevent signal crosstalk between Zones. The LBA of first Sector in the Group is the case of no defects in the media.

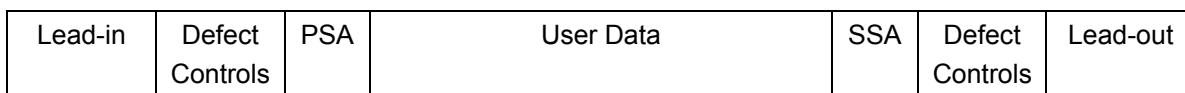

Figure 30 — DVD-RAM Logical Layout

4.3.3.6 DVD-RAM Recording

DVD-RAM is randomly writable in ECC block increments. Random writability in 2 048 byte sectors is accomplished by read-modify-write actions with ECC blocks. DVD-RAM implements defect management that provides for a seamless LBA space for the Host. Consequently, DVD-RAM implements the Removable Disk Profile.

4.3.4 DVD-R/-RW

4.3.4.1 Track Structure

DVD-R and DVD-RW are single track, single layer media. DVD-R/-RW is defined in both 80 mm (1.46 GB) and 120 mm (4.7 GB) discs.

4.3.4.2 Sector Structure

The basic DVD ECC block structure as defined in 4.3.1.3 applies to DVD-R/-RW. For DVD-R/-RW, the definition of the sector information part of the ID field differs from other DVD media types.

The sector ID field is viewed as a 32-bit field as shown in Figure 31.

Sector Information ID Bits 31 thru 24						
31	30	29	28	27	25	24
Sector Format Type	Tracking Method	Reflectivity	Reserved	Zone Type	Data Type	Layer Number

Sector Format Type	0b	Indicates CLV format
Tracking Method	1b	Indicates groove tracking
Reflectivity	0b	Indicates reflectivity exceeds 40% (DVD-R)
	1b	Indicates reflectivity is less than or equal to 40% (DVD-RW)
Reserved	0b	Reserved
Zone Type	00b	When sector is in Data Zone
	01b	When sector is in Lead-in Zone
	10b	When sector is in Lead-out Zone
	11b	Reserved
Data Type	0b	Indicates read-only data or rewritable data
	1b	Indicates sector is linking data
Layer Number	0b	Through the entrance surface only one recording layer may be accessed

Figure 31 — ID Field for DVD-R/-RW

4.3.4.3 The Lead-in

The DVD-R/-RW lead-in structure is consistent with the structure shown in Figure 26. Table 40 shows the lead-in structures specific to DVD-R and DVD-RW.

Table 40 — Lead-in Structure: DVD-RW and DVD-R

Starting PSN	Disc Area
22FA0h	Initial Zone All 00h
2E200h	Buffer Zone 0 (all 00h)
2E400h	Physical Format Information Zone
2F000h	Reference Code Zone
2F020h	Buffer Zone 1 All 00h
2F200h	Control Data Zone (192 ECC Blocks) (Pre-recorded area)
2FE00h	Extra Border Zone
30000h	DATA AREA
.	
.	

4.3.4.3.1 Control Data Zone

DVD-R/-RW is consistent with the general structure of the Control Data ECC Block as shown in Table 31 and the Common Part of the Physical Format Information as shown in Table 32.

Table 42 shows the Data Allocation Area (relative to its position in the Physical Format Information) for DVD-R/-RW.

Table 41 — DVD-R/-RW Data Area Allocation Definition

Byte	DVD-RW/DVD-R
4	00h
5	Starting PSN of Data Area (030000h)
6	
7	
8	00h
9	Last address of Data Recordable area
10	
11	
12	00h
13	000000h
14	
15	

The Media Unique Data in the Physical Format area of the Control Data Zone is shown in Table 42.

Table 42 — DVD-RW/-R for General Unique Part of Physical Format Information

Bit	7	6	5	4	3	2	1	0
Byte								
32 - 35	Start PSN of the Extra Border Zone (= 02FE10h)							
36 - 39	Start PSN of Physical Format Information blocks in Extra Border Zone (= 02FFA0h)							
40 - 2 047	Reserved							

4.3.4.3.2 DVD-R/-RW Physical Format Information Zone

The R/RW-Physical Format Information Zone is defined only for DVD-RW and DVD-R media. The R/RW-Physical Format Information Zone contains 192 ECC blocks. DVD-R/-RW Physical Format Information consists of 16 sectors and is repeated 192 times.

The structure of R/RW-Physical Format Information is shown in Table 43.

Table 43 — DVD-R/-RW Physical Format Information Zone

Sector Number	Description
0	Reserved
1	Manufacturing Information
2	Physical Format Information
3	Reserved
:	
15	

The contents of the Physical Format Information in DVD-R/-RW Physical Format Information Zone is same as the contents of Physical Format Information in Control Data Zone except Data Area Allocation field and unique part of Physical Format Information (byte 32 – byte 2 047).

The definition of the Data Area Allocation field in DVD-R/-RW Physical Format Information is shown in Table 44.

Table 44 — Data Area Allocation Field in DVD-R/-RW Physical Format Information

Byte	Disc at Once	Incremental Write/Restricted Overwrite
4	00h	00h
5	Starting PSN of Data Area (030000h)	Starting PSN of Data Area (030000h)
6		
7		
8	00h	00h
9	End PSN of Data area	Last Recorded Sector Number of the last Track in the Session ¹
10		
11		
12	00h	00h
13	000000h	000000h
14		
15		

¹When the Lead-in or Border-in is recorded in the Restricted Overwrite mode, and when the last session is in an Intermediate state, this field shall be set to 30000h.

The definition of the Unique Part of Physical Format Information fields in DVD-R/-RW Physical Format Information Zone is shown in Table 45. When the Lead-in is recorded in the Disc at once recording mode, this field contains all 00h data.

Table 45 — Unique Part of Physical Format Information in DVD-R/-RW Physical Format Information

Bit	7	6	5	4	3	2	1	0
Byte								
32 – 35	Start PSN of the current Border-out							
36 – 39	Start PSN of the next Border-in							
40 –2047	Reserved							

4.3.4.3.3 Extra Border Zone

The Extra Border Zone is defined for DVD-RW and DVD-R media.

The structure of Extra Border Zone is shown in Figure 32.

The structure of Extra Border Zone is similar to Border Zone. However, the length of Extra Border Zone is only 32 ECC blocks and there are no Next Border Markers and Stop Blocks.

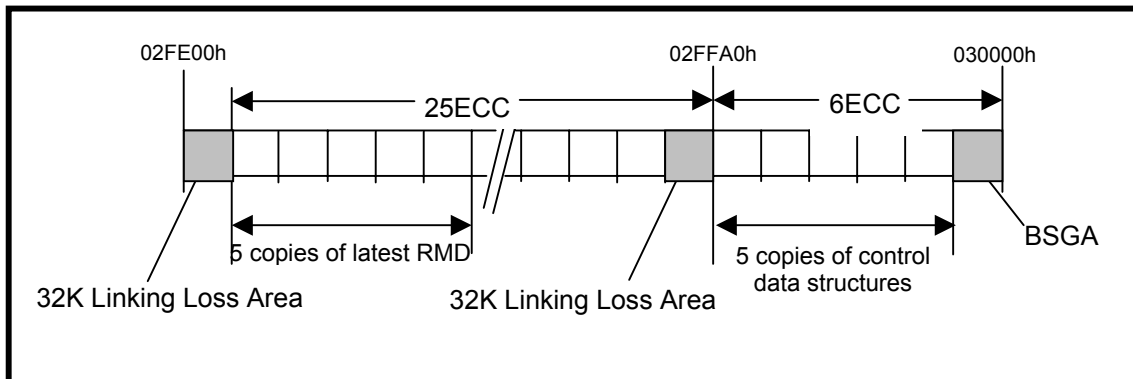

Figure 32 — Structure of Extra Border Zone

4.3.4.4 DVD-R/-RW Recording

4.3.4.4.1 RZone Description

The DVD-R/-RW specifications describe a logical entity called RZone.

- Two RZones are separated by one ECC block that is zero filled called the Block Sync Guard Area (BSGA) to assure a consistent link loss.
- The RZone begins at the LBA of the first sector of user data after a BSGA.
- An RZone ends at an ECC block boundary, so the last ECC block may contain 0 to 15 sectors that do not contain user data. When considering the RZone length, those sectors are considered part of the RZone. When the RZone is recorded incrementally, there may more link loss areas. When considering the RZone length, the link loss is part of the RZone. The length of an RZone is always a multiple of 16 and includes a BSGA except for the RZone that precedes the lead-out.
- The maximum number of RZones is 2 302.

4.3.4.4.2 Border-in/Border-out

The DVD-R/-RW specifications describe entities called Lead-in, Lead-out, Border-in and Border-out. DVD-R/-RW always have zero or one Lead-in and zero or one Lead-out. The Lead-in, if recorded, is always at the beginning of the disc and the Lead-out, if recorded, is always at the end of the disc. No data may be recorded beyond the Lead-out. The information recording area is a sequence of Lead-in/Border-in, Bordered Areas, and Border-out. This area, when written, is called a complete session.

If intermediate interchangeability is desired before recording the Lead-out, a Border-out is written in its place. When additional recording is to be done, a Border-in is recorded between the last Border-out and the new data.

If only a Border-in and Border-out are to be written (after incrementally recording data), the Host should set the Multi-session field of the Write Parameters Mode Page to 11b. If set to 11b, and insufficient space exists on the medium for another Border, the Drive shall permanently close the medium by recording a Lead-out. If it is desired to permanently close a disc, the Multi-session field is set to 00b. The Multi-session field is ignored on DVD-R/-RW when the Write Type is set to Session at Once, and no next Border is possible. Within this standard, Multi-session is used instead of Multi-Border, incomplete session is used instead of incomplete Border, complete session is used instead of complete Border for DVD-R/-RW Drives.

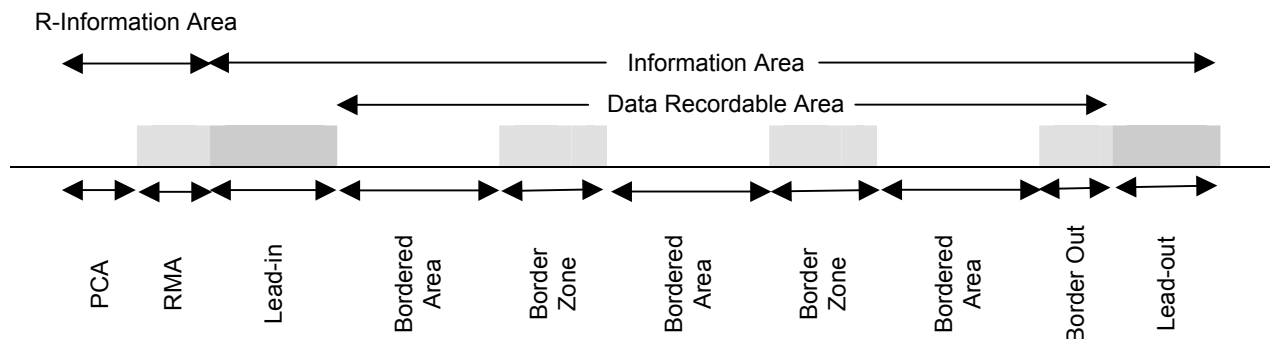

Figure 33 — Border Zone and Bordered Area

4.3.4.4.3 RMD Caching for RMA Updates

The RMA is the Recording Management Area for DVD-R/-RW media. The RMA is in the disc lead-in. The Recording Management Data (RMD) contains descriptions of all defined RZones and Borders. The RMD is typically cached in order to avoid exhaustion of the RMA by too many updates. To Update the RMA means to update the RMD on the disc or to update the RMD Cache which will be written into the RMA on the disc prior to the removing the disc from the Drive. RMD Caching is vendor specific.

Search for more pictures in fuji.

4.3.5 DVD-R Dual Layer

4.3.5.1 Introduction

The DVD-R Dual Layer (DVD-R DL) medium is DVD-R medium with two recording layers on a single side that enable recording the same capacity as DVD-ROM Dual Layer medium. DVD-R DL is constructed to be recorded only as an OTP disc. When a disc/Border is closed for interchange, the disc is readable by DVD players and DVD read-only Drives.

Table 46 shows the general parameters of DVD-R DL.

Table 46 — DVD-R media parameters

DVD-R spec Version Characteristics	2.1 for General (Single Layer)	3.0 (Dual Layer)
Capacity per side (12 cm)	4.7 gbytes	8.54 gbytes
Channel bit length (μm)	0.133	0.147
Track pitch (μm)	0.74	0.74
Number of Layers per side	1	2
Reflectivity	45 - 85 %	16 - 27 %
Control Data Zone	pre-recorded/embossed	
Maximum Number of NAWs	3	4
Standard recording speed	1x/2x	2x

Specific format requirements are detailed in [DVD-Ref5] (DVD-R Dual Layer Ver. 3.0 disc specification).

4.3.5.2 Physical Overview

In contrast to DVD-ROM Dual Layer medium, the DVD-R Dual Layer medium is constructed to be recorded only as an OTP disc.

The area on L1 should be recorded through the recorded area on L0 due to the characteristics of recording material. If the recording order is not kept, the uniformity of the recorded signal on L1 may not be good due to different transmissivity between recorded area and unrecorded area on L0.

To record L1 through the recorded area on L0, the L1 area size is manufactured with a smaller size compared to L0 by considering several physical factors (e.g., radial run-out, laser beam profile). See Figure 34.

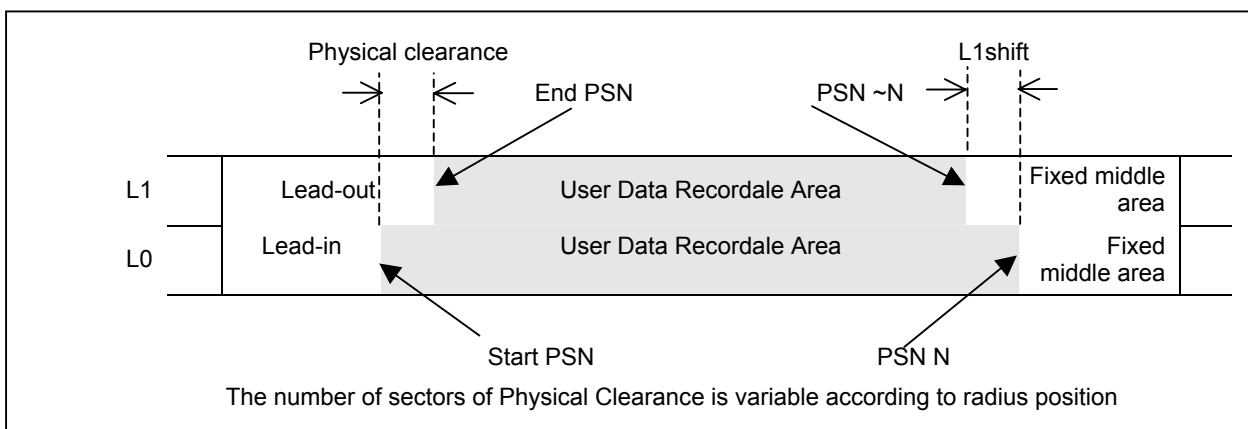

Figure 34 — Physical Overview of Layers

4.3.5.3 Logical Overview

The sector format and Control Data Zone format of DVD-R Dual Layer is same as that of DVD-ROM Dual Layer medium. The Control Data Zone is pre-recorded or embossed by disc manufacturer. Therefore the logical volume space size is fixed and not changeable. An LBA in the logical volume space has one-to-one relationship with a PSN (i.e., LBA = PSN-30000h).

The basic DVD ECC block structure as defined in 4.3.1.3 applies to DVD-R DL. The sector ID field is viewed as a 32-bit field as shown in Figure 24. For DVD-R DL, the definition of the sector information part of the ID field (Figure 35) differs from other DVD media types.

Sector Information ID Bits 31 thru 24						
31	30	29	28	27	25	24
Sector Format Type	Tracking Method	Reflectivity	Reserved	Zone Type	Data Type	Layer Number

Sector Format Type	0b	Indicates CLV format
Tracking Method	1b	Indicates groove tracking
Reflectivity	1b	Indicates reflectivity is less than or equal to 40%
Reserved	0b	Reserved
Zone Type	00b	When sector is in Data Zone
	01b	When sector is in Lead-in Zone
	10b	When sector is in Lead-out Zone
	11b	When sector is in Middle Zone
Data Type	0b	Indicates read-only data or rewritable data
	1b	Indicates sector is linking data
Layer Number	0b	When the sector is on layer 0
	1b	When the sector is on layer 1

Figure 35 — DVD-R DL ID Field Details

4.3.5.4 Recording on DVD-R Dual Layer

Three kinds of sequential recording modes are defined for DVD-R Dual Layer media. They are Disc-at-Once recording, Incremental recording and Layer Jump recording modes. The multi-Border recording is supported by the Layer Jump recording mode only.

Once a recording mode is determined on a medium, the recording mode is not changeable afterwards. The LJRS field of the READ TRACK INFORMATION command reports the recording mode information of the medium.

The associated Profile and Features for each recording mode is shown in Table 47.

Table 47 — Profile, Feature and Write Type value for each recording mode

Recording mode	Profile	Feature	Write Type value in Write Parameters Mode page
Disc-at-Once	Profile 0015h: DVD-R Dual Layer Sequential recording	Feature 002Fh: DVD-R/-RW Write Feature	02h (Disc-at-once)
Incremental		Feature 0021h: Incremental Streaming Writable Feature	00h (Incremental)
Layer Jump	Profile 0016h: DVD-R Dual Layer Jump recording	Feature 0033h: Layer Jump recording Feature	04h (Layer Jump)

4.3.5.4.1 RZone (Logical Track)

The definition of RZone for DAO and Incremental recording modes on DVD-R Dual Layer is identical to the definition of RZone on DVD-R Single Layer. The definition of RZone for Layer Jump recording mode is different from the others.

The RZone structure for Layer Jump recording is illustrated in Figure 36. The RZone **may** be written sequentially from the inner side of the L0 part through the end of the L1 part of the RZone via the Layer Jump Address.

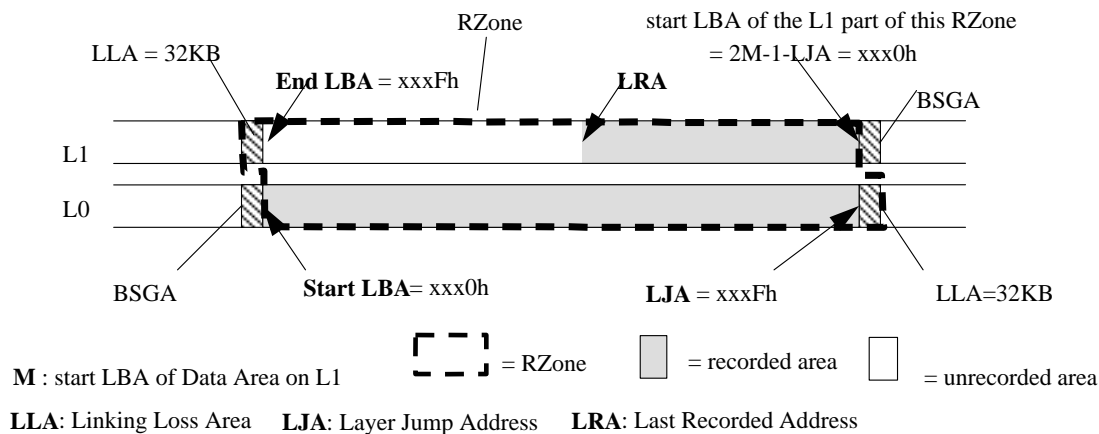
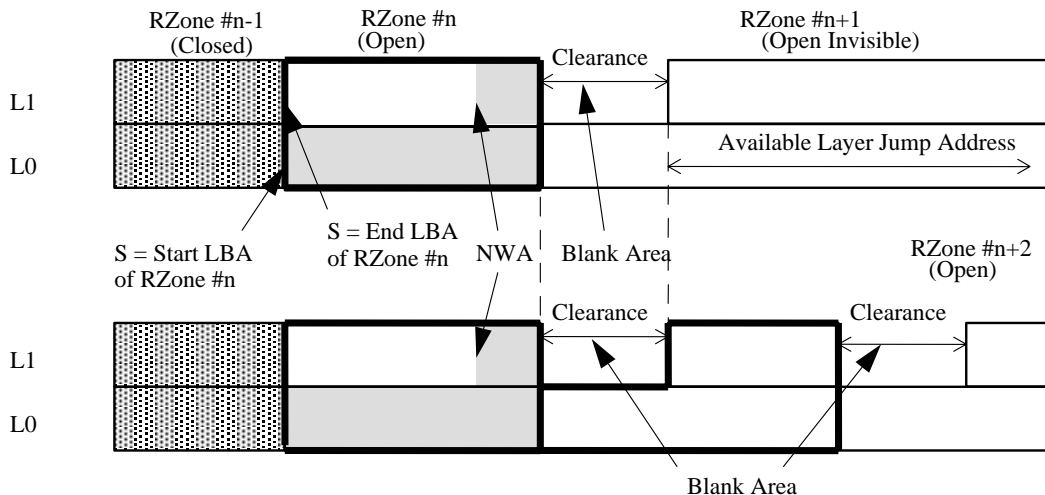

Figure 36 — RZone structure for Layer Jump recording

4.3.5.4.2 RZone Reservation

In Layer Jump recording mode, when an RZone is reserved, the Host is able to recognize the geometric parameters of the Reserved RZone by using the READ TRACK INFORMATION command (the Track/RZone Start Address field, the Next Layer Jump Address field or the Last Layer Jump Address field, the Last Recorded Address field and the Track/RZone Size / RZone End Address field).

When a new Invisible RZone is generated without closing the previous Reserved RZone, an unusable area is allocated at the inner side of the Invisible RZone on L1 to maintain the correct recording order between L0 and L1. This unusable area is referred to as Blank Area. The Blank Area will never be usable to record user data even if the previous RZone will become closed status.



Start LBA and End LBA of RZone #n+1 are not changed if it has L1 part.

Figure 37 — Blank Areas and RZone Shape

4.3.5.4.3 Border Zone

On DVD-R Dual Layer media, the Border Zone is defined only for the Layer Jump recording mode. The purpose of the Border Zone is to provide read compatibility for DVD read-only Drives.

The Border Zone is constructed with the symmetrical part of L0 and L1 as shown in Figure 38. The L0 part of the Border Zone has the same structure as the Border Zone on Single Layer DVD-R disc. The L1 part of the Border Zone is referred to as a Superficial Border-out and Superficial Border-in. They are used to store the back-up copies of remapping data.

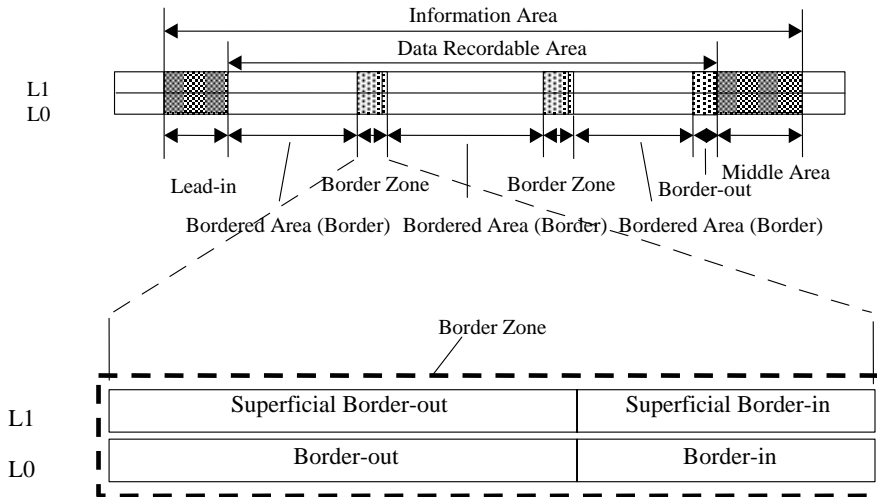

Figure 38 — Border Zone Structure for DVD-R Dual Layer media

4.3.5.5 Layer Jump recording

Layer Jump recording is a recording method defined for DVD-R Dual Layer discs. Layer Jump recording allows to set the Layer Jump Address to record both Layers alternately. The symmetrical L1 part is recorded only after the portion of L0 is recorded. This allows quick closing of the disc with Border Zone for DVD read-only Drive compatibility. Data is appendable after the closed border. The Layer Jump recording uses Format 4 RMD. To specify Layer Jump recording mode, the Write Type field of Write Parameters Mode Page shall be set to 04h (= Layer Jump recording).

An example sequence of Layer Jump recording is illustrated in Figure 39.

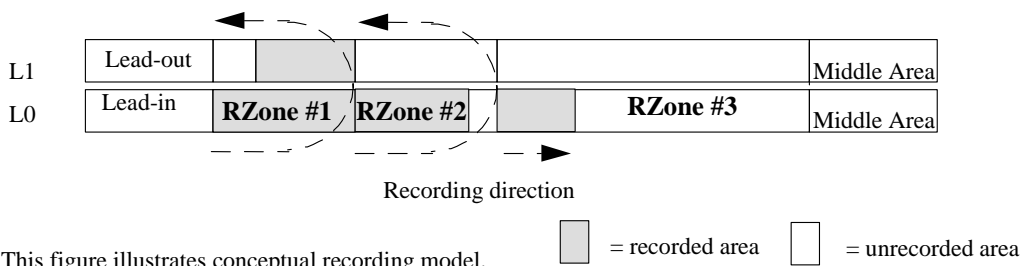

Figure 39 — Example of Layer Jump Recording

4.3.5.5.1 Layer Jump Block (LJB)

In Layer Jump recording mode, a the Host may use Reserved RZones to manage the layer jump locations when using Layer jump recording. A different mechanism is needed when recording in the Invisible/Incomplete RZone.

The Layer Jump Block (LJB) is defined to manage the recording sequence of the Layer Jump recording in a subdivision of the Invisible/Incomplete RZone. The LJB size on L1 is specified by setting the Layer Jump address (Manual Layer Jump recording) or setting the Jump Interval size (Regular Interval Layer Jump recording). When the Jump Interval size is set by the SEND DISC STRUCTURE command with Format Code = 22h, the LJB size on L1 is constant during the Regular Interval Layer Jump recording.

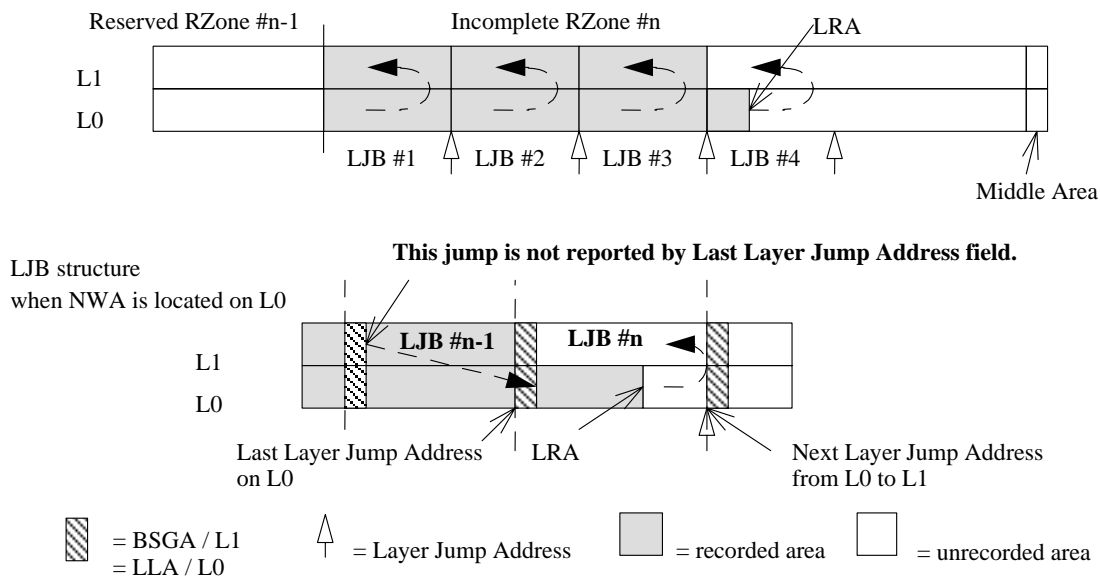

Figure 40 — LJB Structure of Invisible/Incomplete RZone

4.3.5.5.2 Layer Jump Methods

The Drive uses either Manual Layer Jump method or the Regular Interval Layer Jump method for the Invisible RZone. Once a method is determined, it cannot be changed until after the current Border is closed. The Regular Interval Layer Jump method may be selected by the Host only when the Invisible RZone is blank.

4.3.5.5.3 Manual Layer Jump

The Manual Layer Jump method is specified by using the SEND DISC STRUCTURE command with Format Code = 23h to specify the Manual Layer Jump Address on L0 to create a writing address on L1 of Invisible/Incomplete RZone. Only one Layer Jump Address **exists on the** Incomplete/Invisible RZone at any given time.

When the start address of the Shifted Middle Area is specified by the SEND DISC STRUCTURE command with Format Code = 21h at a lower address than the Manual Layer Jump Address specified by the SEND DISC STRUCTURE command with Format Code = 23h, the Manual Layer Jump Address becomes invalid.

When NWA reaches the Layer Jump Address on L0, NWA moves from L0 to L1. When all recordable blocks on L1 of the current LJB are recorded, the NWA moves from L1 to the next LJB on L0. The NWA is discontinuous at the Layer Jump Address.

The Manual Layer Jump Address is reported by the READ DISC STRUCTURE command with Format Code = 23h until the Layer Jump occurs at the specified address. The Next Layer Jump Address field of READ TRACK INFORMATION command shall report the same address if the Manual Layer Jump Address is the address where the next Layer Jump occurs. When no Layer Jump Address is specified by the SEND DISC STRUCTURE command with Format Code = 23h and the NWA of Invisible/Incomplete RZone is located on L0, the Next Layer Jump Address field reports Fixed or Shifted Middle Area start address -1 on L0. When Layer Jump from L0 to L1 has happened at Manual Layer Jump Address, the next Manual Layer Jump Address **may be** specified. And the Next Layer Jump Address field reports Layer Jump Address on L1.

Recording may be completed by repeating this Layer Jump operation. When a Layer Jump Address is specified, RMD is updated to register the Layer Jump Address when the LRA is located on L0.

4.3.5.5.4 Regular Interval Layer Jump

Regular Interval Layer Jump method **may** be specified only for the Invisible RZone and only when no Manual Layer Jump Address is specified. When the last RZone has the Invisible state, the Jump Interval size on L1 can be specified for the RZone by the SEND DISC STRUCTURE command with Format Code = 22h. The Jump Interval size does not contain Linking blocks such as BSGA. The Jump Interval size of Incomplete RZone is not changeable until Incomplete RZone is closed.

The case when there is a Clearance followed by the Invisible RZone:

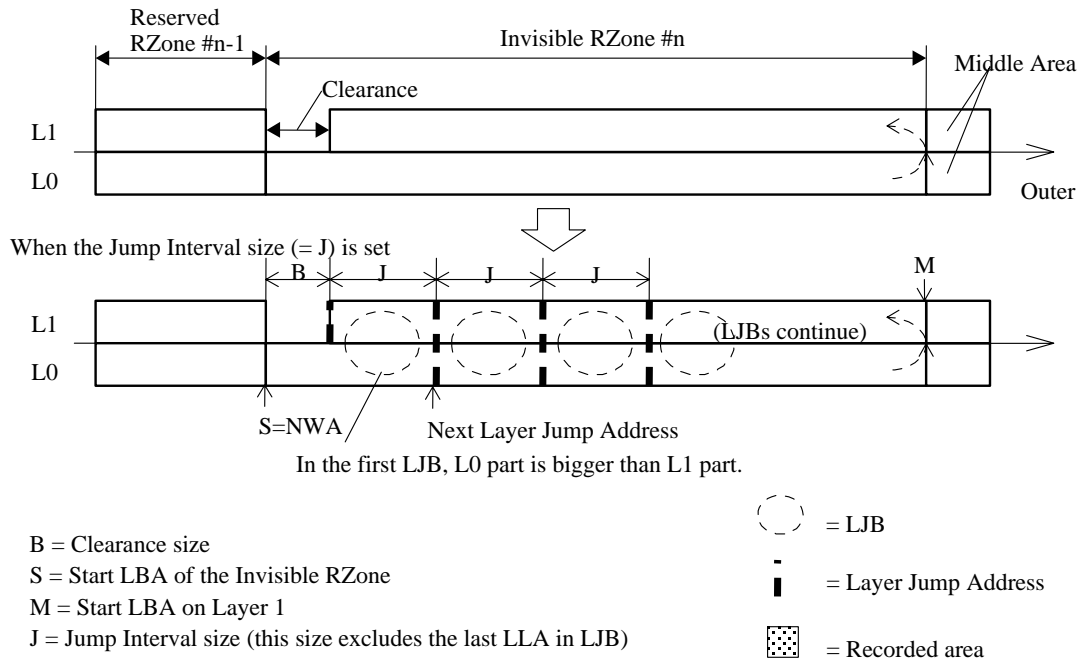

Figure 41 — Regular Interval Layer Jump

4.3.5.5 Remapping on Layer Jump recording

The address remapping mechanism works only when the disc is in Layer Jump recording mode. The address remapping mechanism is provided to permit the UDF and ISO-9660 file systems to adapt to Layer Jump recording on DVD-R Dual Layer disc. The remapping mechanism allows reading of the multi-Border recorded DVD-R Dual Layer disc as if it is single Border recorded disc.

Up to four predefined locations, called Anchor Points, **may** be remapped to alternative sectors by a host. The Anchor point addresses are specified by DVD-R Dual Layer Physical specification as shown in Table 48.

Table 48 — Predefined Anchor points

Anchor point	
AP1	PSN30010h (LBA 16)
AP2	PSN 30100h (LBA 256)
AP3	Maximum Last Recorded Address - 256 on L1
AP4	Maximum Last Recorded Address on L1

The SEND DISC STRUCTURE command, format = 24h, is used to set a remap address. The READ DISC STRUCTURE command, format = 24h, is used to read the remapped addresses.

The remapping is done in ECC block units. Therefore ECC blocks that contain Anchor points are remapped. The remapping status and address redirect information is stored in both RMD and Superficial Border-in and the

copies of remapped ECC blocks are stored in the Superficial Border-in/out. This enables DVD-ROM Drives to read remapped DVD-R Dual Layer disc.

4.3.5.6 RZone closing

Unrecorded blocks of an RZone shall be padded by the Drive when the RZone is closed. The Blank Area between Complete RZone and the RZone to be closed may be padded during the RZone closing operation.

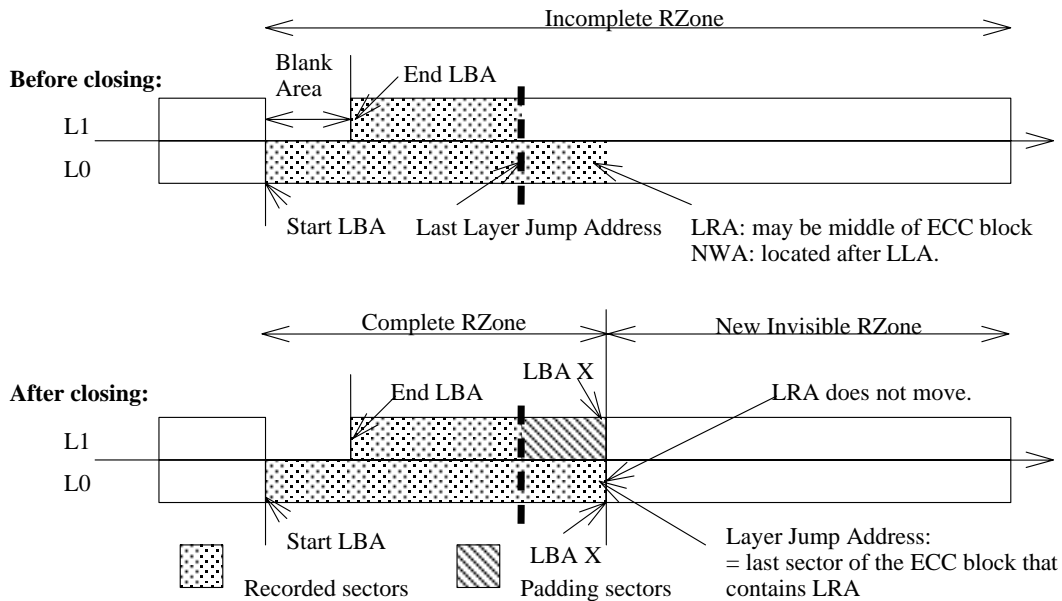

The PSN corresponding to LBA X is inverted address of the PSN that is corresponding to LBA X on L0.

Figure 42 — Incomplete RZone closing when NWA is on L0

4.3.5.7 Disc closing

In Layer Jump recording mode, when the disc is closed to prohibit further recording (= disc final closure), the Shifted Middle Area or Fixed Middle Area is recorded at the end of the user data. No additional recording is allowed beyond the any Middle Area. When the Shifted Middle Area is recorded, the Information Area shall be recorded more than 70 mm in diameter. If the recorded length is less than 70mm in diameter, the Drive shall write Shifted Middle Area up to 70 mm in diameter.

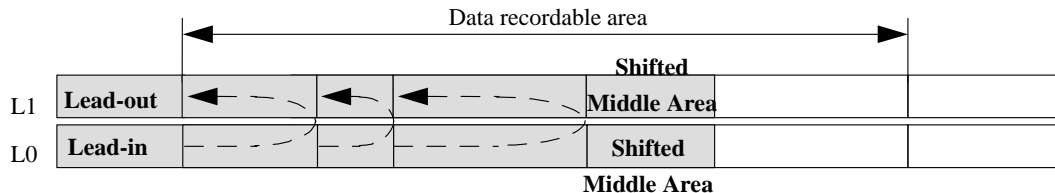

Figure 43 — Disc Final Closure in Layer Jump Recording Mode

4.3.5.8 State of DVD-R Dual Layer disc for ROM compatibility

In general, to make the recorded user data on DVD-R disc physically readable by DVD read-only Drives, at least the following three conditions must be satisfied to prevent the typical DVD read-only Drive optical pickup from overrunning to the unrecorded area due to the tracking servo mechanism:

- a) at the inner end of the recorded user Data Area, buffer zone such as Lead-in is located,
- b) at the outer end of the recorded user Data Area, buffer zone such as Border Zone or Middle Area is located,
- c) all the sectors from the beginning of the inner buffer zone to the end of the outer buffer zone are recorded.

In addition to the conditions above, in case of DVD-R Dual Layer disc, Lead-out and all the sectors on L1 located at the range between the inner part of Lead-in and the outer part of Border Zone/Middle Area on L0 must also be recorded.

4.3.6 DVD+R

4.3.6.1 Track Structure

DVD+R media is either 8 or 12 centimeters in diameter and separated into zones as shown in Figure 2. The Information zone is organized as a sequence of independently recorded units called ECC blocks. Each ECC block contains 16 user sectors. Each sector is identified by its PSN and contains 2 048 bytes of data.

Physical addresses advance incrementally beginning at the virtual address 00000000h. It is virtual, because the physical nature of a DVD+R device guarantees that no Drive is ever be able to reach the sector with PSN = 0. Similarly, the media is made with a zone of protection in the groove. Consequently, the first sector that is required to exist has a PSN significantly larger than 0. As with DVD-ROM, the first user accessible sector has PSN = 30000h. The DVD+R 120-mm one-sided disc has 4,70 GB available to the user, while the two-sided disc has 9,40 GB. The DVD+R 80-mm one-sided disc has 1,46 GB available to the user, while the two-sided disc has 2,92 GB.

4.3.6.1.1 The ADIP (Address in Pre-groove)

Like CD-RW media:

- DVD+R media has a wobble structure that defines the groove
- Information is modulated onto the wobble
- Within the Information Zone, this information contains the address of the associated sector
- Within the lead-in, there is additional information about the disc

This is generally called Address-In-Pre-groove or ADIP.

4.3.6.1.2 The ECC Block

The basic DVD ECC block structure as defined in 4.3.1.3 applies to DVD+R. The sector ID field is viewed as a 32-bit field as shown in Figure 24. For DVD+R, the definition of the sector information part of the ID field (Figure 44) differs from other DVD media types.

Sector Information ID Bits 31 thru 24						
31	30	29	28	27	25	24
Sector Format Type	Tracking Method	Reflectivity	Reserved	Zone Type	Data Type	Layer Number

Sector Format Type	0b	Indicates CLV format
Tracking Method	0b	Indicates pit tracking
Reflectivity	0b	Indicates reflectivity exceeds 40%
	1b	Indicates reflectivity is less than or equal to 40%
Reserved	0b	Reserved
Zone Type	00b	When sector is in Data Zone
	01b	When sector is in Lead-in Zone
	10b	When sector is in Lead-out Zone
	11b	Reserved
Data Type	0b	Indicates read-only data
Layer Number	0b	Through the entrance surface only one recording layer may be accessed

Figure 44 — DVD+R ID Field Details

4.3.6.1.3 DVD+R Groove Layout

The groove, when recorded, is a continuous sequence of ECC blocks. If ECC block E and E+1 are consecutive, then whenever N is the largest PSN in E, then N+1 is the smallest address in E+1. i.e., the ECC blocks are sequenced in an intuitively correct way.

The rest of logical groove architecture is given by specific use of individual sectors.

The DVD+R format provides only a continuous address space with no possibility of defect management.

Table 49 shows the zoned layout of the DVD+R groove. The Data Zone boundaries are based upon a single session recording.

Table 49 — DVD+R Format Lay-out

Disc Area	Zone
INNER DRIVE AREA	Initial Zone
	Inner Disc Test Zone
	Count Zone Run-in
	Inner Disc Count Zone
	Inner Disc Administration Zone
	Table of Contents Zone
LEAD-IN	Guard Zone 1
	Reserved Zone 1
	Reserved Zone 2
	Inner Disc Identification Zone
	Reserved Zone 3
	Reference Code Zone
	Buffer Zone 1
	Control Data Zone
	Buffer Zone 2
DATA	Data Zone
LEAD-OUT	Buffer Zone 3
	Outer Disc Identification Zone
	Guard Zone 2
OUTER DRIVE AREA	Outer Disc Administration Zone
	Outer Disc Count Zone
	Outer Disc Test Zone
	Guard Zone 3

4.3.6.2 Recording on DVD+R

4.3.6.2.1 Recording Structures

4.3.6.2.1.1 ECC Blocks

The minimal writable entity on DVD+R is the 32 KB ECC block. Physically, DVD+R is randomly writable in 32 KB ECC blocks, but not necessarily randomly readable. An ECC block is not fully decodable when it follows a blank area of media. In order to ensure readability, ECC blocks shall be written in sequential regions.

4.3.6.2.1.2 Fragments

A fragment is a set of contiguous ECC blocks in the Data Area that contains at least one ECC block. Fragments are distinct. i.e., given two different fragments, there are no ECC blocks in common. A fragment is the only unit of allocation on DVD+R. A recorded DVD+R disc shall contain at least one fragment.

Fragments are uniquely numbered beginning with one. The start address of fragment one is LBA 0. Fragments are numbered sequentially with no gaps. i.e., if fragment N and fragment M are different fragments and there are no fragments between fragment N and fragment M, then $M = N + 1$.

Fragment Oriented Definitions:

Reserved Fragment – Fragment allocation may be explicit, where both the start address and end address are specified. This is a reserved fragment.

The Incomplete Fragment – Fragment allocation may also be implicit, where the start address of the fragment is specified, but the end address is limited only by disc capacity. This is the incomplete fragment. The incomplete fragment may be transformed into two fragments: a reserved fragment and a new incomplete fragment.

Closed Fragment – If every ECC block within a reserved fragment is written, the fragment is closed.

Next Writable Address – Fragments shall be written sequentially, beginning with the start address of the fragment. This maintains the fragment in two parts: the written part that begins at the fragment start address and the blank part that begins with the first ECC block in the fragment that has not been written. The LBA of the first sector of the blank part is the Next Writable Address (NWA) of the fragment.

The Host may write using a 2 048-byte block size. The Drive shall buffer sequentially written data and write only when:

1. An ECC block amount of data has been received from the Host,
2. The Host issues a SYNCHRONIZE CACHE command,
3. The Host issues a CLOSE TRACK command, or
4. A new WRITE command is received for the NWA of a different fragment.

In cases 2 through 4, remaining user data in the ECC block shall be zero filled by the Drive prior to writing the ECC block. If no data is buffered for a partial ECC block, then cases 2 through 4 shall cause no write to occur.

4.3.6.2.1.3 Sessions

The data area of a DVD+R disc may be recorded in sessions similar to session recording in CD-R. Each session contains a lead-in equivalent area called the session “Intro”, a data area equivalent called session “user data”, and a lead-out equivalent called the session “closure”. The Intro of the first session is contained within the disc lead-in and the Closure of the final session is contained within the disc lead-out. Each Intro that is not in the disc lead-in is encoded as data. Each Closure that is not contained within the disc lead-out is encoded as data.

Sessions are uniquely numbered beginning with one. The start address of the user data of session one is LBA 0. Sessions are numbered sequentially with no gaps. i.e., if session N and session M are different sessions and there are no sessions between session N and session M, then $M = N + 1$.

Figure 45 shows an example of a multi-session layout on a DVD+R disc. Session 2 is called an interior session.

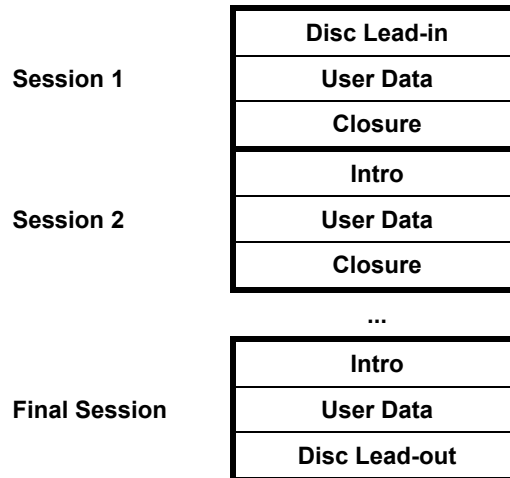

Figure 45 — General Layout of a Multi-Session DVD+R

The user data zone of a session is made up of a collection fragments. The user data zone contains at least one fragment and may contain up to 16 fragments.

Session Oriented Definitions:

Empty (Blank) Session – If no ECC block in a session is written, the session is blank.

Closed Session – If every ECC block within the session is written, the session is closed.

Open Session – If a session is not closed, then the session is open. An empty session is open.

Open (Incomplete, or Appendable) Disc – If a disc has an open session, then the disc is open.

Closed Disc – During the process of closing a session, the Host may specify that no new sessions are allowed. The last session is called the Final session and once that session is closed, the disc is closed. No new writing is allowed on a closed disc.

Run-in Block – A single ECC block, zero filled and written, shall separate two adjacent fragments within a session. This “run-in block” ensures that the first ECC block of the second fragment of a session is readable.

The status of a session and of the fragments within its user data zone is found within the session’s Intro. Figure 46 shows the zones of a session.

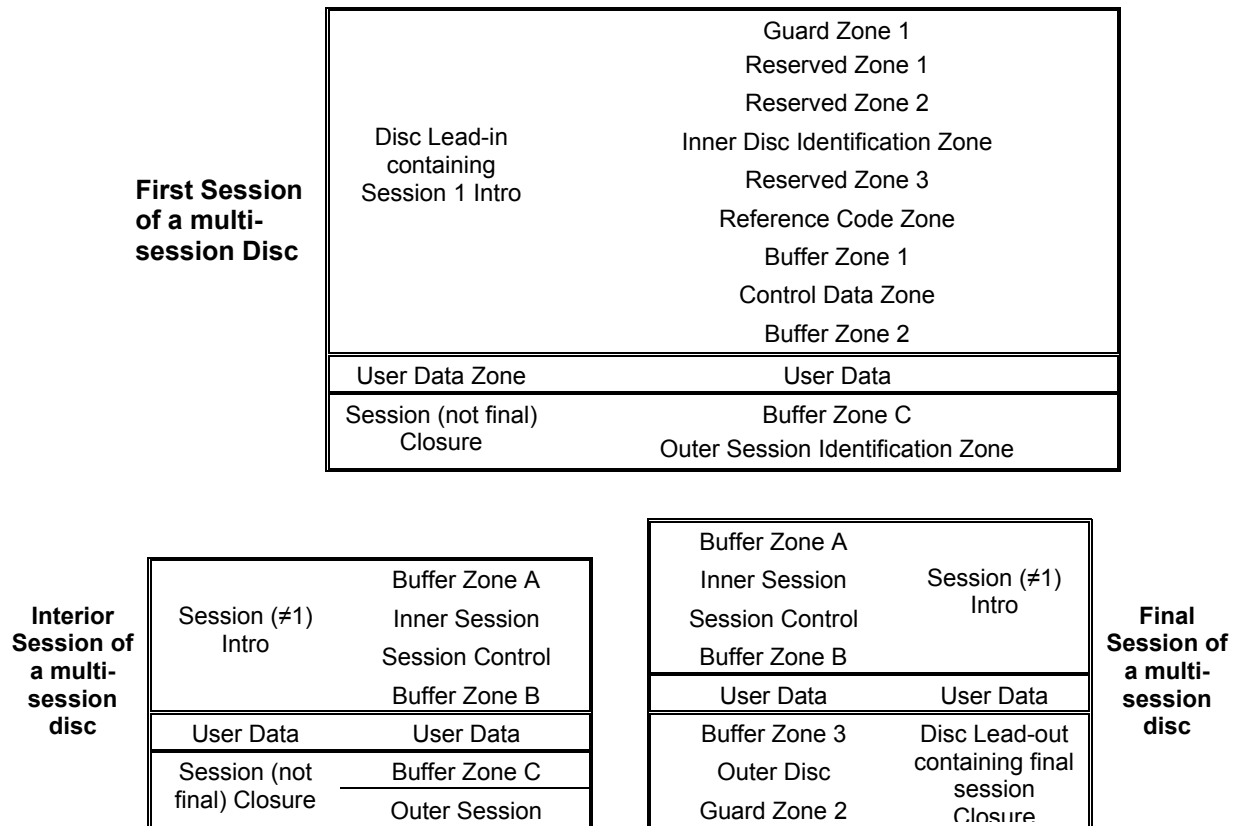

Figure 46 — Zones of a Session

The time to write each of these areas is as follows:

- When session 1 is opened, Reserved Zone 2 plus an SDCB in the first ECC block of the Inner Disc Identification Zone shall be recorded. When session N ($N > 1$) is opened, Buffer Zone A plus an SDCB in the first ECC block of the Inner Session Identification Zone shall be recorded.
- The User Data area is written as the Host provides data.
- When the first ECC block of session 1 is recorded, Buffer Zone 2 shall also be recorded. When the first ECC block of session N ($N > 1$) is recorded, Buffer Zone B shall also be recorded.
- Whenever fragment N (where N is not the first fragment of the session) is opened, a run-in shall be written prior to writing the first ECC block of fragment N.
- The Inner Disc/Session Identification Zone is written incrementally as fragments within the session are defined. When a fragment is defined, a record (the Fragment Item) is included in the Inner Disc/Session Identification Zone that identifies the boundaries of the fragment. When the session is closed, all unused ECC blocks within the Inner Disc/Session Identification Zone are written with all zeros.
- The remaining areas are written when the session is closed. The Outer Disc/Session Identification Zone may optionally contain a copy of the Inner Disc/Session Identification Zone. When the final session is closed, the ECC blocks of the lead-out shall be encoded as lead-out.

Session Oriented Rules:

There may be at most one open session on a disc – the session that contains the current incomplete fragment.

When a session is closed a new ECC block is appended to the Table of Contents Zone (see Table 49) containing a TOC item that identifies the bounds of the new session.

A session may be closed only when every fragment within the session is closed.

4.3.6.2.2 The Host's Perspective

The Host views a DVD+R fragment as a fixed packet track where the packet size is 16. When a DVD+R session is open, fragments and tracks have equivalent meaning. Numbering for CD-R tracks and DVD+R tracks is different. The READ TOC/PMA/ATIP and READ TRACK INFORMATION commands report information about Logical Tracks. Fragments are not always viewed as Logical Tracks. When the user data zone of a closed session is viewed as a Logical Track, its Logical Track number is the session number. Fragments in the open session are viewed as Logical Tracks with:

$$\begin{aligned} \text{Logical Track Number} &= \text{Session Number} \\ &+ \text{Fragment Number} \\ &- \text{Fragment Number of first fragment in session.} \end{aligned}$$

The Host should typically use the following commands for the purpose of inspecting and recording DVD+R media:

READ DISC INFORMATION – Provides detailed information about disc status.

READ TRACK INFORMATION – Provides detailed information about any track. Track number translation is according to the above formula. A reference to track number FFh results in information for the incomplete fragment.

READ TOC/PMA/ATIP (form 0) – Provides general information about tracks on the media. Tracks reported in response to this command represent only closed sessions. Since CD identifies the lead-out as track AAh, the maximum track number is A9h (169d). This provides for a maximum of 153 closed sessions and 16 fragments in the open session. Track number translation is according to the above formula.

READ TOC/PMA/ATIP (form 1) – Provides general information about the last closed session.

WRITE (10 or 12) – Allows writing any sector with location restrictions. The first sector in the write shall begin with the NWA for some track (fragment) in the open session.

SYNCHRONIZE CACHE – When writes to a track (fragment) may not have reached an ECC block boundary, the Host may issue this command in order to ensure that all buffered data is actually written to the disc.

RESERVE TRACK – Provides the Host with the ability to reserve blank disc space for a single track (fragment). The track is not referenced by a number. The fragment shall be created from the beginning of the incomplete fragment. The new, reserved fragment receives the fragment number of the old incomplete fragment, and a new incomplete fragment shall be given the next fragment number. Up to 15 fragments may be reserved in the open session.

CLOSE TRACK/SESSION (Track) – The Host may choose to close a reserved track (fragment) or to define a track (fragment) from the written part of the incomplete fragment.

CLOSE TRACK/SESSION (Session) – For the purpose of making the disc read compatible with a DVD-ROM device, the equivalent of a lead-out (closure) or a real lead-out shall follow user data. The Host may request either case with this command.

4.3.6.2.3 Building from a Blank Disc

When a DVD+R disc is blank, the user definable space begins as session 1, fragment 1 at LBA 0. In this state fragment 1 is incomplete. When beginning recording on a blank disc, the Host has two options: WRITE beginning at LBA 0 or RESERVE TRACK beginning at LBA 0.

- a) If the Host chooses to WRITE, then the Host's data is written beginning with LBA 0. The end address of fragment 1 is still unknown, so fragment 1 remains the only fragment on the disc. When this write is processed by the Drive, it shall record a session identification item in the first ECC block of the Inner Disc/Session Identification Zone, leaving 15 blank ECC blocks in that zone. This allows for at most 15 incrementally defined fragments in the session. In this case the session may contain at most 15 fragments. Writing may proceed until the Host determines that the fragment is completed. At that point the Host may define the fragment as complete by issuing a CLOSE TRACK command. The Drive shall respond by appending an ECC block into the Inner Disc/Session Identification Zone with a new fragment identification item.
- b) If the Host chooses to issue the RESERVE TRACK command, then a size shall be selected. The size is rounded up to an ECC block boundary. At this point, the end address of fragment 1 is known, thereby defining fragment 2 as an incomplete fragment beginning at an ECC block after fragment 1. In executing the RESERVE TRACK command the Drive shall record a session identification item and a fragment identification item (for fragment 1) in the Inner Disc/Session Identification Zone, leaving 15 blank ECC blocks in that zone. This allows for at most 16 incrementally defined fragments in the session. In this case the session may contain at most 16 fragments. The reserved fragment may be written sequentially as the Host deems it necessary.

Subsequent fragment usage operates similarly.

When the user wishes to eject the disc, the Host should elect to close the currently open session prior to disc eject. This ensures that the disc is read compatible with DVD read-only devices. If the user wishes to disallow further writing after the session is closed, it is possible to select a close function to finalize the disc.

4.3.7 DVD+R Double Layer

4.3.7.1 Introduction

The DVD+R Double Layer (DVD+R DL) medium is DVD+R medium with two recording layers physically constructed in order to permit recorded media that is compatible with DVD readers and players. DVD+R DL is constructed to be recorded only as an OTP disc.

This section is an overview of physical and logical formats. Specific format requirements are detailed in [DVD+Ref3].

4.3.7.2 Logical Overview

The basic DVD ECC block structure as defined in 4.3.1.3 applies to DVD+R DL. The sector ID field is viewed as a 32-bit field as shown in Figure 24. For DVD+R DL, the definition of the sector information part of the ID field (Figure 47) differs from other DVD media types.

Sector Information ID Bits 31 thru 24						
31	30	29	28	27	25	24
Sector Format Type	Tracking Method	Reflectivity	Reserved	Zone Type	Data Type	Layer Number

Sector Format Type	0b	Indicates CLV format
Tracking Method	0b	Indicates pit tracking
Reflectivity	1b	Indicates reflectivity is less than 40%
Reserved	0b	Reserved
Zone Type	00b	When sector is in Data Zone
	01b	When sector is in Lead-in Zone
	10b	When sector is in Lead-out Zone
	11b	When sector is in Middle Zone
Data Type	0b	Indicates read-only data
Layer Number	0b	When the sector is on layer 0
	1b	When the sector is on layer 1

Figure 47 — DVD+R DL ID Field Details

4.3.7.3 The Groove

4.3.7.3.1 Logical Disc Layout

As shown in Figure 48, each layer of a DVD+R DL disc has a layout that is similar to single layer DVD+R.

Layer 0		Layer 1	
Disc Area	Zone	Zone	Disc Area
Inner Drive	Initial Zone	Final Zone	Inner Drive
	Inner Disc Test Zone	Inner Disc Test Zone	
	Count Zone Run-in	Dummy Zone	
	Inner Disc Count Zone	Inner Disc Count Zone	
	TOC Zone	Inner Disc Administration Zone	
Lead-in	Guard Zone 1	Lead-out Zone	Lead-out
	Reserved Zone 1		
	Reserved Zone 2		
	Inner Disc ID Zone		
	Reserved Zone 3		
	Reference Code Zone		
	Buffer Zone 1		
	Control Data Zone		
	Buffer Zone 2		
Data	Data Zone	Data Zone	Data
Middle Area	Buffer Zone 3	Buffer Zone 3	Middle Area
	Reserved Zone 3	Reserved Zone 3	
	Guard Zone 2	Guard Zone 2	
Outer Drive	Outer Disc Administration Zone	Outer Disc Administration Zone	Outer Drive
	Outer Disc Count Zone	Outer Disc Count Zone	
	Outer Disc Test Zone	Outer Disc Test Zone	
	Guard Zone 3	Guard Zone 3	

Figure 48 — Logical Layout of a DVD+R DL Disc

A middle zone provides seek over-shoot protection on each layer while providing a mechanism for connecting the two data zones into a logically contiguous user address space.

Note 3. The TOC Zone on DVD+R DL has 127 possible entries for recording session instances. It is possible to record a new L0 middle zone start address without recording a new session instance. **It is possible that this** reduces the possible number of sessions to 126.

4.3.7.3.2 ADIP

As with DVD+R, the blank groove of DVD+R DL has a fixed frequency wobble with information modulated into the wobble. Throughout most of the groove, the wobble information contains only address identification called Address In Pre-groove (ADIP). During the Lead-in Zone, additional information is interleaved between address information blocks. This additional information contains structural information and initial recording parameters. Location information describes the limits of the data zone:

- a. First Sector of Layer 0 Data Zone – ADIP PSN of first sector of the L0 Data Zone
- b. Last Sector of Layer 0 Data Zone – ADIP PSN of last sector of the L0 Data Zone
- c. Last Sector of Layer 1 Data Zone – ADIP PSN of last sector of the L1 Data Zone

The last possible start PSN of the L0 middle zone is the Last Sector of Layer 0 Data Zone plus 1.

4.3.7.4 Recorded Structure

DVD read-only devices are typically unable to maintain tracking over blank areas. In order to maximize playback compatibility with DVD read-only devices, there is one recording restriction:

If a DVD read-only device is tracking on a recorded area on one layer and a layer jump to the other layer is required, the jump must not land in a blank area.

Consequently, when a disc is finalized, a radially equivalent band of recording on layer 1 must match the band of recording in Layer 0. The size of the bands must be large enough to cover any layer offset.

DVD+R DL is recorded in DVD+R session format. An example of the simplest written structure (single session, single fragment) appears as in Figure 49.

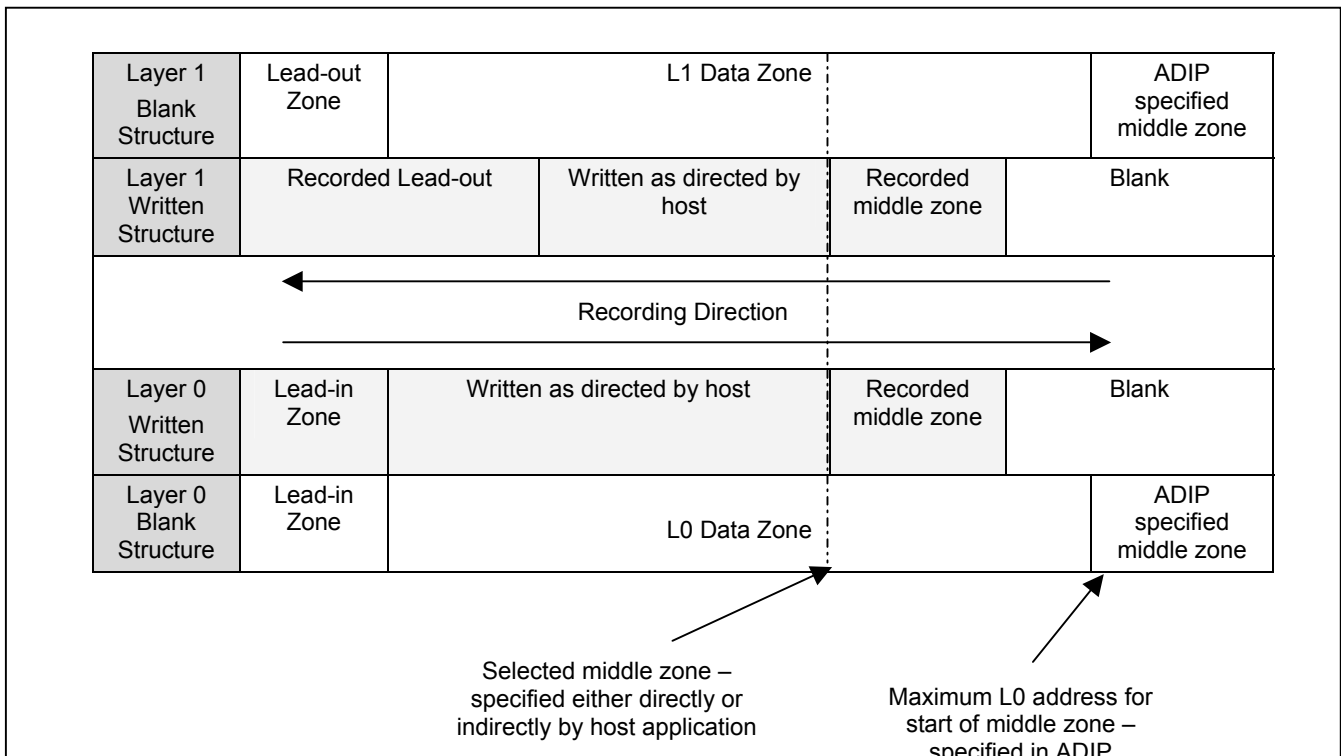

Figure 49 — Blank and Recorded Structure of a DVD+R DL Disc

The middle zone is recorded according to the [DVD+Ref3]. The middle zone is not recorded later than the ADIP specified last possible middle zone start address and has a nominal length of 1 088 ECC blocks. It is permitted to extend a middle zone recording when additional length is needed.

4.3.7.5 Recording on DVD+R DL

Data is recorded sequentially from the beginning of the L0 data zone until the start of the L0 Middle Zone. Recording continues from the end of the L1 Middle Zone until the end of the L1 data zone. A DVD+R DL disc may contain multiple sessions, each consisting of one or more fragments.

The ADIP provides information in the lead-in area that identifies the last possible location for the start of the middle zone on layer 0. The Host is permitted to select a smaller address for this location (See 6.33). The address must:

- be smaller or equal to the ADIP specification,
- be within the incomplete fragment of the first session, and
- begin with a blank ECC block.

This address is written into the Control Data Zone (in the lead-in) when the first session is closed. Consequently, if the Host wishes to select an address other than that supplied in the ADIP, that selection must be made prior to closing the first session.

Figure 50 shows an example of a multi-session disc. A session is permitted to cross layer boundaries.

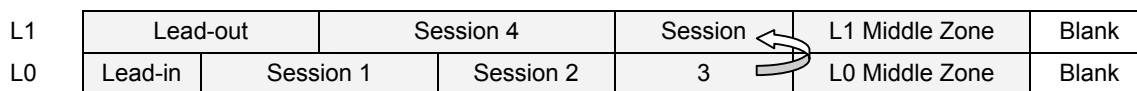

Figure 50 — Example of a DVD+R DL Disc

It is preferred that the L1 middle zone end at the radial position of the start of the L0 middle zone and each middle zones must have at least nominal length.

4.3.7.5.1 Session Structure

4.3.7.5.1.1 Sessions

The session structure is identical to that defined for DVD+R (See 4.3.6.2). The maximum number of sessions on DVD+R DL is 127.

4.3.7.5.1.2 Fragments (Logical Tracks)

The definition of Fragment on DVD+R is identical to the definition of Fragment on DVD+R DL. The numbering of logical tracks on DVD+R DL uses the fragment merging defined in 4.3.6.2.

4.3.7.5.2 Single Layer Recording

A DVD+R DL disc may be recorded as a single layer disc. However, maximum compatibility is obtained when both layers are recorded. If the disc is closed prior to any recording on layer 1, the middle zones should be recorded as middle zone and the remainder of layer 1 should be recorded as lead-out. See Figure 51.

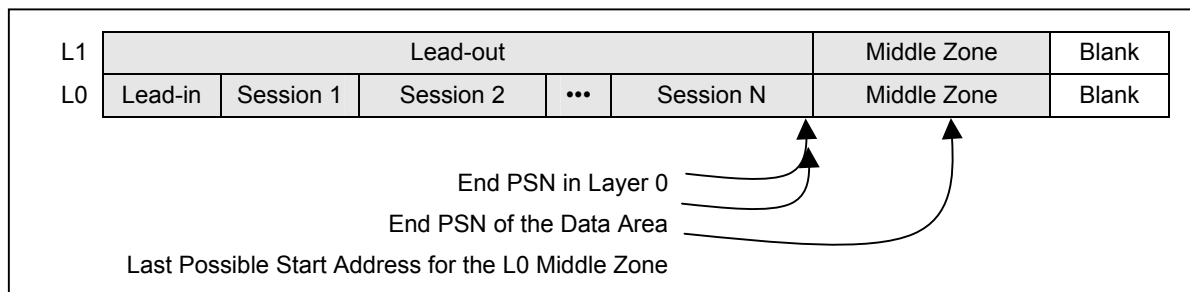

Figure 51 — Preferred Single Layer Recording

4.3.7.5.3 Double Layer Recording: Crossing the Layers

When a layer switch is required at the selected end of L0, recording begins on L1 with 4 run-in blocks in the L1 middle zone preceding user data. See

Figure 52.



Figure 52 — Run-in ECC Blocks in L1 Middle Zone

Since DVD+R DL format follows the DVD+R format, there is only one pre-condition when crossing the layers: Crossing the layers must occur at an ECC block boundary.

A typical example of crossing the layers during recording is shown in Figure 53. In this case, fragment 4 is the incomplete fragment and is written sequentially. When a write command requires more capacity than remains on layer 0, the write continues on layer 1 after 4 run-in blocks have been written into the L1 middle zone. The Middle Zones shall be recorded completely when the Session that contains the layer crossing position is closed or when the disc is finalized, whichever of the two happens first.

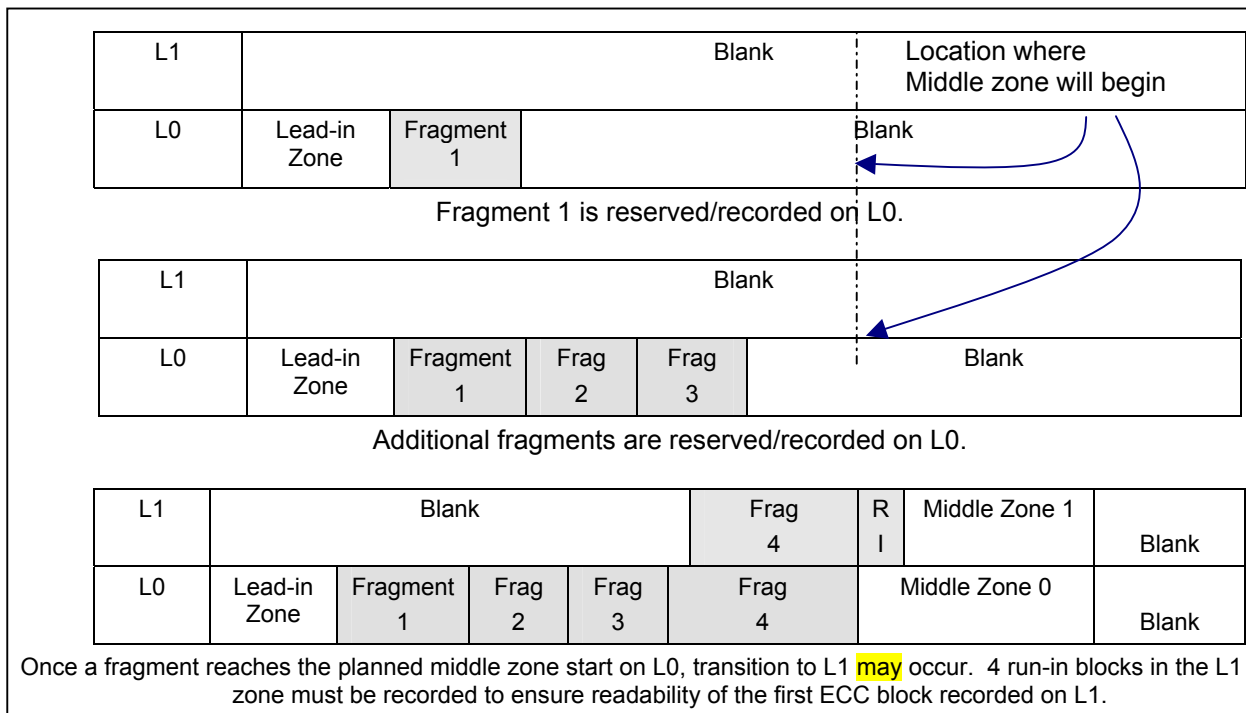

Figure 53 — Example: Crossing the Layers During Recording

Other cases of layer transition are always governed by the DVD+R format. Examples are shown in Table 50.

Table 50 — Examples of Layer Transitions

Situation	Content of the First ECC Block written in the L1 User Data Area
The Intro of a session ends exactly at the end of the L0 user data area.	The first ECC block of the first fragment of the session
A fragment that is not the last fragment ends exactly at the end of the L0 user data area.	The fragment dividing run-in ECC block that appears prior to the next fragment
A run-in ECC block that divides two fragments is exactly the last ECC block of the L0 user data area.	The first ECC block of the next fragment of the session
The last fragment of a session ends exactly at the end of the L0 user data area.	The first ECC block of the session closure. The closure is written when the session is closed. Consequently, both middle zones are also written at this time.
The closure of a session ends exactly at the end of the L0 user data area.	The first ECC block of the Intro of the next session. The middle zones are written when the next session is closed.

In all cases, a middle zone is recorded with a minimum length that is nominal (1 088 ECC blocks).

4.3.7.5.4 Finalization

Predecessors of DVD+R DL do not write any of the lead-out area until the disc is finalized. In order to promote better read-only device compatibility, parts of the lead-out may be written early on a DVD+R DL disc. For this purpose, additional areas are defined on a DVD+R DL disc as shown in Figure 54.

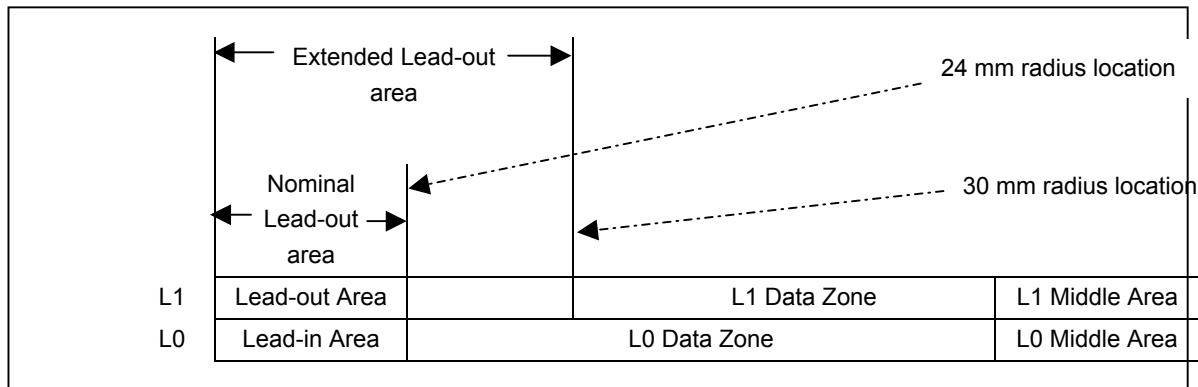

Figure 54 — Finalization Areas on DVD+R DL

The nominal lead-out area is exactly the lead-out area defined in the lead-in ADIP.

The extended lead-out area extends on L1 from an address that approximates a 30 mm radius (approximately the L1 PSN F90000h).

4.3.7.5.5 Finalization Time Deferral

When a DVD+R DL disc is finalized, every ECC block between the lead-in and the L0 middle zone must be recorded, and every ECC block between the L1 middle zone and the lead-out area must be recorded. Due to the large capacity of a DVD+R DL disc, finalization **may** require an extra-ordinary finalization time when only a small part of the user data area has been recorded with data from the Host. If the disc has N sessions, **it is possible to share** the finalization overhead with the closing of session 1.

Finalization **may** be started with closing the first session. Minimally, the nominal lead-out should be recorded during the closure of session 1. It is also permitted to record an extended lead-out. The extended lead-out represents about 13% of the recording size of layer 1. Consequently, recording that part of L1 is not required when the disc is finalized.

4.3.7.6 Read-Only Compatibility

A DVD+R DL disc has greatest read-only device compatibility when every ECC block from the beginning of the lead-in area to the end of the L0 middle zone and from the beginning of the L1 middle zone until the end of the lead-out area is recorded.

A very high level of read-only device compatibility is obtained when only the area between the end of the L1 middle zone and the beginning of the lead-out area remain unrecorded. This level of compatibility is significantly improved when the inner radius of each middle zone is at least 30 mm.

4.3.8 DVD+RW

4.3.8.1 Track Structure

DVD+RW is specified as single layer, either one-sided or two-sided, and available in either 8 centimeter or 12 centimeter.

4.3.8.1.1 The ADIP (Address in Pre-groove)

Like CD-RW media:

- a) DVD+RW media has a wobble structure that defines the groove
- b) Information is modulated onto the wobble
- c) Within the Information Zone, this information contains the address of the associated sector
- d) Within the lead-in, there is additional information about the disc

This is generally called Address-In-Pre-groove or ADIP.

4.3.8.1.2 Logical Structure

The Information zone is organized as a sequence of independently recorded units called ECC blocks.

Each ECC block contains 16 user sectors. Each sector is identified by its PSN and contains 2 048 bytes of data.

Physical addresses advance incrementally beginning at the virtual address 00000000h. It is virtual, because the physical nature of a DVD+RW device guarantees that no Drive is ever be able to reach the sector with PSN = 0. Similarly, the media is made with a zone of protection in the groove. Consequently, the first sector that is required to exist has a PSN significantly larger than 0. As with DVD-ROM, the first user accessible sector has PSN = 30000h. The DVD+RW 120-mm one-sided disc has 4,70 GB available to the user, while the two-sided disc has 9,40 GB. The DVD+RW 80-mm one-sided disc has 1,46 GB available to the user, while the two-sided disc has 2,92 GB.

4.3.8.2 The ECC Block

The basic DVD ECC block structure as defined in 4.3.1.2 applies to DVD+RW. The sector ID field is viewed as a 32-bit field as shown in Figure 24. For DVD+RW, the definition of the sector information part of the ID field (Figure 55) differs from other DVD media types.

Sector Information ID Bits 31 thru 24						
31	30	29	28	27	25	24
Sector Format Type	Tracking Method	Reflectivity	Reserved	Zone Type	Data Type	Layer Number

Sector Format Type	0b	Indicates CLV format
Tracking Method	1b	Indicates groove tracking
Reflectivity	1b	Indicates reflectivity is less than or equal to 40%
Reserved	0b	
Zone Type	00b	When sector is in Data Zone
	01b	When sector is in Lead-in Zone
	10b	When sector is in Lead-out Zone
Data Type	1b	Indicates rewritable data
Layer Number	0b	DVD+RW uses only layer 0

Figure 55 — DVD+RW ID Field

The groove, when recorded, is a continuous sequence of ECC blocks. If ECC block E and E+1 are consecutive, then whenever N is the largest PSN in E, then N+1 is the smallest PSN in E+1. i.e., the ECC blocks are sequenced in an intuitively correct way. The rest of logical groove architecture is given by specific use of individual sectors.

The DVD+RW format provides only a continuous address space with no possibility of defect management. If defect management is desired, it is recommended that the Host use the MRW format (see 4.6). Table 51 shows the zoned layout of the DVD+RW groove.

Table 51 — DVD+RW Media Lay-out

Disc Area	Zone
LEAD-IN	Initial Zone
	Inner Disc Test Zone
	Inner Drive Test Zone
	Guard Zone 1
	Reserved Zone 1
	Reserved Zone 2
	Inner Disc Identification Zone
	Reserved Zone 3
	Reference Code Zone
	Buffer Zone 1
	Control Data Zone
	Buffer Zone 2
DATA	Data Zone
LEAD-OUT	Buffer Zone 3
	Outer Disc Identification Zone
	Guard Zone 2
	Reserved Zone 4
	Outer Drive Test Zone
	Outer Disc Test Zone
	Guard Zone 3

4.3.8.3 DVD+RW Basic Format

Relative to the Host, the Data Zone is the user space and should be addressed according to LBA. The physical to logical address mapping for DVD+RW is the same as that for DVD-ROM: When physical sector number (PSN) represents a sector in the data zone, its LBA = PSN – 030000h.

4.3.8.3.1 Reading

When recorded, DVD+RW medium is ECC block readable. An intelligent controller may separate individual sector data from a decoded ECC block. Thus for the Host, DVD+RW media is 2 048 byte sector readable.

Note 4. The function of locating and separating the data of one specific sector from the appropriate ECC block is typically an automated feature within a silicon sub-system. So, select any 2 sectors within the ECC block. There is virtually no difference in the times required to separate each sector's data from the ECC block. i.e., there is no real performance difference.

4.3.8.3.2 Writing

Since the Host's perception is that the media is sector readable, then in order to maintain compatibility with other block devices, a DVD+RW Drive is able to also write single sectors for its Host.

The Drive is required to write DVD+RW media only in complete ECC blocks. So, the Drive shall often perform a read/modify/write function in order to place the Host's data in the correct position within the ECC block. That works when the ECC block to be written has already been written. When the ECC block has never been written and the Drive shall write less than a full ECC block, then the Drive shall create data. The correct method is to zero fill sectors for which no data is available.

4.3.8.3.3 Formatting

When every ECC block in the Information Zone (lead-in, Data Zone, lead-out) of a DVD+RW has been recorded, the disc is "formatted". [DVD+Ref2], additionally defines specific data content for all sectors. This makes it DVD+RW formatted.

Neither Read nor Write commands shall be accepted prior to format of blank media. When the media is blank and no format is in progress, the Current bit in both the Random Read and Random Writable features shall be zero.

Physically blank DVD+RW media has no data recorded in its groove, so read-only devices find no references on the surface of a blank DVD+RW disc. This has been compared to trying to run on ice. There is no control. So, in order to assure read compatibility with DVD read-only devices, it is very important to have formatted media.

Completely formatting a disc requires more time than is typically desired. To minimize the problem, much of the format time is pushed into background time.

Background formatting has some controlling requirements:

- a) After some minimal amount of formatting has been performed, the operation goes from foreground time to background time. The formatting operation in the Drive should attempt to maintain the Data Zone in two areas: the inner area written and the outer area unwritten. For data applications devices, the formatting bit map in the FDCB shall be implemented in order to minimize excessive reformatting associated with random writing.
- b) The Host should modify its allocation algorithms to minimize blank area fragmentation.
- c) If the user wishes to remove the medium prior to format completion, the Host may request that the Drive create a temporary and minimally acceptable lead-out that allows a continuation of the formatting process at a later time. The Host may also request that the medium be ejected in its current state.
- d) In support of the previous requirement, the Drive shall provide a format re-start mechanism.
- e) The Drive shall always make current format status available to the Host.

Details of how background formatting operates relative to the Host are to be found in the description of the FORMAT UNIT command (6.5).

4.3.9 DVD+RW Dual Layer

4.3.9.1 Track Structure

DVD+RW Dual Layer (DVD+RW DL) medium is designed to be physically consistent with single layer DVD+RW media.

DVD+RW DL is specified as a dual layer one-sided disc. DVD+RW DL is defined to be manufactured in 8 centimeter discs or 12 centimeter discs.

4.3.9.2 Logical Structure

Each layer of each Information zone is organized as a sequence of independently recorded units called ECC blocks. Each ECC block contains 16 user sectors. Each sector is identified by its PSN and contains 2 048 bytes of data.

Physical addresses advance incrementally beginning at the virtual address 00000000h. It is virtual, because the physical nature of a DVD+RW device guarantees that no Drive is ever be able to reach the sector with PSN = 0. Similarly, the media is made with a zone of protection in the groove. Consequently, the first sector that is required to exist has a PSN significantly larger than 0. As with DVD-ROM, the first user accessible sector has PSN = 30000h. The DVD+RW DL 120-mm disc has 8,5 GB available to the user. The DVD+RW DL 80-mm disc has 2,92 GB available to the user.

4.3.9.2.1 The ECC Block

The basic DVD ECC block structure as defined in 4.3.1.3 applies to DVD+RW DL. The sector ID field is viewed as a 32-bit field as shown in Figure 24. For DVD+RW DL, the definition of the sector information part of the ID field (Figure 56) differs from other DVD media types.

Sector Information ID Bits 31 thru 24						
31	30	29	28	27	25	24
Sector Format Type	Tracking Method	Reflectivity	Reserved	Zone Type	Data Type	Layer Number

Sector Format Type	0b	Indicates CLV format
Tracking Method	0b	Indicates pit tracking
Reflectivity	1b	Indicates reflectivity is less than 40%
Reserved	0b	Reserved
Zone Type	00b	When sector is in Data Zone
	01b	When sector is in Lead-in Zone
	10b	When sector is in Lead-out Zone
	11b	When sector is in Middle Zone
Data Type	0b	Indicates read-only data or rewritable data
Layer Number	0b	When the sector is on layer 0
	1b	When the sector is on layer 1

Figure 56 — DVD+RW DL ID Field Details

4.3.9.2.2 Physical Addressing

The concepts for physical addressing on DVD+RW DL are the same as for DVD+R DL. See **Error! Reference source not found.**

4.3.9.3 Groove Layout

4.3.9.3.1 Logical Disc Layout

As shown in Figure 57, each layer of a DVD+RW DL disc has a layout that is similar to single layer DVD+RW.

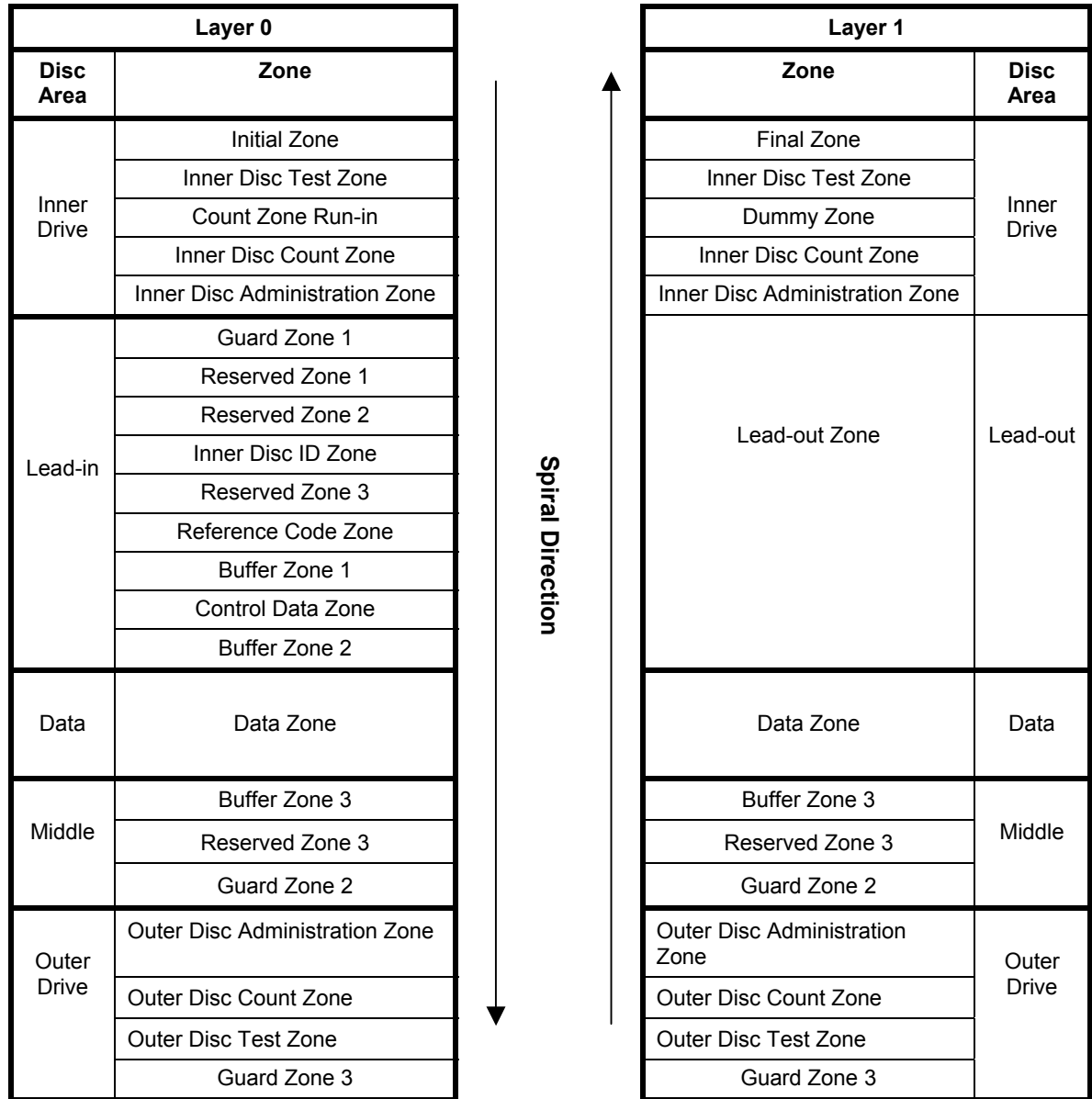

Figure 57 — Logical Layout of a DVD+RW DL Disc

A middle zone provides seek over-shoot protection on each layer while providing a mechanism for connecting the two data zones into a logically contiguous user address space.

4.3.9.3.2 ADIP

As with DVD+RW, the DVD+RW DL blank groove has a fixed frequency wobble with information modulated into the wobble. Throughout most of the groove, the wobble information contains only address identification called Address In Pre-groove (ADIP). During the Lead-in Zone, additional information is interleaved between address information blocks. This additional information contains structural information and initial recording parameters. Location information describes the limits of the data zone:

- a. First Sector of Layer 0 Data Zone – ADIP PSN of first sector of the L0 Data Zone
- b. Last Sector of Layer 0 Data Zone – ADIP PSN of last sector of the L0 Data Zone
- c. Last Sector of Layer 1 Data Zone – ADIP PSN of last sector of the L1 Data Zone

The last possible start PSN of the L0 middle zone is the Last Sector of Layer 0 Data Zone plus 1.

4.3.9.4 Using DVD+RW DL Media

4.3.9.4.1 Reading

When recorded, DVD+RW medium is ECC block readable. An intelligent controller separates individual sector data from a decoded ECC block. Thus for the host, DVD+RW media is 2 048 byte sector readable.

4.3.9.4.2 Writing

Since the host's perception is that the media is sector readable, then in order to maintain compatibility with other block devices, a DVD+RW DL Drive should be able to also write single sectors for its host.

The Drive is required to write DVD+RW media only in complete ECC blocks. So, the Drive should often perform a read/modify/write function in order to place the host's data in the correct position within the ECC block. That works when the ECC block to be written has already been written. When the ECC block has never been written and the Drive should write less than a full ECC block, then the Drive should create data. The correct method is to zero fill sectors for which no data is available.

If ECC block N is written, but the ECC block immediately preceding N is blank, then ECC block N may be unreadable. It is therefore important that the Drive ensure that a written ECC block precedes each ECC block written.

4.3.9.4.3 Formatting

4.3.9.4.3.1 Overview

Formatting on DVD+RW DL operates similarly to background formatting on DVD+RW. The FORMAT UNIT command is used to start the format process, but much of the time dedicated to de-icing the media is performed in background.

DVD+RW has a formatting DCB (FDCB) that contains a bit map identifying the ECC blocks that have been written. DVD+RW DL has two such FDCBs – one for each layer. The use of the FDCBs on DVD+RW DL is similar to that used on DVD+RW.

4.3.9.4.3.2 Normal Start Formatting

The FORMAT UNIT command may be issued requesting Normal Start Formatting. In Normal Start Formatting, the Background formatting process records:

1. Lead-in ECC blocks in the Inner Disc Test Zone through Buffer Zone 2 and
2. Lead-out ECC blocks in Buffer Zone 4 through the Inner Disc Test Zone.

Once the initialization is completed, the FORMAT UNIT command may be terminated with GOOD status while the format process continues in background.

4.3.9.4.3.3 Quick Start Formatting

The FORMAT UNIT command may be issued requesting Quick Start Formatting. In Quick Start Formatting, format writing in the lead-in is minimized prior to beginning de-ice of the Data Zone. It is permitted to perform no recording in either the lead-in or the lead-out. The actual amount of format writing in the lead-in is vendor specific.

The lead-in recording typically includes the recording of all or part of Buffer Zone 2 (Figure 58).

Once the minimal writing is completed, the FORMAT UNIT command may be terminated with GOOD status while the format process continues in background.

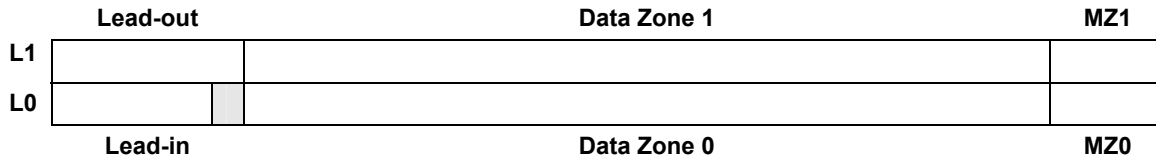

Figure 58 — Foreground part of the format process

4.3.9.4.3.4 Quick Stop

Quick Stop is defined as “quick” relative to normal background formatting. The lead-in area should be completely written and the FDCBs should be written with bit maps that reflect the actual written area of each Data Zone. No temporary middle zone is required. In the Data Zone, there may be unwritten ECC blocks prior to the last user written ECC block.

4.3.9.4.3.5 Compatibility Stop

Compatibility Stop is defined for read compatibility with read-only devices. The lead-in area should be completely written. The data zone with the greatest radial distance of recording should be located. The example in Figure 59 shows that data zone 1 has the greatest radial distance of recording. This point is extended by 64 ECC blocks of zero fill data (area labelled A). Any remaining unrecorded ECC blocks from the end of A to the start of the lead-out shall be format written. The greatest radial distance of recording on data zone 0 shall be extended with format writing to match the radial distance of layer 1 (area labelled B). Any remaining unrecorded ECC blocks from the end of the lead-in to the start of area B shall be format written. The lead-out is written.

If the FDCB bit maps show that any of these areas is already written, then writing again is not required. See Figure 59.

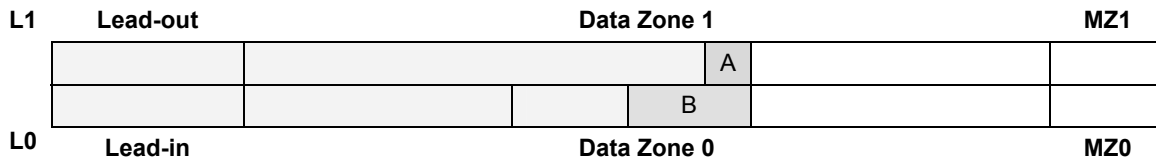

Figure 59 — Compatibility Stop Example

The CDZ is written to indicate that the capacity after formatting has completed.

4.3.9.4.3.6 Restarting

If a background format has been Compatibility Stopped, the format restart simply continues the background formatting as if no stop/restart sequence had happened.

4.3.9.5 Background Formatting Methods for DVD+RW DL

The actual background formatting process is a vendor specific definition. Two possible methods are detailed.

4.3.9.5.1 Single Layer Formatting

Single layer formatting incrementally de-ices layer 1 completely before de-icing layer 0 in a similar, incremental way.

After initialization, formatting continues in background by recording incrementally from the lead-out toward the layer 1 middle zone. See Figure 60 and Figure 61.

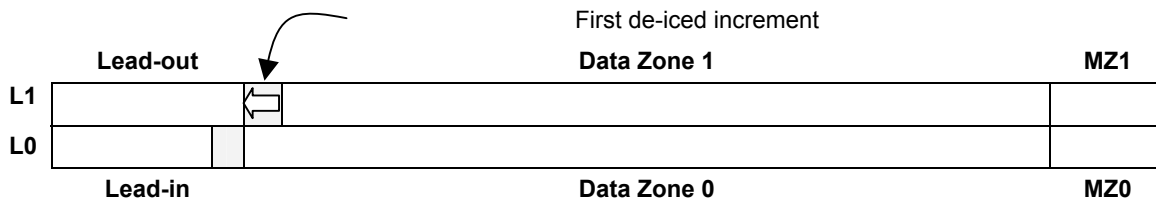

Figure 60 — De-ice first increment

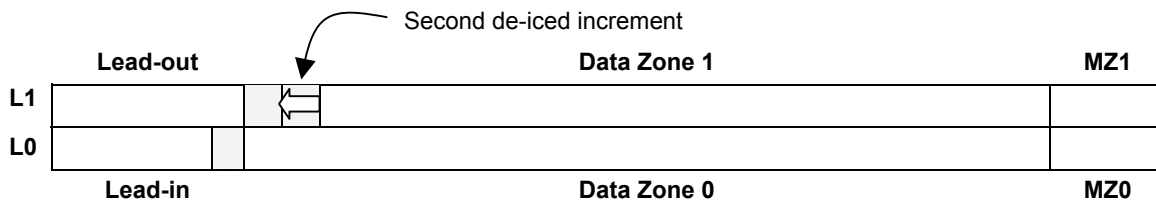

Figure 61 — De-ice second increment

If not stopped, the format of layer 1 will complete and formatting continues on layer 0 in a similar, but forward moving, incremental way. Writes of user data always take precedence over the de-icing process. The status of the format process is maintained in the FDCB, similar to the single layer format process. Unlike the single layer format process, the Last Written Address (LWA) is maintained for each layer.

Regardless of how the format was started (Quick vs Normal), the finished format should have the same appearance as defined in [\[DVD+Ref4\]](#).

When both data zones are fully recorded, the format process enters the finalization part of the format process (Figure 62): both middle zones are written, the lead-out is written, and the lead-in is completely written. If a compatibility stop had been executed, the lead-in and lead-out have already been completely recorded, and only need to be updated.

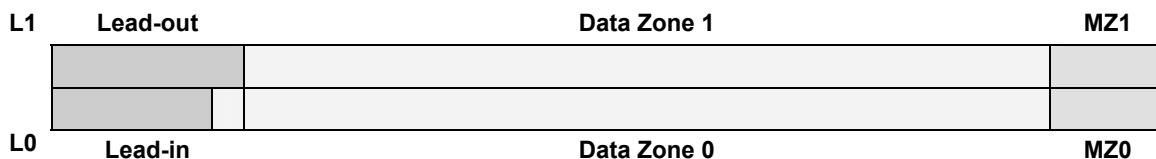

Figure 62 — Finalization part of the format process

4.3.9.5.2 Dual Layer Formatting

Formatting continues in background by recording one increment on layer 0 followed by recording an increment at the same radial position on layer 1 (Figure 60). Each ECC block is encoded as data. The increment size is 512 (tentative) ECC blocks.

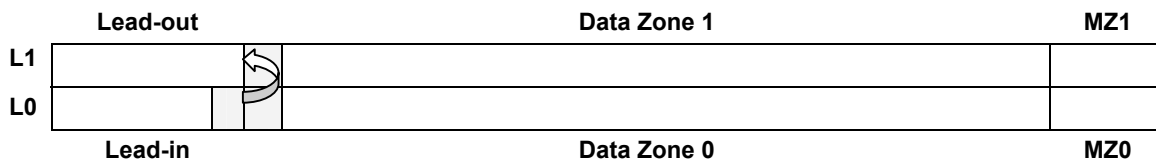

Figure 63 — Start Background part of format process

The incremental formatting continues, filling both layers with zero filled ECC blocks encoded as data (Figure 61).

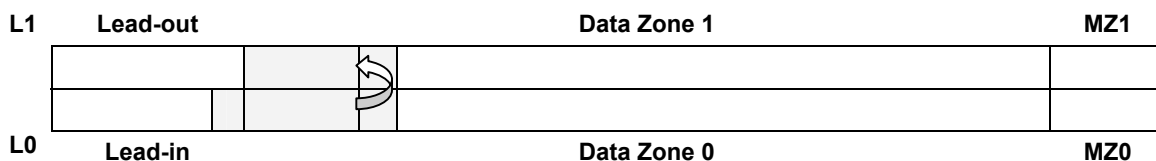

Figure 64 — Background part of format process

If not stopped, the format will complete. Regardless of how the format was started, the finished format should have the same appearance as defined in [DVD+Ref4].

When both data zones are fully recorded, the format process enters the finalization part of the format process (Figure 62): both middle zones are written, the lead-out is written, and the lead-in is completely written. If a compatibility stop had been executed, the lead-in and lead-out have already been completely recorded, and only need to be updated.

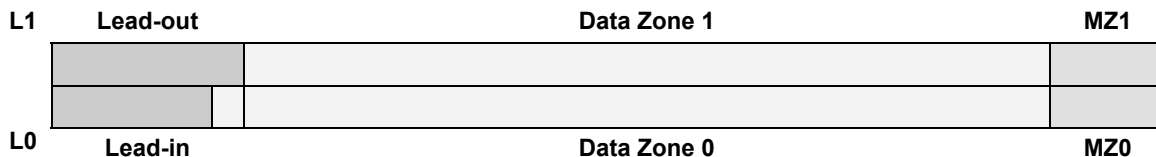

Figure 65 — Finalization part of the format process

4.3.10 Disc Control Blocks

4.3.10.1 Overview

DVD+R, DVD+R DL, DVD+RW and DVD+RW DL media format includes a generalized structure called the Disc Control Block (DCB) that is used for format or use information.

Each Disc Control Block is up to 16 sectors in length. The DCB header is the first 40 bytes of the block. The DCB Header fields have a common definition, while the remaining bytes depend on the value of the Content Descriptor field (see Table 52). The Disc Control Blocks are defined in the [DVD+Ref1], [DVD+Ref2], [DVD+Ref3], and [DVD+Ref4].

If a Disc Control Block, with fewer than 32 768 bytes is read, the Drive shall pad the Disc Control Block with 00h bytes.

Table 52 — Generic Disc Control Block

Bit Byte	7	6	5	4	3	2	1	0
0	(MSB)							
...	Content Descriptor							
3	(LSB)							
4	(MSB)							
...	Unknown Content Descriptor Actions							
7	(LSB)							
8 – 39	Drive ID							
40 - 32 767	DCB Data							

The location of a DCB is dependent upon its content descriptor.

The Address field of the READ DISC STRUCTURE command shall contain a Content Descriptor to identify the Disc Control Blocks (DCB) requested. The Content Descriptor field identifies the contents of bytes 40 – 32 767. Valid values are shown in Table 53.

Table 53 — Valid Values for Content Descriptor

Content Descriptor	Definition
00000000h	Reserved
00000001h – FFFFFFFDh	The DCB with a matching Content Descriptor is returned
FFFFFFFEh	Reserved
FFFFFFFh	Return a list of readable and writable DCB Content Descriptors

The Unknown Content Descriptor Actions field (Table 54) contains a bit mask. This mask describes actions the Drive is allowed to perform if the Drive does not know the Content Descriptor. Each bit, when set to one, prohibits the corresponding action. When set to zero, the corresponding action is allowed.

Table 54 — Unknown Content Descriptor Actions

Bit	Actions
0	Recording within the user data area
1	Reading DCBs
2	Formatting of the medium
3	Modification of this DCB
4–31	Reserved

In the event that the Host violates the instructions of the Unknown Content Descriptor, the associated command shall be terminated with CHECK CONDITION status and SK/ASC/ASCQ values shall be set to ILLEGAL REQUEST/ ILLEGAL FUNCTION.

The Drive ID field contains Drive identification that is vendor specific.

4.3.10.2 Specified DCBs

4.3.10.2.1 The DVD+R and DVD+R DL Session DCB (SDCB)

The format of a Session DCB is shown in .

Bit	7	6	5	4	3	2	1	0
Byte								
40 – 41	Session Number							
42 – 63	Reserved							
64 – 95	Disc ID (included only in lead-in SDCBs)							
96 - 127	Application dependent data							
128 - 143	Session item 0							
144 – 159	Session item 1							
...	...							
8176 - 8191	Last Session Item							
8192 – 16383	Bytes 0 – 8191 repeated							
16384 – 24575	Bytes 0 – 8191 repeated							
24576 – 32767	Bytes 0 – 8191 repeated							

4.4 HD DVD Description

4.4.1 General

The HD DVD Model is the description for the media types defined by the DVD Forum: HD DVD-ROM (Read Only), HD DVD-R (write-once Recordable) and HD DVD-RAM (Rewritable). HD DVD Format is based on the current DVD Format.

- a) HD DVD-ROM is based on DVD-ROM.
- b) HD DVD-R is based on DVD-R.
- c) HD DVD-Rewritable is based on DVD-RAM (not DVD-RW).

The capacities of these different media vary. Some of these media also have the possibility of one or two sides, and independently, one or two layers per side.

4.4.2 Physical Media Characteristics

4.4.2.1 The Disc

HD DVD media is 12 centimeters in diameter and separated into zones as shown in Figure 66.

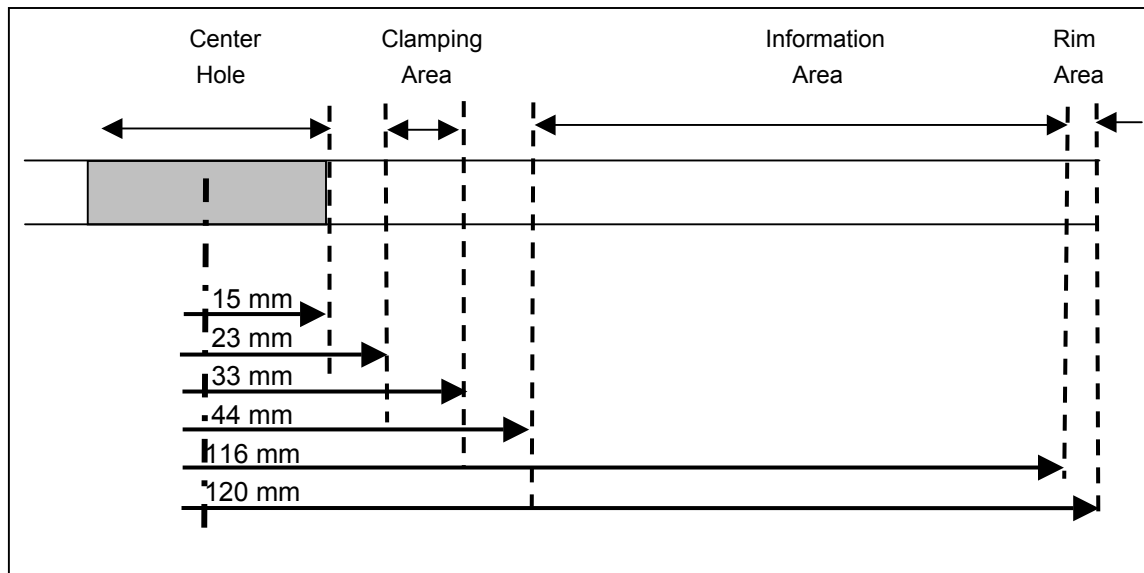

Figure 66 — The Areas of a HD DVD Medium

The Center Hole, Transition Area and Clamping Zone are all part of the alignment and clamping mechanisms. These areas have no direct involvement with the readable/writable areas of the medium.

The Information Zone is the area that actual recording may occur. It contains the lead-in, the data area, and the lead-out. This area typically begins at a radius of 22 millimeters. The information zone ends at a typical radius of 58 millimeters.

The Rim Area is simply the area beyond the data groove. It typically ends at a radius of 60 millimeters.

4.4.2.2 Track Structure

The physical track structure of HD DVD is similar to DVD: a continuous spiral. With respect to HD DVD-RAM, the physical track structure is a double spiral (land and groove). Each spiral begins near the inner radius and ends near the outer radius.

HD DVD provides the ability to use two focus depths like DVD.

There are up to 4 possibilities for physical track structure:

- a) Single sided, single layer
- b) Single sided, dual layer
- c) Two sided, single layer,
- d) Two sided, dual layer.

There are two types of track path for dual layer discs, either parallel or opposite.

4.4.3 Logical Structure

4.4.3.1 ECC Blocks

When fully recorded, each track consists of an uninterrupted sequence of ECC blocks. Each ECC block contains 32 sectors of 2 048 data bytes each. Sectors are numbered with a 24-bit address. Numbering is linear and integral, beginning with zero. Sector zero exists only for the purposes of definition. No device has the need to access any sector with PSN smaller than 022640h.

An ECC block consists of 32 sectors with headers, EDC symbols, and ECC symbols. Individual sector data are interleaved in order to minimize the effects of large media flaws. These ECC blocks are recorded serially on the medium.

In order to read and extract a single sector of data, the Drive shall read the ECC block containing the sector, apply error correction to the ECC block, and de-interleave prior to extracting the data from the selected sector.

4.4.3.1.1 The Structure of the Data Sector

A HD DVD data sector contains 2 064 bytes, containing 2 048 bytes of main data and 16 bytes of additional information.

The logical layout of a HD DVD data sector is shown in Figure 67.

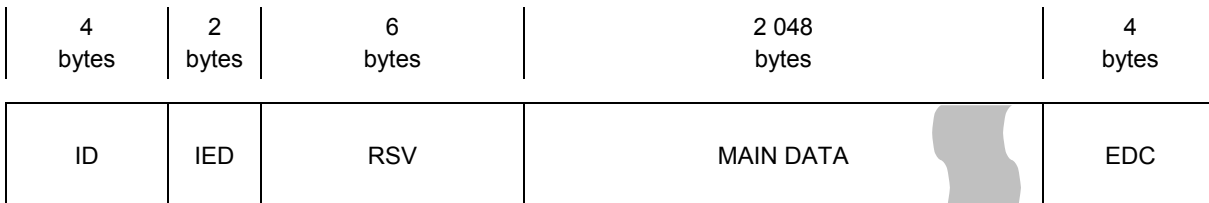

Figure 67 — Logical Layout of a HD DVD Data Sector

ID is a field that identifies the sector

IED contains 2 bytes of redundancy as an error detection code (EDC) for the ID field.

RSV is reserved and shall be recorded with zeros.

MAIN DATA contains 2 048 information bytes.

EDC contains 4 bytes of redundancy as an error detection code (EDC) for the entire sector.

The ID field is viewed as a 32-bit field as shown in Figure 68



Figure 68 — HD DVD ID Field

Sector Information varies for different HD DVD media types.

Physical Sector Number (PSN) The least significant 24 bits (bits 23 through 0) contains the PSN in binary notation. The PSN of the first Physical Sector of an ECC Block shall be an integral multiple of 32.

4.4.3.1.2 The Structure of the ECC Block

The HD DVD ECC block is structured as 2 DVD ECC blocks (see **Figure 25**).

A 2064-byte sector is divided into 6 rows of 344 bytes each. Main data is scrambled. 32 sequential sectors are packed a single structure of 192 rows, each with 172 bytes×2. Error correction redundancy symbols are appended in order to produce 208 rows of 182 bytes×2 each.

The organization of sector data and redundancy symbols within an ECC block is illustrated in Figure 69. Columnar symbols (Cx,y) are calculated and appended to rows, then Row symbols (Rx,y) are calculated and appended to columns. Columnar redundancy symbols are collectively known as Inner Parity (PI). Row redundancy symbols are collectively known as Outer Parity (PO).

		User Data			ECC Row Parity			User Data			ECC Row Parity		
User Data		B0,0	...	B0,171	C0,0	...	C0,9	B0,172	...	B0,343	C0,10	...	C0,19
		B1,0	...	B1,171	C1,0	...	C1,9	B1,172	...	B1,343	C0,10	...	C0,19
									
		B191,0	...	B191,171	C191,0	...	C191,9	B191,172	...	B191,343	C191,10	...	C191,19
ECC Column Parity		R0,0	...	R0,171	C192,0	...	C192,9	R0,172	...	R0,343	C192,10	...	C192,19
	
		R15,0	...	R15,171	C207,0	...	C207,9	R15,172	...	R15,343	C207,10	...	C207,19

Figure 69 — HD DVD ECC Block Structure

Each of the 32 sectors of an ECC block has a unique PSN. The PSNs are sequential such that if the smallest is N, then N+1, N+2, N+3, ..., N+31 are also present in the ECC block. i.e., the sectors are sequenced in an intuitively correct way.

4.4.3.2 The Lead-in Area

The Lead-in Area has the general arrangement shown in Figure 70. The Lead-in area consists of the System Lead-in area, the Connection area and the Data Lead-in area. The structure of the Data Lead-in area varies according to media type.

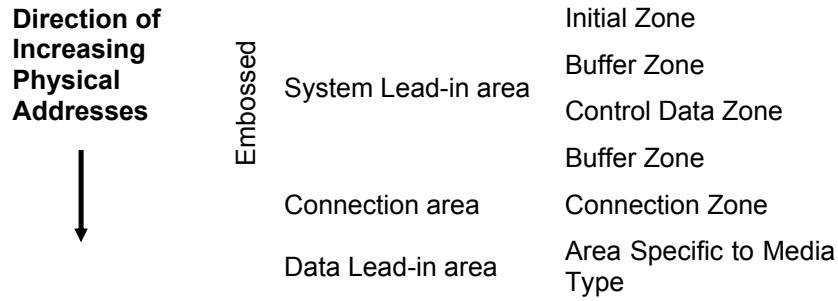

Figure 70 — General Layout of Lead-in area

4.4.4 HD DVD-ROM

4.4.4.1 Track Structure

HD DVD-ROM may have any of the 4 structures like DVD-ROM:

- a) single sided, single layer,
- b) single sided, dual layer,
- c) two sided, single layer,
- d) two sided, dual layer.

In all cases, a track is one layer on one side of the media.

4.4.4.2 Sector Structure

HD DVD-ROM ECC block structure is consistent with the definition in 4.4.3.1. For HD DVD-ROM, the definition of the sector information part of the ID field is shown in Figure 71.

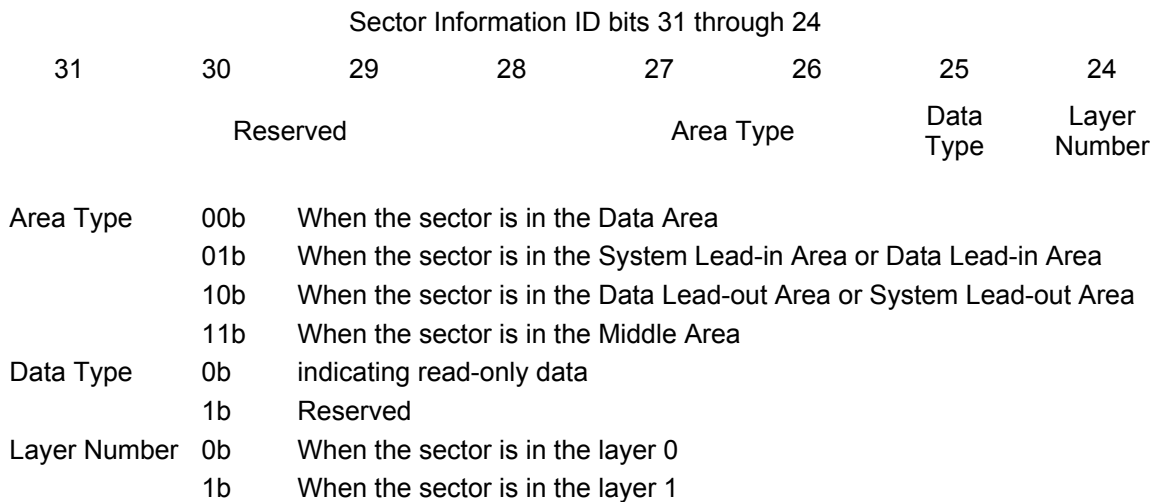

Figure 71 — ID Field for HD DVD-ROM

4.4.4.3 The Lead-in Area

The HD DVD-ROM lead-in structure is consistent with the structure shown in Figure 70. Table 55 shows the lead-in structure specific to HD DVD-ROM.

Table 55 – HD DVD-ROM Lead-in Structure

Area	Zone	Start PSN
	Initial Zone	-
System Lead-in Area	Buffer Zone	1E000h
	Control Data Zone	1E400h
	Buffer Zone	1FC00h
Connection Area	Connection Zone	1FFFFh
	Reserved	26B00h
Data Lead-in Area	Reference Code Zone	2FFE0h
		30000h
Data Area		:

4.4.5 HD DVD-R

4.4.5.1 Track Structure

HD DVD-R may have any of the 2 structures:

- a) single sided, single layer,
- b) two sided, single layer,

In all cases, a track is one layer on one side of the media.

4.4.5.2 Sector Structure

HD DVD-R ECC block structure is consistent with the definition in 4.4.3.1. For HD DVD-R, the definition of the sector information part of the ID field is shown in Figure 72.

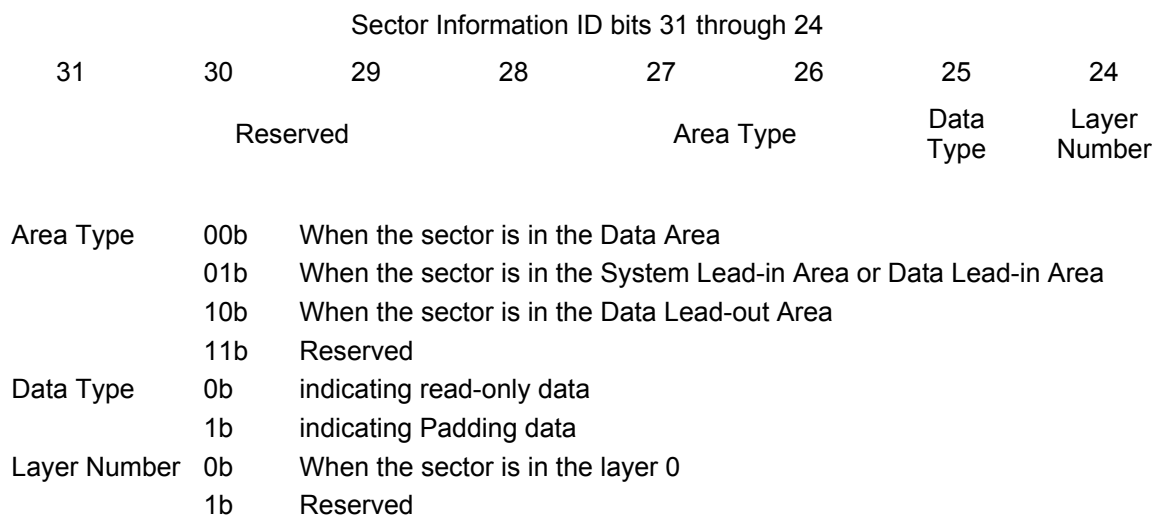

Figure 72 — ID Field for HD DVD-R

4.4.5.3 The Lead-in Area

The HD DVD-R lead-in structure is consistent with the structure shown in Figure 70. Table 56 shows the lead-in structure specific to HD DVD-R.

Table 56 – HD DVD-R Lead-in Structure

Area	Zone	Start PSN
System Lead-in Area	Initial Zone	-
	Buffer Zone	1E000h
	Control Data Zone	1E400h
Connection Area	Buffer Zone	1FC00h
	Connection Zone	1FFFFh
Data Lead-in Area	Guard Track Zone	26B00h
	Disc Test Zone	27000h
	Drive Test Zone	27200h
	Guard Track Zone	2BD00h
	RMD Duplication Zone	2BE00h
	Recording Management Zone	2CE00h
	R-Physical Format Information Zone	2FF00h
	Reference Code Zone	2FFE0h
Data Area		30000h :

4.4.5.4 HD DVD-R Recording

HD DVD-R is similar to DVD-R. It is a write-once media that in most cases will be readable by a HD DVD-ROM Drive. The concepts of RZone, Border Zone, Recording Management Data and Next Writable Address are the same as DVD-R.

Some major differences between HD DVD-R and DVD-R are linking, finalizing scheme, extendable Recording Management Zone and extendable Drive Test Zone. HD DVD-R has no linking loss. There is no definition for a BSGA.

4.4.6 HD DVD-RAM

4.4.6.1 Track Structure

HD DVD-RAM may have any of the 2 following structures:

- a) single sided, single layer,
- b) two sided, single layer,

The System Lead-in consists of a single, embossed track path. There are two recordable track paths in each of the other disc areas: Data Lead-in, Data Area and Data Lead-out. Each spiral begins near the inner radius and ends near the outer radius. The Physical Sector Numbering sequence is as follows:

1. System Lead-in,
2. PSN discontinuity associated with the Connection Zone,
3. Data Lead-in on land,
4. Data Area on Land,
5. Data Lead-out on Land,
6. PSN discontinuity associated with the Connection Zone,
7. Data Lead-in in groove,
8. Data Area in groove, and
9. Data Lead-out in groove.

The track structure of HD DVD-RAM (single sided, single layer) is shown in Figure 73.

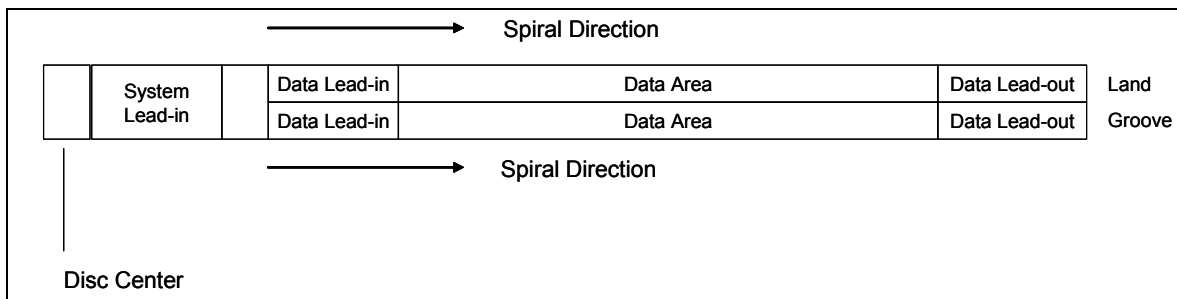

Figure 73 — Single Layer, Single Sided Disc

4.4.6.2 Sector Structure

DVD-RW ECC block structure is consistent with the definition in 4.4.3.1. For HD DVD-RAM, the definition of the sector information part of the ID field is shown in Figure 74.

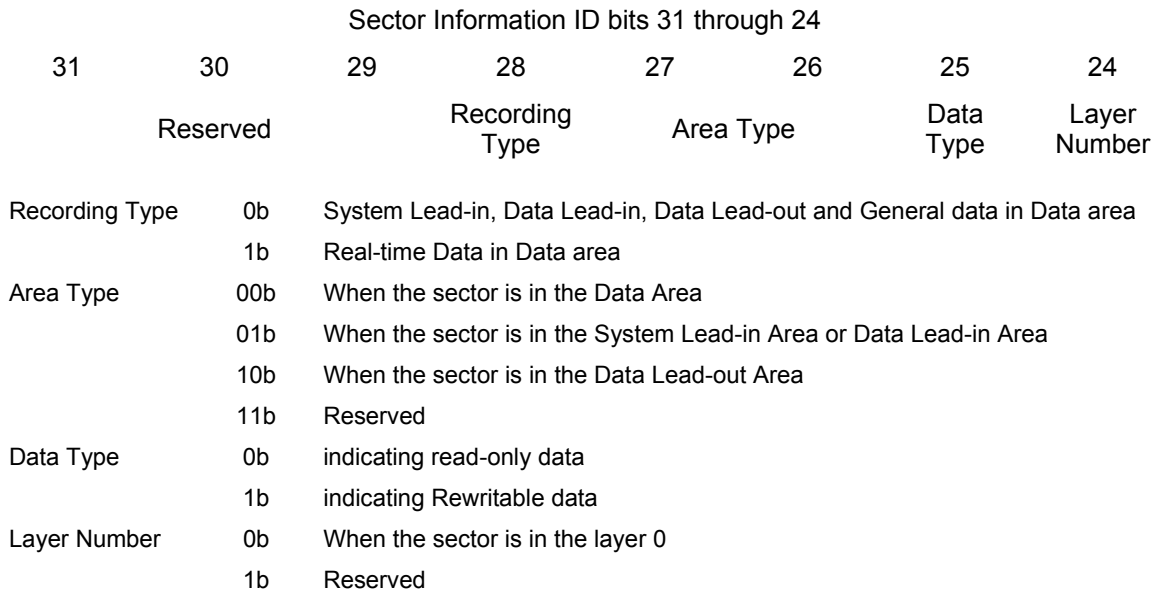

Figure 74 — ID Field for HD DVD-RAM

4.4.6.3 The Lead-in Area

The HD DVD-RAM lead-in structure is consistent with the structure shown in Figure 70. Table 57 shows the lead-in structure specific to HD DVD-RAM.

Table 57 — HD DVD-RAM Lead-in Structure

Area	Zone	Start PSN	
	Initial Zone	-	
System Lead-in Area	Buffer Zone	1E000h	
	Control Data Zone	1E400h	
	Buffer Zone	1FC00h	
Connection Area	Connection Zone	No PSNs assigned	
		land	groove
Data Lead-in Area	Guard Track Zone	29A00h	829A00h
	Disc Test Zone	2A400h	82A400h
	Drive Test Zone	2B400h	82B400h
	Guard Track Zone	2CA00h	82CA00h
	Disc Identification Zone	2CD00h	82CD00h
	Defect Management Zone	2CE00h	82CE00h
Data Area		30000h :	830000h :

4.4.6.4 HD DVD-RAM Recording

HD DVD-RAM is similar to DVD-RAM. HD DVD-RAM is randomly writable in ECC block increments. Random writability in 2 048 byte sectors is accomplished by read-modify-write actions with ECC blocks. HD DVD-RAM implements a defect management that provides for a seamless LBA space for the Initiator. Consequently, HD DVD-RAM implements the Removable Disk Profile.

HD DVD-RAM media has zones much like notching on magnetic disk drives. A zone is a set of contiguous sectors on the disc such that:

1. The number of sectors per revolution, R , is consistent across the zone.
2. There is an integer, Z , such that $Z \times R$ is the number of sectors in the zone.

If Zone N starts at a smaller radius than zone M , then the number of sectors per revolution of zone N is less than the number of sectors per revolution in zone M .

HD DVD-RAM media is divided into 19 zones as shown in Figure 75

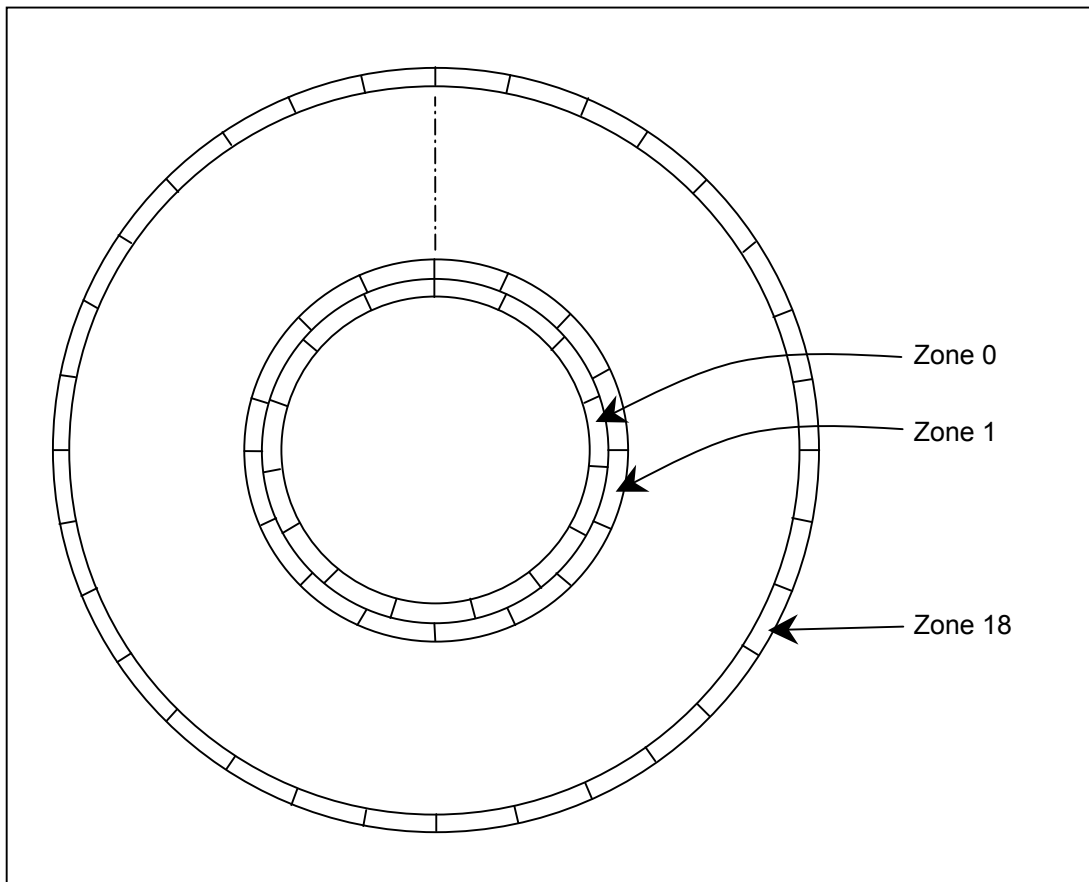

Figure 75 — HD DVD-RAM Zoning

4.5 Blu-ray Disc (BD)

4.5.1 Overview

4.5.1.1 General

Blu-ray Disc (BD) describes the optical and physical characteristics of 120 mm optical discs. The discs support Single Layer (SL) and Dual Layers (DL). The SL disc has a capacity of 25.0 Gbytes. The DL disc has a capacity of 50.0 Gbytes.

The BD system also allows 80 mm discs, both in a Single Layer version and a Dual Layer version with capacities of 7.8 Gbytes and 15.6 Gbytes respectively. These discs have the same characteristics as the 120 mm discs, except for some parameters related to the smaller dimensions.

BD is defined in three disc types:

- a) BD Read-only (BD-ROM),
- b) Recordable (BD-R) – a write-once media, and
- c) Rewritable (BD-RE).

4.5.1.2 The Spiral

The spiral of each BD layer is consistent with the general case described in 4.1.2. Dual layer BD is defined only for OTP discs.

4.5.1.3 Logical Blocks, Sectors and Clusters

The logical block size of BD is 2 048 bytes. A BD sector contains the data of one logical block and 18 bytes of control information. A group of 32 sectors are collected into a recorded unit called a Cluster.

- a) The user data within a BD sector is protected by the error correction coding in the Cluster that contains the sector.
- b) BD discs may consist of one or two layers. In the case of two layers, the user area of each disc appears to the Host as a single continuous address space.

4.5.2 BD-ROM

4.5.2.1 Overview

BD-ROM is a read-only media with the general characteristics described in **Error! Reference source not found.**

4.5.2.2 Track Structure

The single layer BD disc information zone (

Figure 76) is contained within a continuous spiral that begins near the inner radius and proceeds until the outer radius. The information zone is divided into three areas: the Lead-in Zone (Inner Zone 0), Data Zone, and Lead-out Zone (Outer Zone 0).

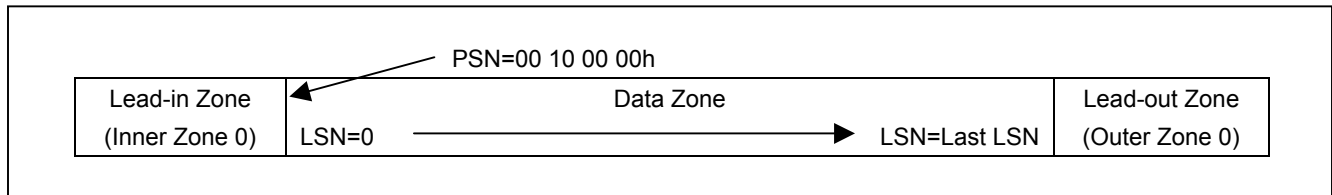

Figure 76 — Layout of Single Layer BD-ROM Information Zone

The layer 0 information zone of a dual layer BD disc (Figure 77) is contained within a continuous spiral that begins near the inner radius and proceeds until the outer radius. The layer 1 information zone of a dual layer BD disc is contained within a continuous spiral that begins near the outer radius and proceeds until the inner radius. The layer 0 information zone is divided into three areas: the Lead-in Zone (Inner Zone 0), Data Zone 0, and Outer Zone 0. The layer 1 information zone is divided into three areas: Outer zone 1, Data Zone 1, and the Lead-out zone (Inner Zone 1).

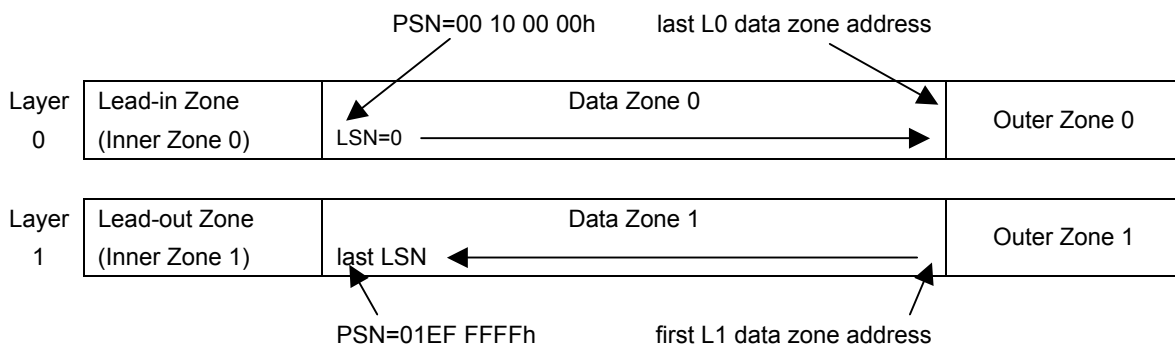

Figure 77 — Layout of Dual Layer BD-ROM Information Zone

4.5.2.3 The Information Zone

The information zone of a dual layer BD-ROM disc (Figure 78) is the accessible spirals.

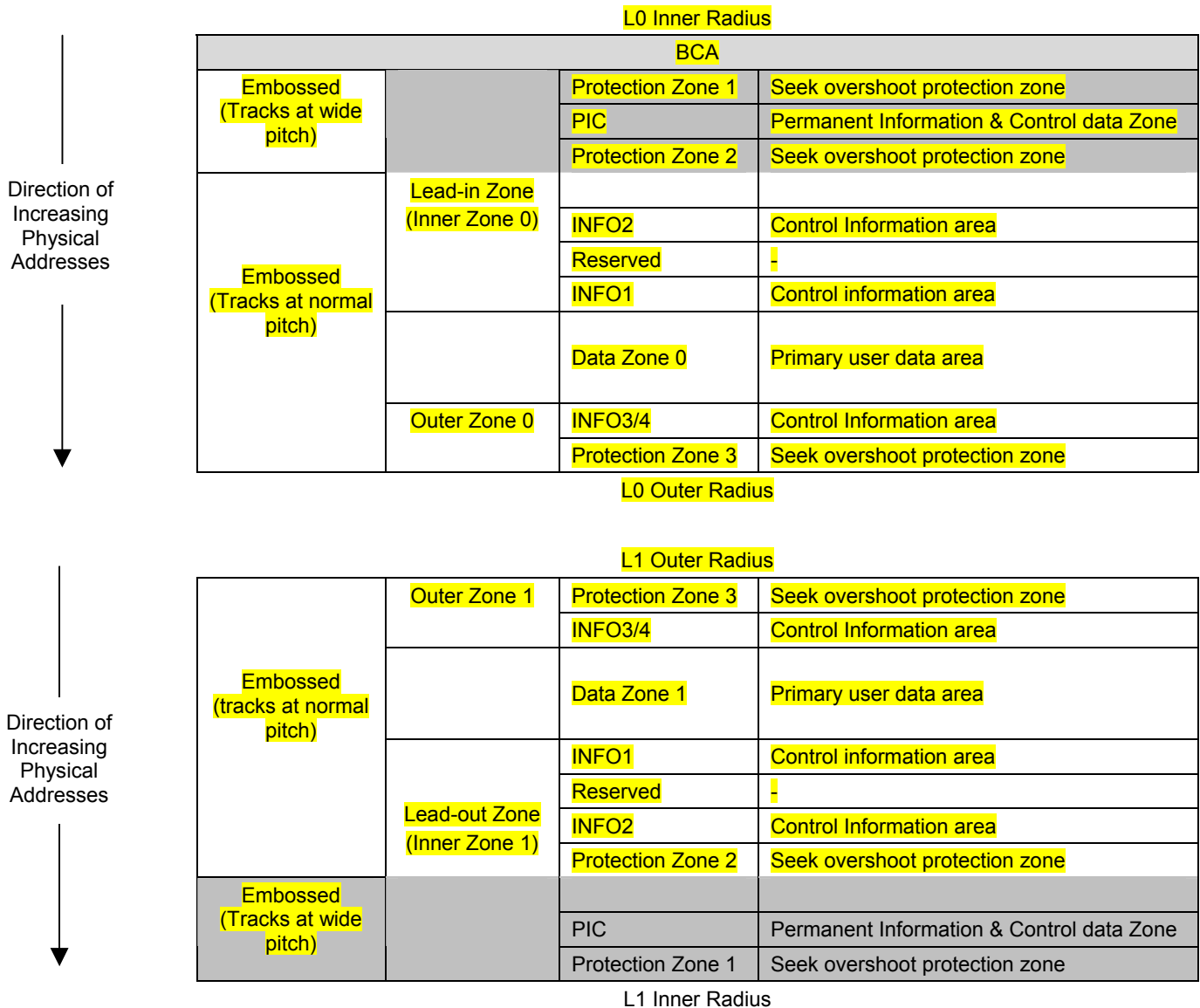

Figure 78 — BD-ROM Information Zone

4.5.2.3.1 Burst Cutting Area (BCA)

The Burst Cutting Area (BCA), if present, contains application specific information.

4.5.2.3.2 Embossed Zone (tracks at wide pitch)

The Embossed area consists of:

Protection Zone 1	This zone exists for seek overshoot protection at the disc's inner radius.
Permanent Information & Control data zone (PIC)	On layer zero, this embossed zone contains disc information that includes, but is not restricted to: <ol style="list-style-type: none"> 1. Physical media class and version 2. Physical address of the start of the Data Zone 3. Physical address of the start of the outer zone (if this is a single layer media, this is the Lead-out) 4. Number of layers 5. Recording Density 6. Write power information <p>On layer 1 this embossed zone contains a copy of the layer 0 information, but the physical addresses refer to physical addresses on layer 1.</p>
Protection Zone 2	This zone is a buffer area between the 2 track pitches. The first part of this zone has wide pitch.

4.5.2.3.3 Inner Zone 0 (Lead-in Zone)/Inner Zone 1 (Lead-out Zone)

An Inner Zone consists of:

Protection Zone 2	This zone is a buffer area between the 2 track pitches. The second part of this zone has normal pitch.
INFO2	This zone is intended to contain information specific to the application.
Reserved	This zone is reserved. Each Cluster shall contain only zeros.
INFO1	This zone is intended to contain control information.

4.5.2.3.4 Data Zone

The data zone contains application data that is readable by the Host as a sequence of sectors.

4.5.2.3.5 Outer Zone 0 (Lead-out Zone)/Outer Zone 1

On single layer media the Outer Zone has the function of the Lead-out Zone. On dual layer media, the Outer Zone 0 and Outer Zone 1 are layer transition zones on layer 0 and layer 1, respectively. The Outer Zone consists of:

INFO3/4	This zone is intended to contain control information.
Protection Zone 3	This zone exists for seek overshoot protection at the disc's outer radius.

4.5.2.4 Access Model

The access model for BD is based upon the random access read-only device model:

- The user data space is organized in fixed size blocks (2 048 bytes/block) and addressed as logical blocks. Blocks in this Logical Block Address space may be read using only the READ (10) and READ (12) commands.
- Logical block addresses are numbered from 0 through READ CAPACITY LBA. The value of READ CAPACITY LBA is the logical block address returned by the READ CAPACITY command.
- The READ TOC/PMA/ATIP command is implemented to assure compatibility with existing applications. Only formats 0 and 1 are implemented. Some structures may be fabricated.
- Structures unique to BD may be read using the READ DISC STRUCTURES command.

4.5.3 BD-R

4.5.3.1 Overview

BD-R is a write-once media with the general characteristics described in **Error! Reference source not found..**

4.5.3.2 Blank Media Structure

BD-R is a write-once media that may consist of one or two layers. Each layer consists of single continuous spiral structured only as opposite-track-path.

4.5.3.2.1 Primary Zones

Each layer is separated into 3 primary zones: Inner, Data, and Outer.

On single layer discs, the Inner Zone is used as the disc Lead-in and the Outer Zone is used as the disc Lead-out. See Figure 79.

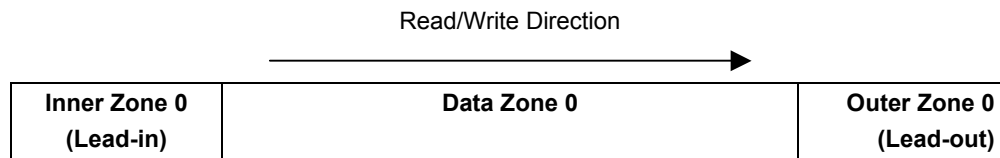

Figure 79 — Primary Zones of a Single Layer BD-R

On dual layer discs, the layer 0 Inner Zone is used as the disc Lead-in and the layer 1 Inner Zone is used as the disc Lead-out. The two Outer Zones are used as layer transition zones. See Figure 80.

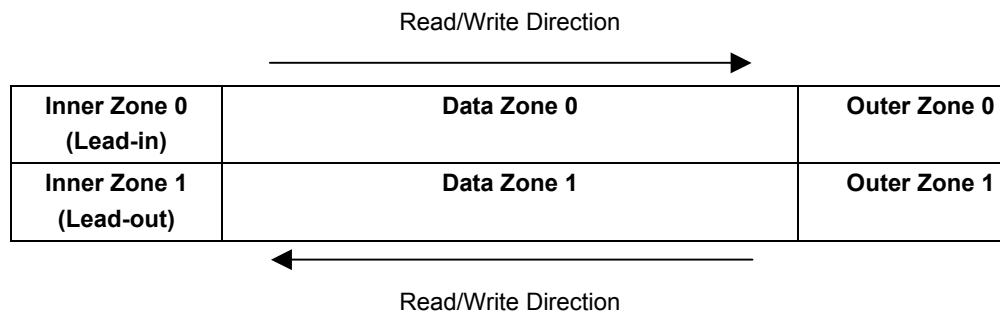

Figure 80 — Primary Zones of a Dual Layer BD-R

4.5.3.2.2 Capacity

BD-R capacity is determined by the size of the Data Zones. Possible BD-R disc capacities are shown in Table 58.

Table 58 — BD-R Disc Capacities

Diameter	Single Layer	Dual Layer
80 mm	7.8 GB	15.6 GB
120 mm	25.0 GB	50.0 GB

4.5.3.2.3 ADIP

BD-R has a single grooved track with a fixed frequency wobble. The wobble contains modulated location information called Address In Pre-groove (ADIP).

In the Inner Zones, the ADIP address information is interleaved with disc information called Disc Information (DI) frames. The collection of DI frames contains information about the logical disc structure as well as recording parameters.

The DI is repeated in pre-recorded areas that occur prior to the Inner Zones.

4.5.3.2.4 Un-recorded Sector Addressing

Any BD drive that supports reading BD-R is able to seek to any sector on a BD-R disc. Neither Lead-in Zone nor Lead-out Zone needs to be completely written.

4.5.3.2.5 Groove Layout

Each layer of the BD-R Information Zone is divided into an embossed (pre-recorded) high frequency modulated (HFM) area and a recordable area. The detailed groove layout is shown in Figure 81.

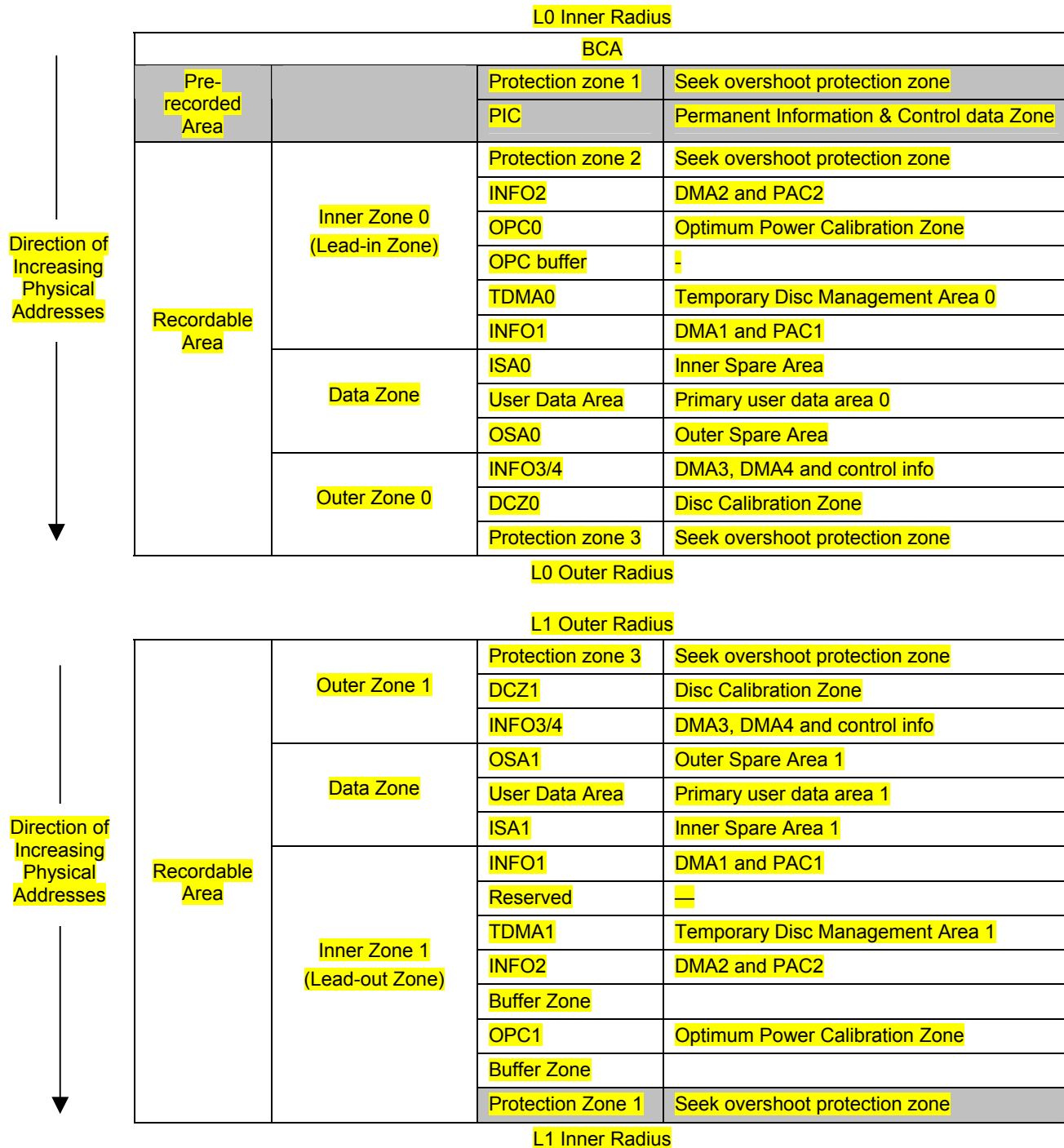

Figure 81 — BD-R Information Zones

The recordable area of each layer is divided into an Inner Zone, a data zone, and an Outer Zone.

On a single layer disc the Inner Zone is used as a disc Lead-in and the Outer Zone is used as a Lead-out.

On a dual layer disc, Inner Zone 0 is the disc lead-in, Inner Zone 1 is the disc lead-out, and the Outer Zones are layer transition areas.

For a detailed description of specific zones, consult [BD-Ref2].

4.5.3.2.6 Burst Cutting Area (BCA)

The BCA is used to add information to the disc after completion of the manufacturing process. The BCA-code is typically written by a high-power laser system in the case of Recordable discs.

4.5.3.2.7 Pre-recorded Zone

The Pre-recorded zone consists of:

Protection Zone 1 Protection Zone 1, on each layer, is meant as a protection area against overwriting the PIC zone by the Burst Cutting Area (BCA) that precedes the normal recording spiral.

Permanent Information & Control data Zone (PIC) On layer zero, this pre-recorded area contains disc information that includes, but is not restricted to:

1. Physical media class and version
2. Physical address of the start of the Data Zone
3. Physical address of the start of the outer zone (if this is a single layer media, this is the lead-out)
4. Number of layers
5. Recording Density
6. Write power information

On layer 1 this pre-recorded area contains a copy of the layer 0 information, but the physical addresses refer to physical addresses on layer 1.

4.5.3.2.8 Lead-in Zone (Inner Zone 0)

An Inner Zone consists of:

Protection Zone 2 On both layers, this zone buffers the rewritable area from the embossed area.

INFO2 On both layers, INFO2 is reserved for DMA and PAC storage.

Optimum Power Calibration (OPC) Zone On both layers, the OPC Zone is reserved for testing and calibration.

TDMA0, 1 Temporary Disc Management Areas

INFO1 On both layers, this area is reserved for DMA and PAC storage.

4.5.3.2.9 Data Zone

The Data Zone consists of:

Inner Spare Areas (ISA0, ISA1) If spare Clusters are allocated for defect management, then ISA0 contains 4 096 Clusters and ISA1 has a maximum size of 16 384 Clusters allocated in 256 Cluster increments. Any part of the data zone that is not allocated for the ISAs is part of the User Data Area. A TDMA may be allocated in increments of 256 Clusters from any Spare Area. This action reduces the size of the Spare Area by the amount allocated for the TDMA.

User Data Area The User Data Area is the logically addressed area of the disc.

Outer Spare Areas (OSA0, OSA1) If spare Clusters are allocated for defect management, then, OSA0 has a maximum size of 196 608 Clusters, allocated in 256 Cluster increments. On DL discs, OSA1 shall be the same size as OSA0.

A TDMA may be allocated in increments of 256 Clusters from any Spare Area. This action reduces the size of the Spare Area by the amount allocated for the TDMA.

4.5.3.2.10 Outer Zone 0 (Lead-out Zone on a SL disc)

On single layer media the Outer Zone has the function of the Lead-out Zone. On dual layer media, the Outer Zone 0 and Outer Zone 1 are layer transition zones between the two layers. The Outer Zone consists of:

INFO3/4 On both layers, INFO3/4 is reserved for defect management and control information.

DCZ The Drive Calibration Zone is reserved for calibration purposes.

Protection Zone 3 On both layers, this zone exists for seek overshoot protection at the disc's outer radius.

4.5.3.3 Logical Structure

4.5.3.3.1 Logical Structure of Single Layer BD-R

The single layer BD disc information zone is contained within a continuous spiral that begins near the inner radius and proceeds until the outer radius. The information zone is divided into three areas: the Lead-in Zone, Data Zone, and Lead-out Zone.

Spare Areas are allocated from the Data Zone, creating three areas within the data zone: Inner Spare Area (ISA0), User Data Area, and Outer Spare Area (OSA0).

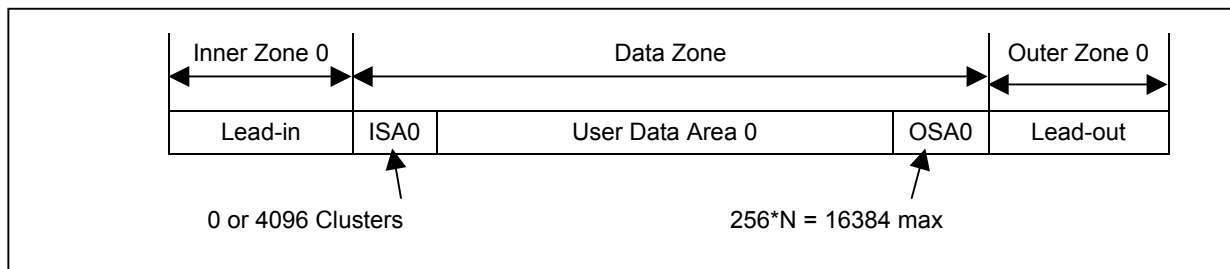

Figure 82 — SL BD-R Information Zone

Regardless of disc diameter, if ISA0 is present, it has a fixed size of 4 096 Clusters. On 120 mm media, OSA0 has a variable size from 0 to 196 608 Clusters, allocated in increments of 256 Clusters. On 80 mm media, OSA0 has a variable size from 0 to 65 536 Clusters, allocated in increments of 256 Clusters.

The defect management and recording management information needs to be updated many times during use. For this purpose a special area is available in the Lead-in/Lead-out Zone called a Temporary Disc Management Area (TDMA). Additional TDMA's **may** be defined to facilitate more space for more updates of the defect and recording management information. These areas **are** useful in the case of many ejects after short recordings or when a more frequent update scheme is desired for more robustness against, for example, power failures.

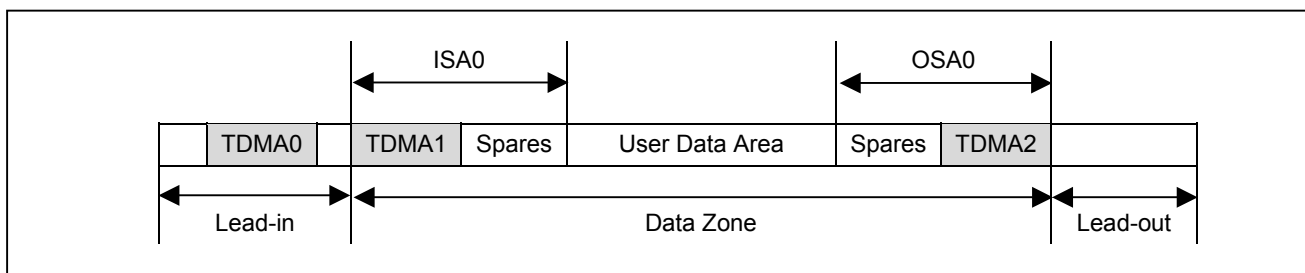

Figure 83 — TDMA Allocation on SL BD-R

TDMA0 is allocated from the Lead-in with 2 048 Clusters.

If necessary, TDMA1 may be allocated from ISA0. **The size of TDMA1 shall be an integral multiple of 256 Clusters. The FORMAT UNIT command maximizes TDMA1 to 15/16 of ISA0.**

If necessary, TDMA 2 may be allocated from OSA0. **The size of TDMA2 shall be an integral multiple of 256 Clusters. The FORMAT UNIT command maximizes TDMA2 to 15/16 of OSA0.**

4.5.3.3.2 Logical Structure of Dual Layer BD-R

The layer 0 information zone of a dual layer BD disc is contained within a continuous spiral that begins near the inner radius and proceeds until the outer radius. The layer 1 information zone of a dual layer disc is contained within a continuous spiral that begins near the outer radius and proceeds until the inner radius. The layer 0 information zone is divided into three areas: the Lead-in Zone, Data Zone 0, and the Outer Zone 0. The layer 1 information zone is divided into three areas: the Outer zone 1, Data Zone 1, and the Lead-out zone. Defect Management areas are intermingled with these zones.

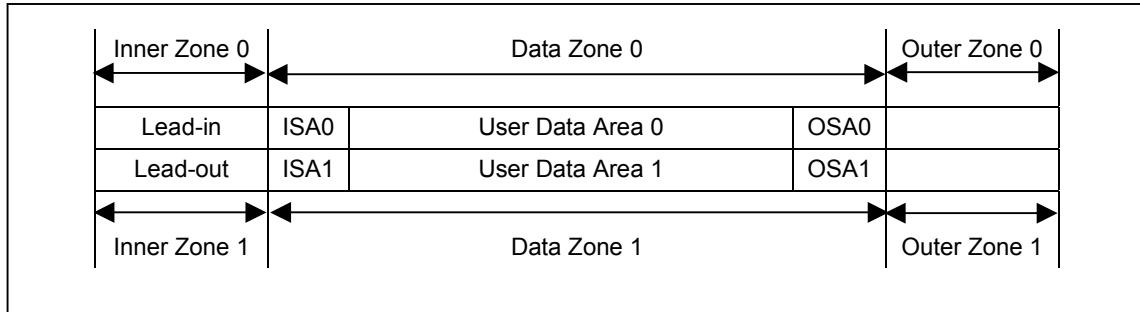

Figure 84 — DL BD-R Information Zones

Regardless of disc diameter, if ISA0 is present, it has a fixed size of 4 096 clusters, and ISA1 has a variable size from 0 to 16 384 Clusters, in increments of 256 Clusters.

On 120 mm media, OSA0 has a variable size from 0 to 196 608 Clusters in increments of 256 Clusters. On 80 mm media, OSA0 has a variable size from 0 to 65 536 Clusters in increments of 256 Clusters. Regardless of disc diameter, OSA1 has the same size as OSA0.

The defect management and recording management information needs to be updated many times during use. For this purpose a special area is available in the Lead-in/Lead-out Zone called a Temporary Disc Management Area (TDMA). Additional TDMA's may be defined to facilitate more space for more updates of the defect and recording management information. These areas are useful in the case of many ejects after short recordings or when a more frequent update scheme is desired for more robustness against, for example, power failures.

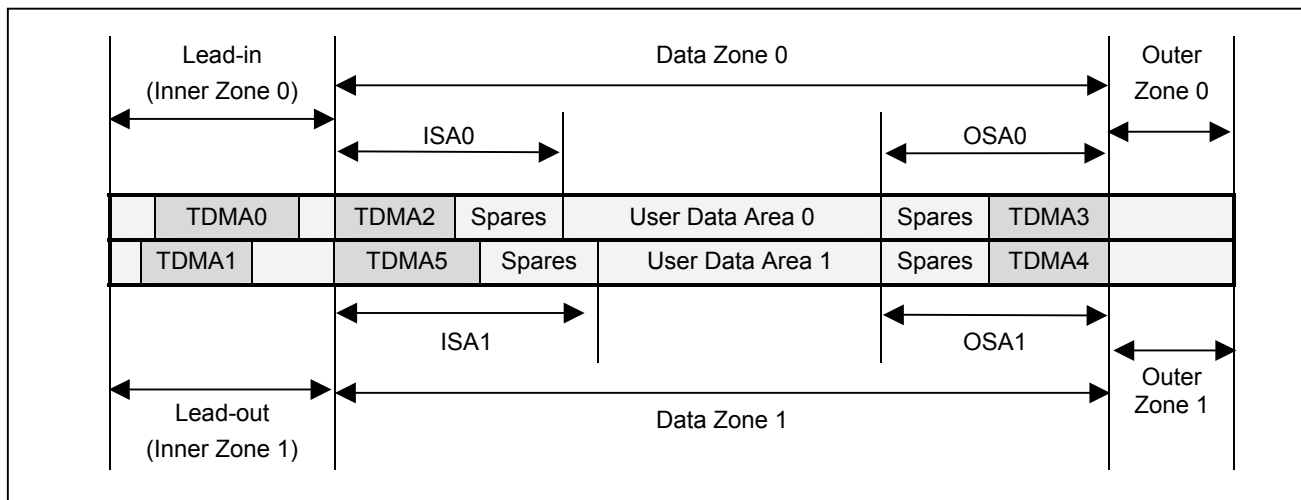

Figure 85 — TDMA Allocation on DL BD-R

TDMA0 is allocated in Inner Zone 0 (Lead-in) and is 2 048 Clusters in size.

TDMA1 is allocated in Inner Zone 1 (Lead-out) and is 2 048 Clusters in size.

TDMA2 may be allocated from ISA0. The size of TDMA2 shall be an integral multiple of 256 Clusters. The FORMAT UNIT command maximizes TDMA2 to 15/16 of ISA0.

TDMA3 may be allocated from OSA0. The size of TDMA3 shall be an integral multiple of 256 Clusters. The FORMAT UNIT command maximizes TDMA2 to 15/16 of OSA0.

TDMA4 may be allocated from OSA1. The size of TDMA4 shall be an integral multiple of 256 Clusters. The FORMAT UNIT command maximizes TDMA3 to 15/16 of OSA1.

TDMA5 may be allocated from ISA1. The size of TDMA5 shall be an integral multiple of 256 Clusters. The FORMAT UNIT command maximizes TDMA5 to 15/16 of ISA1.

4.5.3.4 TDMA and DMA Usage

The TDMA's shall be allocated when the disc is initialized (typically by the execution of the FORMAT UNIT command). Each TDMA shall be filled up contiguously and in the direction of ascending PSNs.

For single layer discs, the minimal TDMA allocation is TDMA0. The TDMA's shall be used sequentially: TDMA0 first, TDMA1 (if it exists) second, and TDMA2 (if it exists) last.

For dual layer discs, the minimal TDMA allocation is TDMA0 and TDMA1. The TDMA's shall be used sequentially: TDMA0 first, TDMA1 second, TDMA2 (if it exists) third, TDMA3 (if it exists) fourth, TDMA4 (if it exists) fifth, and TDMA5 (if it exists) sixth.

To find out quickly which TDMA is currently in use, the first few Clusters of TDMA0 are used as indicators. On a SL disc the first 3 Clusters of TDMA0 are reserved as "current TDMA access indicators". On a DL disc the first 6 Clusters of TDMA0 are reserved as "current TDMA access indicators". These TDMA access indicators are used in the direction of descending PSNs.

The first Cluster of TDMA0 is reserved as an indicator that all DMA zones are written. Thus, if the DMA indicator has been written, the disc is closed (finalized).

SL TDMA access indicators are shown in Figure 86.

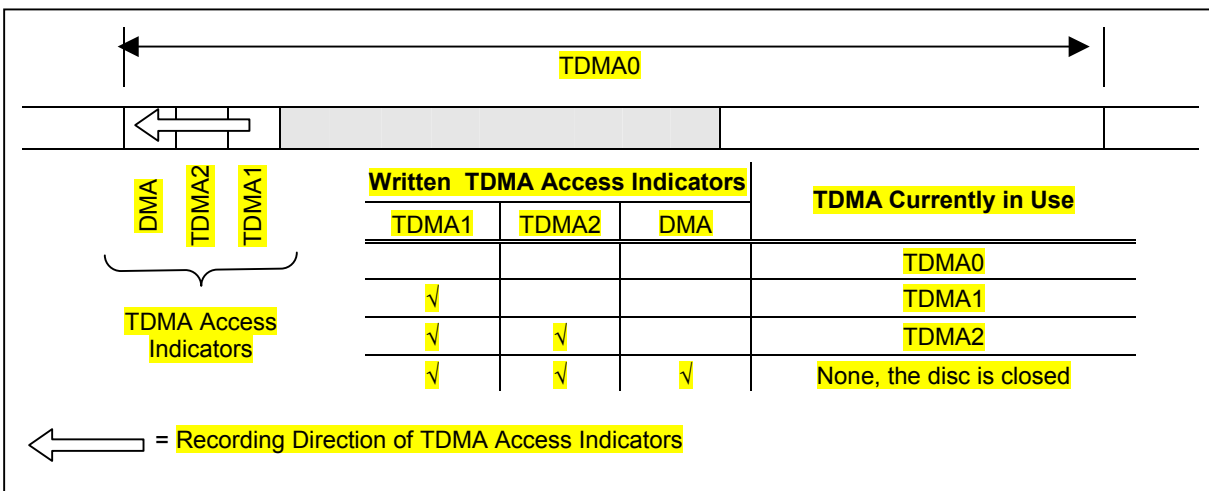

Figure 86 — TDMA Access Indicators on Single Layer Disc

DL TDMA access indicators are shown in Figure 87.

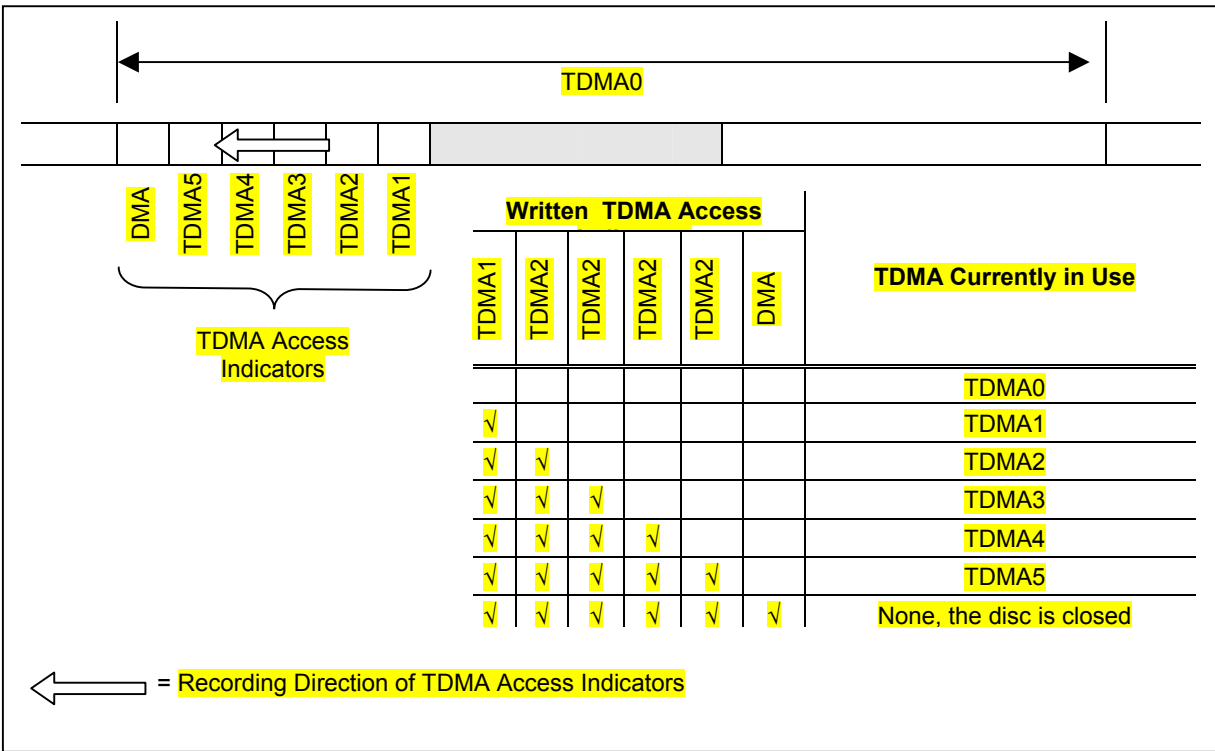

Figure 87 — TDMA Access Indicators on Dual Layer Disc

4.5.3.5 BD-R Recording Models

BD-R has two basic recording modes: SRM (Sequential Recording Mode) and RRM (Random Recording Mode). Pseudo-Overwrite (POW) is defined as an additional capability for SRM.

The default mode for a blank BD-R disc is SRM with no spares allocated. Default mode is established if a blank BD-R is mounted and ready, and the Drive accepts and executes a RESERVE TRACK command, a WRITE (10) command or a WRITE (12) command.

Otherwise, specific recording mode is selected by use of the FORMAT UNIT command. If spares are to be allocated, the FORMAT UNIT command is used to select either default size or actual size of spare area.

Once the recording mode has been established, it is not changeable.

4.5.3.5.1 Random Recording Mode (RRM)

The Random Recording Mode (RRM) is an application of a Random Recording model that is similar to the Write-Once device model. A RRM formatted disc may be randomly recorded in Clusters.

The written status of user data area Clusters is maintained in a structure called the Space Bitmap. The Space Bitmap contains one bit per Cluster in Logical Address order. If a bit is set to zero, the associated Cluster has never been written. If the bit is set to one, the associated Cluster has been recorded.

Implementing RRM in a Drive is optional.

4.5.3.5.2 Sequential Recording Mode (SRM)

4.5.3.5.2.1 General

The Sequential Recording Mode (SRM) is an application of the Track/Session model that has been previously defined for CD and DVD. In order to maintain a structure that is consistent with the historical models, all definitions are made with respect to logical addressing.

During the time that the Track/Session status of the disc is dynamic (i.e. when the disc is not finalized), status and boundary information about Tracks/Sessions are stored in a TDMS (Temporary Disc Management Structure). TDMS updates are made serially in areas called Temporary Disc Management Areas (TDMAs). When the disc is finalized (i.e. no further changes are permitted), all pending TDMS updates shall be written, and the most recent copy of the TDMS is copied into each of the DMAs (4 on SL and 8 on DL) on the disc.

4.5.3.5.2.2 Definitions

4.5.3.5.2.2.1 Logical Blocks

A Logical Block is the smallest logically addressable unit of data that is readable by the Host. For BD-R, the Logical Block size is 2 048 bytes. This value is specified in the Logical Block Size field in the Random Readable Feature Descriptor.

4.5.3.5.2.2.2 Recordable Units

A recordable unit is the smallest physically writable collection of contiguous Logical Blocks. For BD-R the recordable unit size is 32 Logical Blocks, one Cluster. This value is specified in the Blocking field of the Random Writable Feature Descriptor.

4.5.3.5.2.2.3 Logical Track: Sequential Recording Range (SRR)

A Logical Track is a set of sequential recordable units. Logical Tracks are numbered consecutively, starting with number one. On BD-R, the Logical Track is defined as a Sequential Recording Range (SRR). The physical extents of each SRR and the status of each SRR is defined in the SRR Information (SRR) structure. The SRR is a structure in the TDMS that is maintained in the Temporary Disc Management Areas (TDMA).

BD-R Logical Tracks bounds are defined only in the SRR. No overhead blocks are used in the definition of a Logical Track on BD-R.

4.5.3.5.2.2.3.1 Logical Track Starting Address

The LBA of the first Logical Block of the Logical Track is the starting address of the Logical Track.

4.5.3.5.2.2.3.2 Logical Track Length

The number of Logical Blocks in the Logical Track is the track length. Since a BD-R Logical Track is a collection of Clusters, this value is an integral multiple of 32.

4.5.3.5.2.2.3.3 *Next Writable Address (NWA)*

The Host is only permitted to record a Logical Track sequentially, beginning with its starting address. To facilitate this, the Drive maintains a Next Writable Address (NWA) for each open Logical Track. There is at most one NWA in a Logical Track.

If the Logical Track is blank, then the NWA is initialized to the starting address of the Logical Track. The NWA is advanced by the number of LBAs written in each write command after each write command has terminated.

Since writes may be buffered, the NWA may not always be at a Cluster boundary. If buffer synchronization is forced (e.g. SYNCHRONIZE CACHE command), all buffered data is written to the disc. If the last buffered block is not sector 31 of a Cluster, then zero padding shall be added to the end of the Cluster prior to writing.

4.5.3.5.2.2.3.4 *Last Recorded Address (LRA)*

The last Cluster addressed by a WRITE command may be written with 1 to 32 Logical Blocks contain Host supplied data. The Last Recorded Address (LRA) is the LBA of the last Logical Block of the Cluster that contains Host supplied data. LRA is not valid when POW is enabled.

4.5.3.5.2.2.3.5 *Blank Logical Track*

If every Logical Block in a Logical Track is blank, the Logical Track is blank. The NWA of a blank Logical Track is the Logical Track starting address.

4.5.3.5.2.2.3.6 *Open Logical Track*

The SRRl contains a list of open SRRs. A Logical Track is open if it is in the list. In order to be in the list of open Logical Tracks: $\text{Start Address} + \text{Track Length} - 1 > \text{NWA}$. The SRRl open SRR list is limited to 16 open SRRs.

4.5.3.5.2.2.3.7 *Closed Logical Track*

A Logical Track is closed when the Logical Track is defined, but not in the SRRl list of open Logical Tracks. The Host may request that a Logical Track be closed by sending the CLOSE TRACK/SESSION command. A Logical Track becomes closed when:

1. All of its Logical Blocks have been written, or
2. When the Host has requested that the Logical Track be closed.

When a Logical Track is closed, the NWA is no longer valid for appending new data.

If the invisible Logical Track, numbered N, is partially recorded and a close is requested by the Host, the Logical Track bounds are specified to include only the recorded Logical Blocks and a new, blank invisible Logical Track is created with Logical Track number N+1.

If a Logical Track is closed, it may contain blank Clusters. If the Host chooses to read a sector from a blank Cluster in a closed Logical Track, the Drive shall return all zeros in place of sector data.

4.5.3.5.2.2.4 *Session*

A session is a collection of contiguous Logical Tracks. The bounds of a session are defined in the SRRl. Unlike CD and DVD sessions, the BD-R SRM session is defined only by the SRRl. Consequently, there is neither a session lead-in nor a session lead-out. Sessions are numbered consecutively, starting with session one.

4.5.3.5.2.2.4.1 *Open Session*

A session is open if any of the Logical Tracks within the session are open.

4.5.3.5.2.2.4.2 *Closed Session*

A session is closed if all of the Logical Tracks within the session are closed. Once a session is closed, it is not permitted to add new Logical Tracks.

4.5.3.5.2.2.4.3 *Finalized (Closed) Disc*

A disc is finalized when all sessions are closed and each final DMS is recorded in the appropriate DMA. Since the DMS on layer 0 is different from the DMS on layer 1, the process for dual layer media is different from the process for single layer media.

Once each DMS is recorded in the appropriate DMA, it is not necessary to record any other part of the Inner or Outer zones.

4.5.3.5.2.3 Logical to Physical Addressing

The logical to physical address mapping operates differently on layer 0 and layer 1.

On layer 0, the user data area begins at some physical address, K, where K is the PSN of the first block of the first Cluster after ISA0. K+J₀ is the PSN of the first block of the first Cluster of OSA0.

The primary Logical to physical mapping (LtoP) is defined as: For 0 ≤ N ≤ J₀-1, LtoP(N) = N+K. Otherwise, N is not in the range of the mapping. See Figure 88.

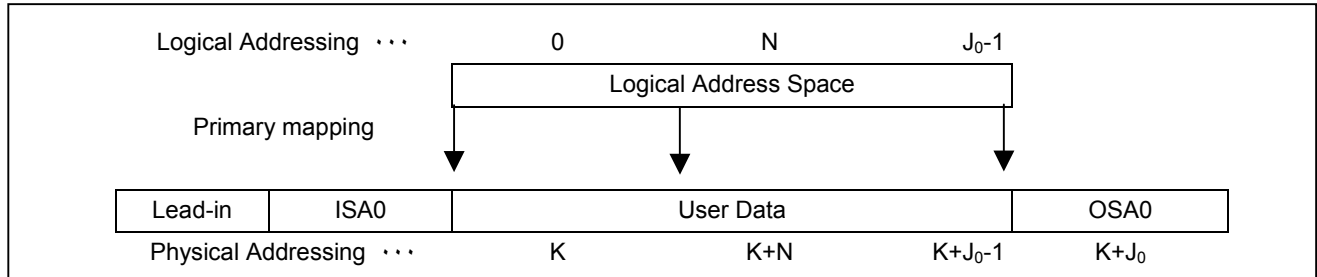

Figure 88 — Logical to Physical Addressing on Single Layer

If layer 1 is present, the disc's user data zone continues on layer 1 with the first block of the first Cluster after OSA1, J₁. The user data zone continues until the first block of the first Cluster of ISA1, at C. The primary Logical to physical mapping (LtoP) is extended to include layer 1:

$$LtoP(N) = \begin{cases} N+K & \text{when } 0 \leq N \leq J_0-1. \\ (N-J_0)+J_1 & \text{when } J_0 \leq N \leq C-1. \end{cases}$$

See Figure 89.

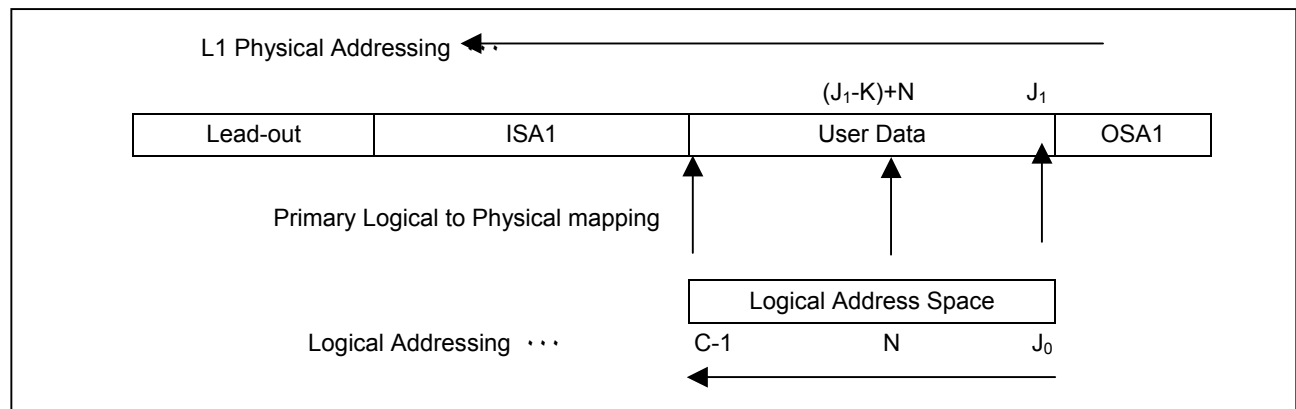

Figure 89 — Logical to Physical Addressing on Dual Layer

If the disc is formatted with defect management, and if upon recording, LtoP(N) is found to be defective, the defect replacement mapping is applied to map LtoP(N) to a Cluster in a spare area.

4.5.3.5.2.4 Status after Formatting a Blank BD-R

If a blank BD-R disc is formatted in SRM, the User Data Zone consists of one open session with one open Logical Track (SRR). This Logical Track is the invisible Logical Track. As shown in Figure 90, the number of the track is 1, its start address is LBA = 0, and its length is the size of the User Data Zone (CAP). The Next Writable Address (NWA) for Logical Track 1 is LBA = 0.

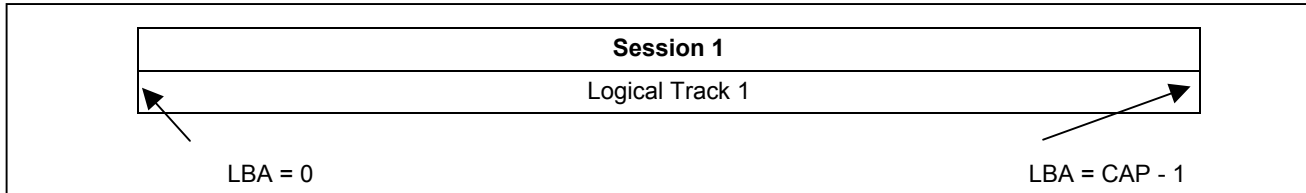

Figure 90 — Status of a BD-R Disc After Formatting in SRM

If a WRITE command is issued to the Drive, the Starting LBA must be equal to the NWA. If the starting LBA of a WRITE command is not the NWA of some Logical Track, then the WRITE command shall be terminated with CHECK CONDITION status, and the sense shall be set to indicate ILLEGAL REQUEST/INVALID ADDRESS FOR WRITE.

4.5.3.5.2.5 Creating Additional Logical Tracks

The RESERVE TRACK command may be used to define a fixed length Logical Track from the invisible track. The length of the new track, N2, is defined by the execution of the RESERVE TRACK command using parameters from the CDB. The length is specified as a number of Logical Blocks, but the RESERVE TRACK command performs the creation of the new track as a integral number of Clusters. Figure 91 shows the newly defined track is track 1, its start address is LBA = 0, its length is N2, and its NWA is 0. The invisible track is track 2, its start address is N2, its length is the remaining size of the User Data Area, and its NWA = N2.

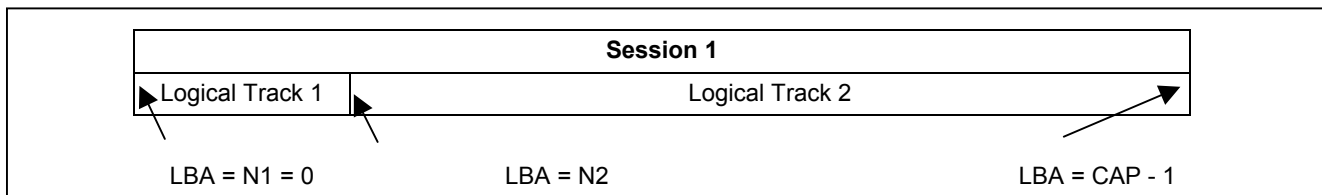

Figure 91 — Status of BD-R Disc After First RESERVE TRACK Command

The RESERVE TRACK command, may be used iteratively to define additional Logical Tracks from the invisible track as shown in Figure 92.

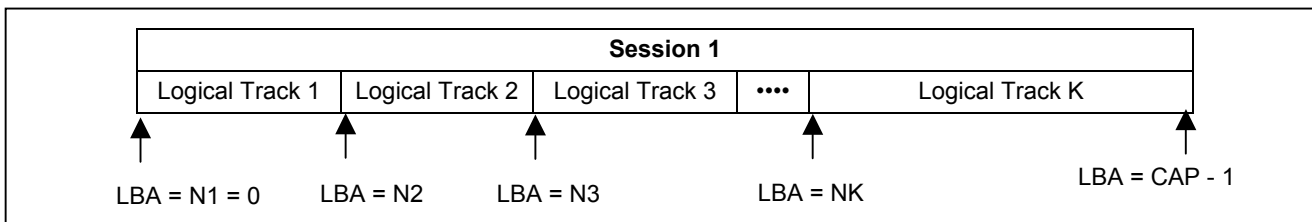

Figure 92 — Status of BD-R Disc Multiple RESERVE TRACK Commands

It is also possible to split an open Logical Track into two Logical Tracks. The split shall occur at the start of a Cluster within the Logical Track that is at or after the NWA. If the split occurs at the NWA, then the first of the two new tracks is created closed and the second is blank.

4.5.3.5.2.6 Creating New Sessions

When a session is closed and the disc is not finalized, a new session is created that contains only the invisible Logical Track. See Figure 93.

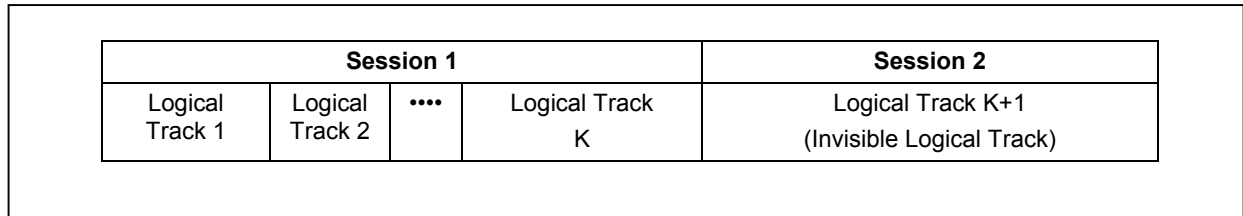

Figure 93 — Status of BD-R Disc after Closing Session 1

The process of creating session 2 **may** be iterated as with session 1 until the disc is finalized.

4.5.3.5.3 Defect Management

Defect management is used to solve problems related to areas on the disc that may become defective or unreliable due to damage or contamination. The Drive redirects the recording of the involved user data to another location, called spare areas. Information about these redirections is stored in the Defect List.

In order to ensure data integrity, it is recommended that WRITE (10) data be verified during the write process when the Defect Management feature is current. This is also recommended that WRITE (12) data be verified except when either VNR is set to one or Streaming is set to one.

4.5.3.5.4 Pseudo-OverWrite (POW)

Pseudo-Overwrite (POW) is used to make Write-Once media behave like Rewritable media. When the Host requests recording of user data on an already recorded area, then the Drive redirects the recording of the involved user data to an alternative location. Such Logical Overwrites (writing to the same LBA, but actually recording at a reassigned PSN) are treated in the same way as defects, i.e. information about the redirections is stored in the Defect List.

4.5.3.5.4.1 POW on SRM

When a SRM disc has the POW capability, the Logical Overwrite of a Cluster is redirected to the NWA of some open Logical Track. POW recording is permitted on the SRM logical structure:

- A SRM disc with POW shall be initialized by the formatting process as a single session disc with a single Logical Track.
- POW is not permitted on a finalized disc, because no NWA is valid.
- If the disc is not finalized, POW is permitted in both open and closed Logical Tracks.
- On SRM, each WRITE command shall start and end within the same Logical Track.

When POW is performed, it is recommended that the redirection be to a Cluster with NWA that is near the addressed Cluster. The actual algorithm for selecting the physical Cluster for the redirection is vendor specific.

4.5.3.5.4.2 Orphans

There is exactly one NWA for each Logical Track. The NWA is a LBA that follows the physical usage of the Logical Track rather than the Logical usage.

When a POW is applied to a Logical Block, the relocation occurs at the NWA of some open Logical Track. An entire Cluster must be used in the relocation, so the NWA is advanced by 32. Prior to the POW, 32 LBAs were associated with the Cluster beginning at the NWA. After the POW operation, those 32 LBAs are no longer available for append. The LBAs have not been lost, but they may be written only via another POW. Until written, these LBAs are called Orphans.

An orphan LBA has no associated logical content and consequently represents a blank sector. If a READ command is issued to an orphan LBA, the Drive returns the data that has been relocated to the physical location that was originally associated with the orphan LBAs.

4.5.3.5.4.3 Closed Logical Tracks with Blank Clusters

Although a closed Logical Track has no valid NWA, it may contain blank Clusters. A POW to a Logical Block in a closed Logical Track may require a read-modify-write operation. Consequently, determination of blankness is necessary. If a POW of a blank Cluster is indicated, then any Logical Blocks not provided by the Host shall be zero padded prior to writing. Due to the inefficiency, it is recommended to avoid POWing blank Clusters in closed tracks.

4.5.3.6 Examples of SRM and SRM+POW

For simplicity, the examples are described for single layer media.

4.5.3.6.1 Initialize the Disc as SRM+POW

A blank BD-R disc is formatted as SRM+POW. The PBA of the first block of the first Cluster after ISA0 is K. The PBA of the first block of the first Cluster of OSA0 is K+C, where C is the number of blocks in the User Data Area.

The READ TRACK INFORMATION command for Logical Track 1 returns:

Start address = 0, NWA = 0 and free blocks = C.

The READ CAPACITY command returns C-1 as the last addressable logical block on the media.

See Figure 94.

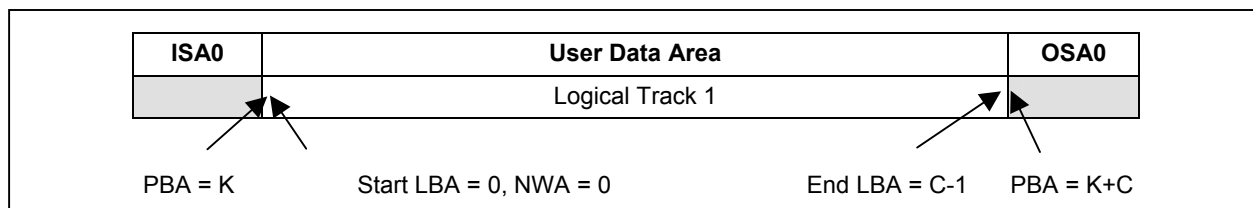

Figure 94 — Status after Formatting SRM+POW

4.5.3.6.2 Create a Small Logical Track, Write it, and Close it

The RESERVE TRACK command is used to split the single, invisible track at LBA = C-256. This creates one large track, C-256 blocks in length, and one small track, 256 blocks in length.

The READ DISC INFORMATION command (requesting standard disc information) shall show one track prior to the RESERVE TRACK command and two tracks afterward.

A WRITE (10) command sends 256 blocks of data starting at the NWA (C-256) of Logical Track 2.

Logical Track 2 is closed because the Logical Track has been completely written.

The READ TRACK INFORMATION command for Logical Track 1 returns:

Start address = 0, NWA = 0 and free blocks = C-256.

The READ TRACK INFORMATION command for Logical Track 2 returns:

Start address = C-256, NWA is not valid, and free blocks = 0.

See Figure 95.

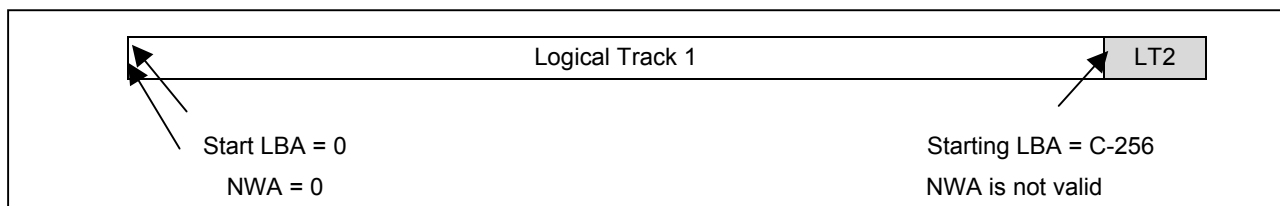

Figure 95 — Create, Write, and Close Small Outer Logical Track

4.5.3.6.3 Split Logical Track 1

The RESERVE TRACK command is used to split Logical Track 1 into Logical Tracks 1 and 2.

The READ TRACK INFORMATION command for Logical Track 1 returns:

Start address = 0, NWA = 0 and free blocks = 320.

The READ TRACK INFORMATION command for Logical Track 2 returns:

Start address = 320, NWA = 320 and free blocks = C-576.

See Figure 96.

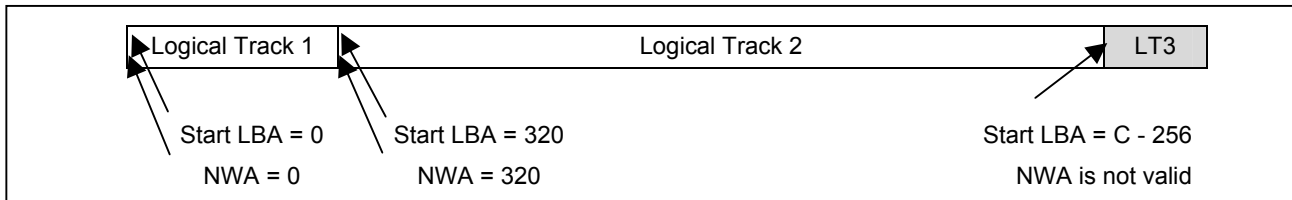

Figure 96 — Status after Splitting Logical Track 1

4.5.3.6.4 Split Logical Track 2

The RESERVE TRACK command is used to split Logical Track 2 into Logical Tracks 2 and 3.

The READ TRACK INFORMATION command for Logical Track 1 returns:

Start address = 0, NWA = 0 and free blocks = 320.

The READ TRACK INFORMATION command for Logical Track 2 returns:

Start address = 320, NWA = 320 and free blocks = 320.

The READ TRACK INFORMATION command for Logical Track 3 returns:

Start address = 640, NWA = 640 and free blocks = C-896.

See Figure 97.

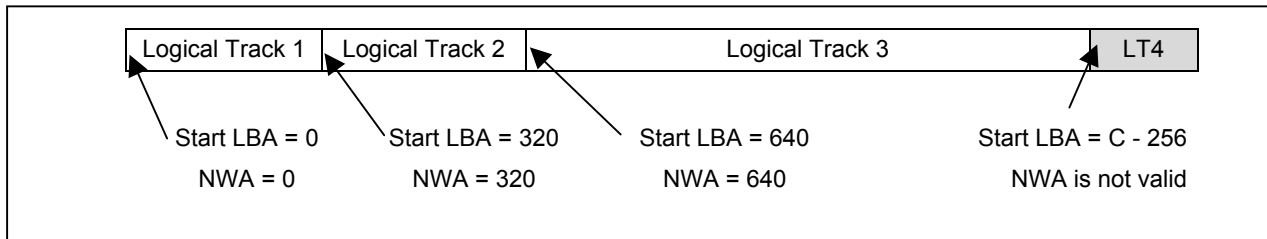

Figure 97 — Status after Splitting Logical Track 2

4.5.3.6.5 Write to Each Logical Track

A WRITE (10) command sends 160 blocks of data starting at the NWA (0) of Logical Track 1.
 A WRITE (10) command sends 160 blocks of data starting at the NWA (320) of Logical Track 2.
 A WRITE (10) command sends 32 blocks of data starting at the NWA (640) of Logical Track 3.
 The READ TRACK INFORMATION command for Logical Track 1 returns:
 Start address = 0, NWA = 160 and free blocks = 160.
 The READ TRACK INFORMATION command for Logical Track 2 returns:
 Start address = 320, NWA = 480 and free blocks = 160.
 The READ TRACK INFORMATION command for Logical Track 3 returns:
 Start address = 640, NWA = 672 and free blocks = C-928.
 See Figure 98. All 3 Logical Tracks are open.

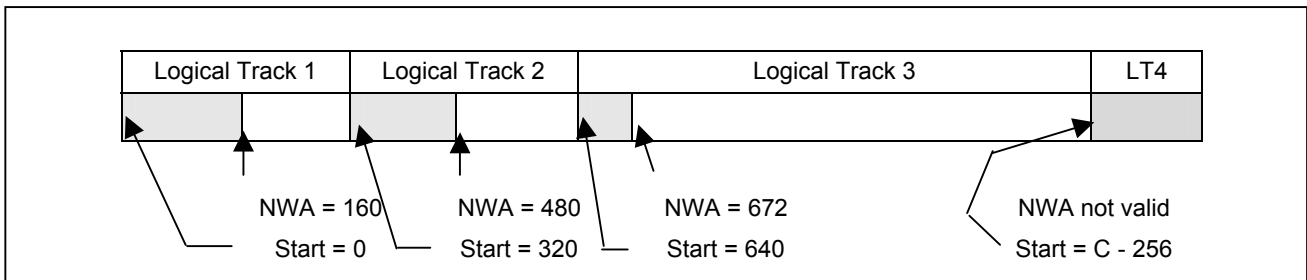

Figure 98 — Status after Writing to each Logical Track

4.5.3.6.6 POW a Logical Block in Logical Track 1

A WRITE (10) command writes one block of user data at LBA = 128.
 This Logically OverWrites sector 128. The Cluster beginning at LBA 128 is read internally, the new data replaces the data for sector 128, and the Cluster is rewritten at the Logical Track 1 NWA (160). The NWA is now 192.
 The READ TRACK INFORMATION command for Logical Track 1 returns:
 Start address = 0, NWA = 192 and free blocks = 128.

In
 Figure 99 note that:

LBA 160, ..., 191 are now Orphans.
 The logical length of Logical Track 1 is 320, however, the number of written LBAs in Logical Track 1 (160) plus the free blocks of Logical Track 1 (128) is at most 288.

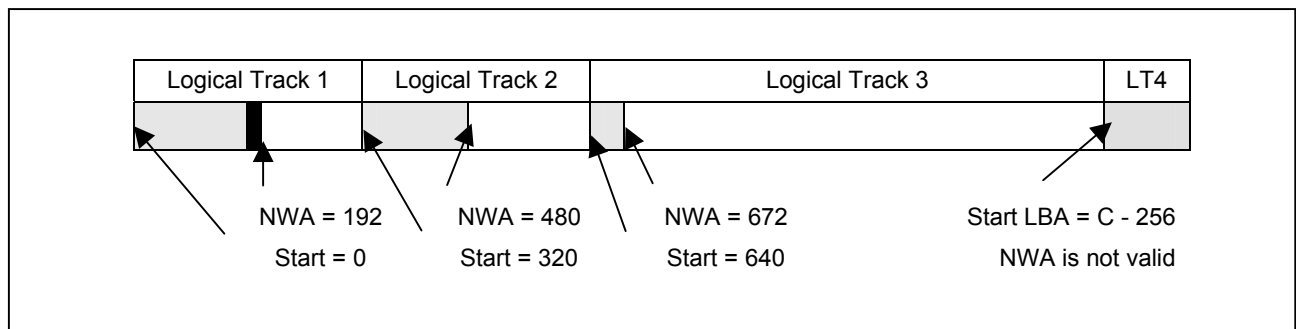

Figure 99 — Status after LOW to LBA 256

4.5.3.6.7 Complete Writing Logical Track 1, POW LBA = 128 a Second Time

A WRITE (10) command sends 128 blocks of data starting at the NWA (192) of Logical Track 1.

A WRITE (10) command writes one block of user data at LBA = 128.

This Logically OverWrites sector 128. The Cluster beginning at LBA 128 is read internally, the new data replaces the data for sector 128, and the Cluster is rewritten at the Logical Track 2 NWA (480). The NWA is now 512. It is also permitted to POW to the NWA of another track.

The READ TRACK INFORMATION command for Logical Track 1 returns:

Start Address = 0, NWA is not valid, and free blocks = 0. Logical Track 1 is closed.

The READ TRACK INFORMATION command for Logical Track 2 returns:

Start address = 320, NWA = 512 and free blocks = 128.

The READ TRACK INFORMATION command for Logical Track 3 returns:

Start address = 640, NWA = 672 and free blocks = C-928.

See Figure 100.

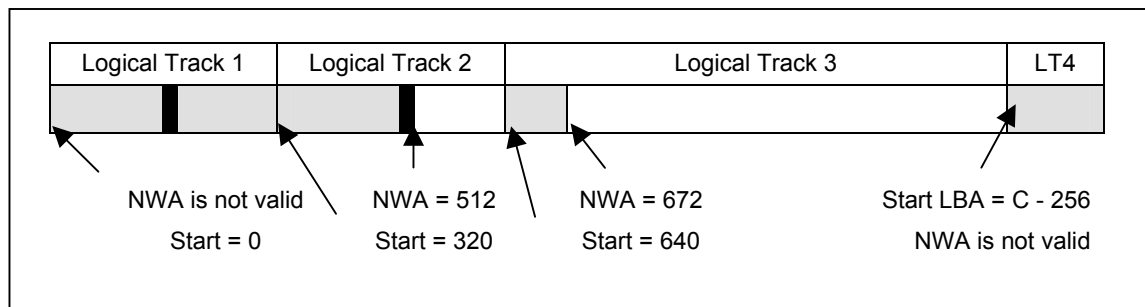

Figure 100 — Status after writing to Logical Track 1

4.5.3.6.8 Use Orphaned LBAs via POW

A WRITE (10) command writes 32 blocks of user data at LBA = 160.

This recovers the LBAs that were orphaned by a previous LOW. Using orphaned LBAs requires a new POW. The new data from the Host is written at the Logical Track 2 NWA (512). The NWA is now 544.

The READ TRACK INFORMATION command for Logical Track 1 returns:

Start Address = 0, NWA is not valid, and free blocks = 0. Logical Track 1 is closed.

The READ TRACK INFORMATION command for Logical Track 2 returns:

Start address = 320, NWA = 544 and free blocks = 96.

The READ TRACK INFORMATION command for Logical Track 3 returns:

Start address = 640, NWA = 672 and free blocks = C-928.

See Figure 101.

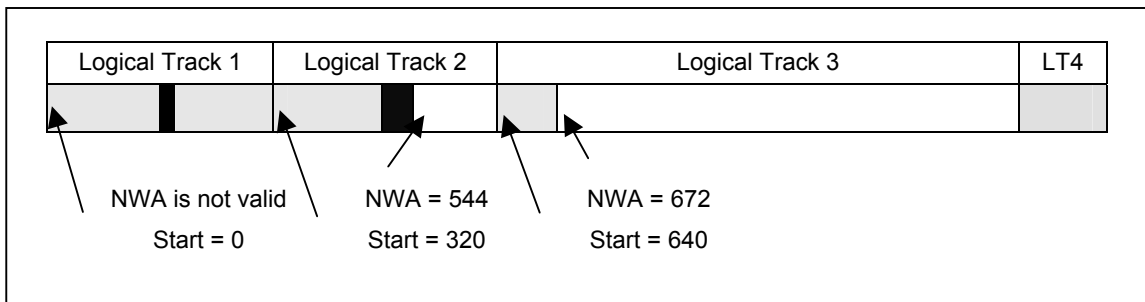

Figure 101 — Status after LOW of LBA 256

LBAs 512,....,543 are now orphaned.

4.5.3.6.9 The Expanding Orphanage

Each time a POW is performed, 32 orphaned LBAs are created. Orphan LBAs **may** be used, but since it is only possible to do so with a POW, new orphan LBAs are created in the process. Consequently, the number of Orphan LBAs is a monotonically increasing function.

In 4.5.3.6.6, Orphan LBAs 160 through 191 were created by the POW of LBA 128.

In 4.5.3.6.7, Orphan LBAs 480 through 511 were created by the POW of LBA 128.

In 4.5.3.6.8, Orphan LBAs 512 through 543 were created when Orphan LBAs 160 through 191 were used.

In order to provide a complete LBA space, recording at any unused LBA is permitted. However, using orphaned LBAs requires additional defect list entries and causes additional seeking during sequential LBA accesses.

Due to the inefficiency of media use and degradation of performance, it is preferred that the Host allocation algorithms avoid using orphan LBAs. This **may** be done by only permitting writes to start at some Logical Track's NWA.

4.5.4 BD-RE

4.5.4.1 Overview

BD-RE disc is a rewritable media with 3 possible capacities per layer (23.3 GB, 25.0 GB, and 27.0 GB). BD has a single continuous groove on each layer and may consist of one or two layers. Dual layer media is structured only as opposite-track-path.

The Host access model for BD-RE is based upon a random access model. BD-RE is Formattable. Hardware defect management is mandatory. The size of the spare areas is selectable according to [BD-Ref3].

4.5.4.2 Track Structure

The single layer BD-RE disc information area is contained within a continuous spiral that begins near the inner radius and proceeds until the outer radius. The information area is divided into three areas: the Lead-in Area, Data Area, and Lead-out Area.

Spare Areas are allocated from the Data Zone, creating three areas within the data zone: Inner Spare Area (ISA0), User Data Area, and Outer Spare Area (OSA0).

If ISA0 is present, it has a fixed size of 2048 Clusters. OSA0 has a variable size from 0 to 16384 Clusters, allocated in increments of 256 Clusters. Consequently, OSA0 size in Clusters = $N \times 256$ Clusters, where $0 \leq N \leq 64$. See Figure 102.

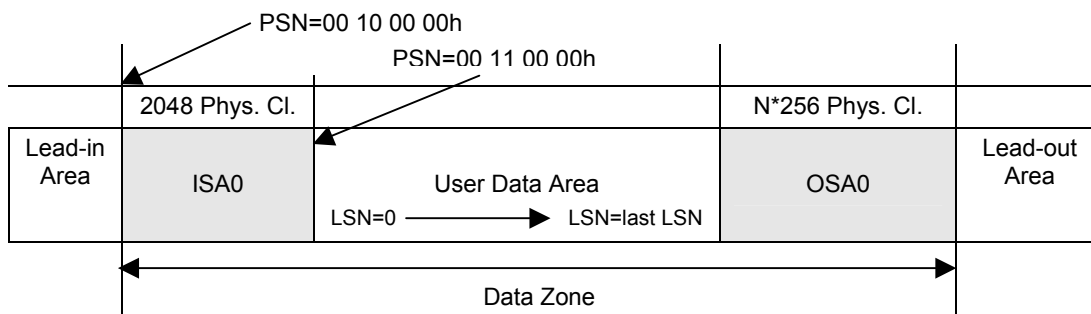

Figure 102 — Layout of Single Layer BD Disc

On a dual layer BD disc, the layer 0 information zone of a dual layer BD disc is contained within a continuous spiral that begins near the inner radius and proceeds until the outer radius. The layer 1 information zone of a dual layer disc is contained within a continuous spiral that begins near the outer radius and proceeds until the inner radius. The layer 0 information zone is divided into three areas: the Lead-in Zone, Data Zone 0, and the Outer Zone 0. The layer 1 information zone is divided into three areas: the Outer zone 1, Data Zone 1, and the Lead-out zone.

Spare Areas are allocated from the Data Zones, creating three areas within each data zone: Inner Spare Areas (ISA0 and ISA1), User Data Area, and Outer Spare Areas (OSA0 and OSA1).

If ISA0 is present, it has a fixed size of 2048 clusters. OSA0 has a variable size from 0 to 8192 Clusters in increments of 256 Clusters. OSA0 size in Clusters = $N \times 256$ Clusters, where $0 \leq N \leq 32$. OSA1 has the same size as OSA0. ISA1 has a variable size from 0 to 16 384 Clusters, in increments of 256 Clusters. Consequently, ISA1 size in Clusters = $L \times 256$ Clusters, where $0 \leq L \leq 64$. See Figure 103.

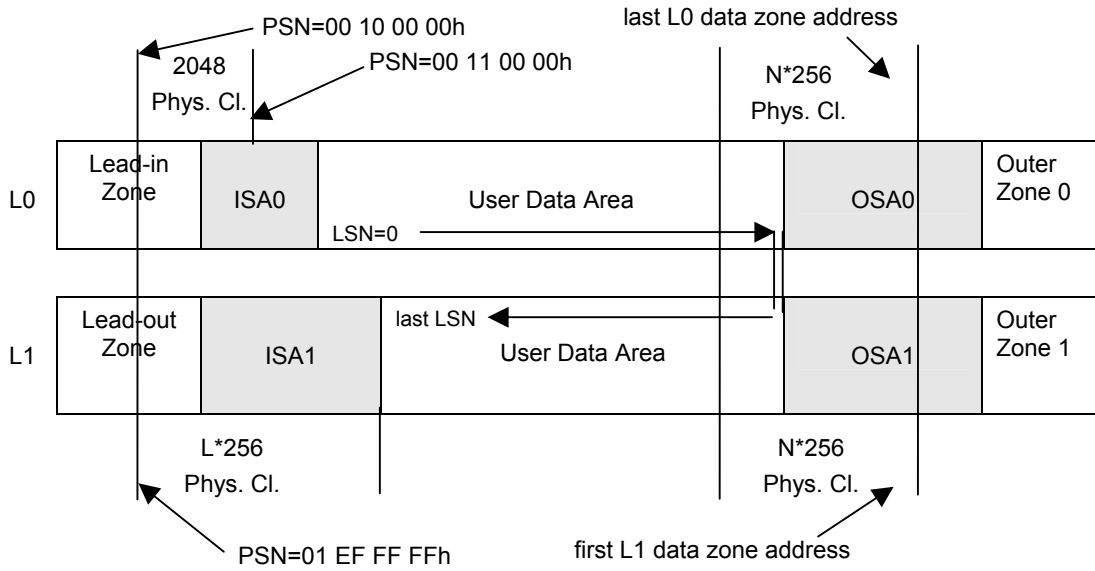

Figure 103 — Layout of Dual Layer BD-RE Disc

4.5.4.3 The Information Zone

The information zone of a dual layer BD-RE disc (Figure 78) is the accessible grooves.

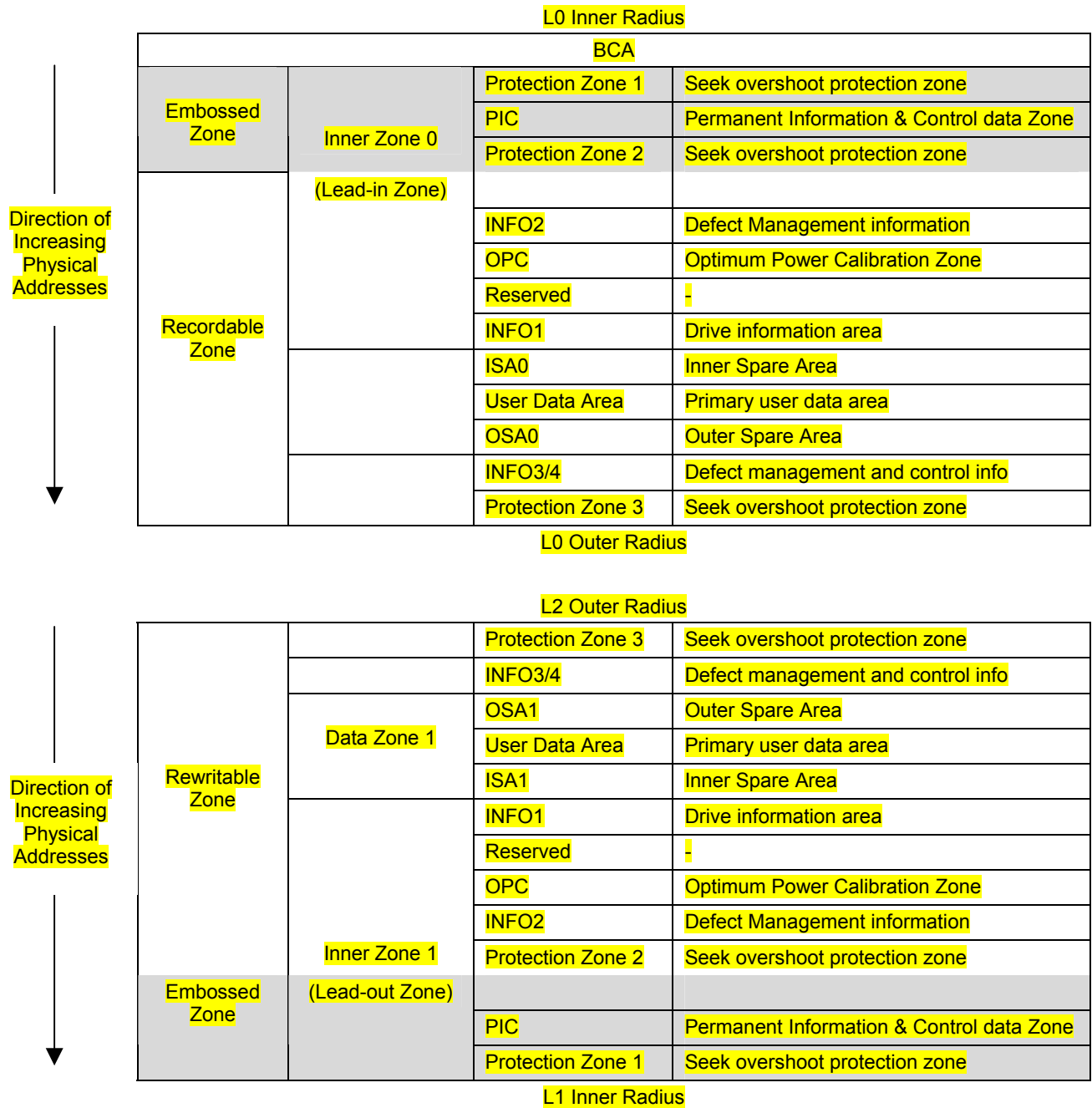

Figure 104 — BD-RE Information Zone

Each layer of the Information Zone is divided into an embossed (pre-recorded) high frequency modulated (HFM) area and a rewritable area. The rewritable area of layer 0 is divided into a lead-in zone, a data zone, and a Outer Area. On single layer media, the outer area is the disc lead-out zone. On dual layer media each outer area is a layer transition area.

4.5.4.3.1 Burst Cutting Area

The BCA is used to add information to the disc after completion of the manufacturing process. The BCA-code is typically written by a high-power laser system in the case of Recordable discs.

4.5.4.3.2 Embossed HFM Zone

The Embossed HFM Zone consists of:

Permanent Information & Control data zone (PIC)	On layer zero, this embossed zone contains disc information that includes, but is not restricted to: <ol style="list-style-type: none"> 1. Physical media class and version 2. Physical address of the start of the Data Zone 3. Physical address of the start of the outer zone (if this is a single layer media, this is the lead-out) 4. Number of layers 5. Recording Density 6. Write power information <p>On layer 1 this embossed zone contains a copy of the layer 0 information, but the physical addresses refer to physical addresses on layer 1.</p>
---	--

4.5.4.3.3 Inner Zone 0/Inner Zone 1 (Lead-in Zone/Lead-out Zone)

An Inner Zone consists of:

Protection Zone 2	On both layers, this zone buffers the rewritable area from the embossed zone.
INFO2	On both layers, INFO2 is reserved for defect management information and PAC storage.
Optimum Power Calibration (OPC) Zone	On both layers, the OPC Zone is reserved for testing and calibration.
INFO1	On both layers, this zone is reserved for drive specific information and PAC storage.

4.5.4.3.4 Data Zone

The Data Zone consists of:

Inner Spare Areas (ISA0, ISA1)	If spare Clusters are allocated for defect management, then ISA0 is allocated with 4 096 Clusters. If spare Clusters are allocated for defect management, ISA1 is an area available for spare area allocation in 256 Cluster increments. Any part of the data zone that is not allocated for spare Clusters is part of the User Data Zone.
User Data Zone	The User Data Zone is the logically addressed area of the disc.
Outer Spare Areas (OSA0, OSA1)	If spare Clusters are allocated for defect management, OSA0 is an area available for spare area allocation in 256 Cluster increments. OSA1 is the same size as OSA0.

4.5.4.3.5 Lead-out Zone/Outer Zone 0/Outer Zone 1

The Outer Zone consists of:

INFO3/4	On both layers, INFO3/4 is reserved for defect management and control information.
Protection Zone 3	On both layers, this zone exists for seek overshoot protection at the disc's outer radius.

4.5.5 Physical Track Structure

BD-RE physical track structure has the general BD disc structure with additional format entities defined uniquely for BD-RE.

Spare Areas are allocated from the Data Zone, creating three areas within the Data Zone: Inner Spare Area (ISA0), User Data Zone, and Outer Spare Area (OSA0).

If ISA0 is present, it has a fixed size of 4096 Clusters. OSA0 has a variable size from 0 to 16384 Clusters, allocated in increments of 256 Clusters. Consequently, OSA0 size in Clusters = $N * 256$ Clusters, where $0 \leq N \leq 64$. See Figure 102.

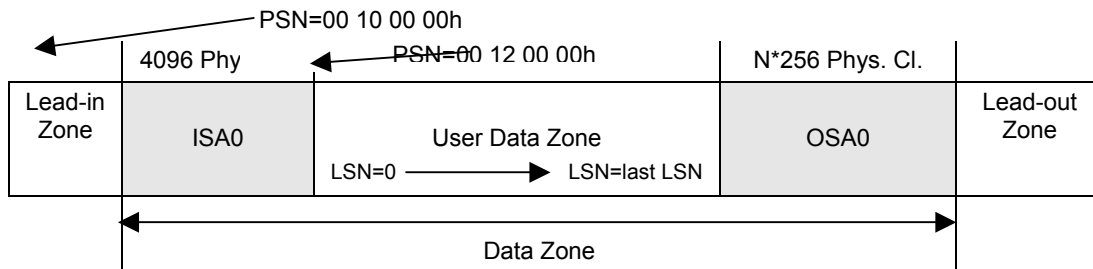

Figure 105 — Layout of Single Layer BD-RE Disc

The layer 0 information zone of a dual layer BD-RE disc is contained within a continuous spiral that begins near the inner radius and proceeds until the outer radius. The layer 1 information zone of a dual layer disc is contained within a continuous spiral that begins near the outer radius and proceeds until the inner radius. The layer 0 information zone is divided into three areas: the Lead-in Zone, Data Zone 0, and the Outer Zone 0. The layer 1 information zone is divided into three areas: the Outer zone 1, Data Zone 1, and the Lead-out zone.

Spare Areas are allocated from the Data Zones, creating three areas within each data zone: Inner Spare Areas (ISA0 and ISA1), User Data Zone, and Outer Spare Areas (OSA0 and OSA1).

If ISA0 is present, it has a fixed size of 4096 Clusters. OSA0 has a variable size from 0 to 8192 Clusters in increments of 256 Clusters. OSA0 size in Clusters = $N * 256$ Clusters, where $0 \leq N \leq 32$. OSA1 has the same size as OSA0. ISA1 has a variable size from 0 to 16 384 Clusters, in increments of 256 Clusters. Consequently, ISA1 size in Clusters = $L * 256$ Clusters, where $0 \leq L \leq 64$. See Figure 103.

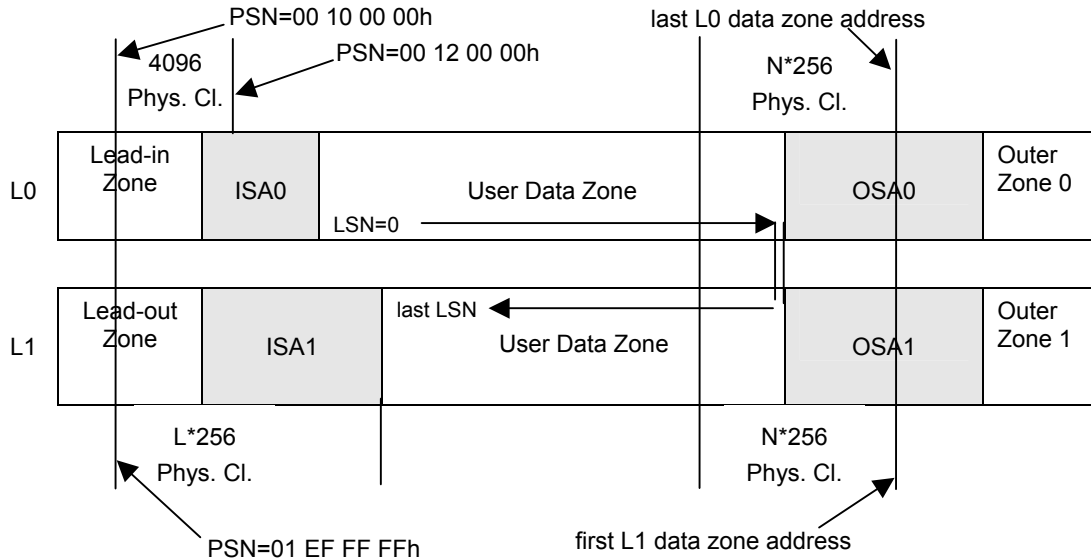

Figure 106 — Layout of Dual Layer BD-RE Disc

4.5.6 Sectors and Clusters

The logical block size of BD is 2048 bytes collected into recordable units called Clusters. A Cluster contains 32 logical sectors.

- The user data within a BD sector is protected by the error correction coding in the Cluster that contains the sector.
- BD discs may be recorded over one or two layers. In the case of two layers, the user area of each media appears to the Host as a single continuous address space.

The access model for BD is based upon the random access device model:

- The user data space is organized in fixed size blocks (2048 bytes/block) and addressed as logical blocks. Blocks in this Logical Block Address space may be read using only the READ (10) and READ (12) commands.
- Sectors within the user data space may be written using the WRITE(10), WRITE(12), WRITE AND VERIFY(10), and WRITE AND VERIFY(12) commands. The drive may be required to perform read-modify-write sequences.
- Logical Block Addresses are numbered from 0 through CAPACITY-1. The value of CAPACITY-1 is the Logical Block Address returned by the READ CAPACITY command.
- The READ TOC/PMA/ATIP command is implemented to assure compatibility with existing applications. Only formats 0 and 1 are implemented. Some structures may be fabricated.
- Structures unique to BD may be read using the READ DISC STRUCTURE command.

4.5.7 Emergency Brake

As a protection measure against Drive or media damage by certain Drive/media combinations, a data set is defined that **may** be used by specific drive models to recognize discs that need special handling to prevent fatal functioning. This data is called Emergency Brake (EB) data.

The EB data is specified in the first PIC Cluster of each Info Fragment. It consists of an EB Header, EB data field(s) and an EB Footer. EB data fields shall only be included after mutual agreement between the disc manufacturer and the involved drive manufacturer when specific models of the drive manufacturer's products require special actions when handling such discs, e.g. to prevent damage to the disc or the drive.

The Emergency Brake **may** be defined for BD-ROM, BD-RE, and BD-R.

If the Emergency Brake data from a BD disc indicates to the Drive that this disc should not be accessed by the Drive, then the TEST UNIT READY command and appropriate media accessing commands shall be terminated with CHECK CONDITION status and sense bytes SK/ASC/ASCQ shall be set to NOT READY/UNIQUE DRIVE-MEDIA INCOMPATIBILITY (02/30/1B).

4.5.8 Physical Access Control (PAC)

4.5.8.1 Overview

Physical Access Control (PAC) Clusters are disc structures that include additional information to provide interchange information. PAC Clusters shall be recorded in the INFO1/PAC1 Area and backup copies shall be recorded in the INFO2/PAC2 Area.

A PAC may be read by using the READ DISC STRUCTURE command. If permitted, a PAC may be written by using the SEND DISC STRUCTURE command.

New PACs may be defined in the future for specific applications/functions. Drives designed before the introduction date of such new PACs shall treat such PACs as "Unknown PACs". The "Unknown PAC Rules" field (see 4.5.8.2.3), provides a method to avoid compatibility problems. There are no generalized physical access restrictions for a "Known PAC".

4.5.8.2 General PAC Format

The general PAC format is shown in Table 59.

Table 59 — General PAC Format

	Byte Offset	Field Length in Bytes	Field Name
PAC Header	0	3	PAC ID
	3	1	PAC format number
	4	4	PAC Update Count
	8	4	Unknown PAC Rules
	12	1	Unknown PAC Entire Disc Flags
	13	2	Reserved (set to zeros)
	15	1	Number of Segments
	16	8	Segment 0
	24	8	Segment 1

	264	8	Segment 31
	272	112	Reserved (set to zeros)
PAC Specific Data	384	1	Known PAC Entire Disc Flags
	385	3	Reserved
	388	...	PAC Specific Information
	63487	...	
	63488 ... 65535	2048	Reserved

4.5.8.2.1 PAC ID and Format

The PAC ID (3 bytes) identifies the specific PAC Cluster. PAC IDs 000000h and FFFFFFFh are reserved. The Format number of the PAC identifies the PAC format version.

4.5.8.2.2 PAC Update Count

The PAC Update Count shall specify the total number of update operations of the current PAC. This field shall be set to 00000000h during the initial recording of the PAC, and shall be incremented by one each time the current PAC is re-written.

4.5.8.2.3 Unknown PAC Rules

The Unknown PAC Rules shall specify the required actions when the PAC ID is not set to a known value. These bytes form a field consisting of 32 individual bits. If a drive encounters multiple unknown PACs on one disc, it shall use the OR-function of the unknown PAC rules.

Each bit is either reserved, a write Control type, or a read Control type. Each Control type is associated with a specific disc area.

If a write Control type is set to zero, writing in the associated area is permitted. If a write Control type bit is set to one, writing in the associated area is prohibited.

If a read Control type is set to zero, reading in the associated area is permitted. If a read Control type bit is set to one, reading in the associated area is prohibited.

For BD-R, see [BD-Ref2] for specific Control type bit assignments.

For BD-RE, see [BD-Ref3] for specific Control type bit assignments.

If execution of some command would result in violating any Unknown PAC rule, the command shall be terminated with CHECK CONDITION status and sense bytes SK/ASC/ASCQ shall be set to ILLEGAL REQUEST/DRIVE-MEDIA FORMAT INCOMPATIBILITY FORBIDS ACCESS (05/31/08).

4.5.8.2.4 Unknown PAC Entire Disc Flags

The Unknown PAC Entire Disc Flags byte specifies Unknown PAC Rules that cover the entire disc. Bits 1 through 7 are reserved. Bit 0 specifies re-initialization rules when the PAC is unknown. On BD-RE, if bit 0 is set to zero, reformatting is permitted if it is not blocked by any other mechanism for the entire disc. On BD-RE, if bit 0 is set to one, reformatting is prohibited. On BD-R, bit 0 shall be set to one.

4.5.8.2.5 Segments

A Segment field shall specify the start and end address of a contiguous range of Clusters, called a Segment. Segments are defined starting from Segment 0 to Segment N-1, where N is specified in the Number of Segments field ($0 \leq N \leq 32$). Segments shall not overlap and shall be sorted in ascending order according to their addresses. Segments shall only start and end at Cluster boundaries. All Segment i fields, where $i \geq N$, shall be set to zeros. The first four bytes of the Segment i field, if used, shall contain the first PSN of the first Cluster belonging to the Segment, and the last four bytes shall contain the last PSN of the last Cluster belonging to the Segment.

4.5.8.2.6 Known PAC Entire Disc Flags

The Known PAC Entire Disc Flags byte specifies rules for the entire disc in case the drive is able to interpret the PAC.

4.5.8.2.7 PAC specific Information

The PAC specific information fields contain information that is specific to the current PAC.

4.5.8.3 Primary PAC

The Primary PAC (PAC ID = 50524Dh ("PRM"), PAC Format = 00h) shall be included on each BD-ROM and BD-RE. The Primary PAC is not defined for BD-R.

4.5.8.3.1 Primary PAC on BD-ROM

PACs shall be recorded in INFO1/PAC1 and INFO2/PAC2 on each layer. The BD-ROM Primary PAC provides the status of PAC recording in each of those zones.

See [BD-Ref1] for detailed format of the Primary PAC on BD-ROM.

4.5.8.3.2 Primary PAC on BD-RE

The Primary PAC Cluster shall be included on each BD-RE disc to provide information about the date when the disc was initially recorded and to identify each recorder that has recorded individual Clusters on the disc.

Up to 252 recorders **may** be identified in the Primary PAC. After 252 unique recorder IDs have been logged, recording may continue, but no more recorders may be logged.

The READ DISC STRUCTURE command is used to read the Primary PAC. This permits the examination of the id dates of each Drive that has written the disc.

See [BD-Ref3] for detailed format of the Primary PAC on BD-RE.

4.5.8.4 Disc Write Protect PAC

4.5.8.4.1 General

The Disc Write Protect PAC (PAC ID = 445750h ("DWP"), PAC Format = 00h) is optional and **may** be used to protect a disc against unintended write actions or write actions by unauthorized persons. Although the write protection typically applies only to the recording of user data, formatting is also restricted. For the case where the disc is protected against write actions by unauthorized persons, a password **may** be included. If a valid DWP PAC Cluster exists on the disc, products that understand the PAC shall follow the rules indicated by the Write protect control bits. Creating a DWP PAC during the formatting process is vendor specific.

The READ DISC STRUCTURE command is used to read the DWP PAC. This allows the Host to examine the following:

- a. Write protect status of the disc,
- b. If write protected, the type of write protect: virtual or physical,
- c. Status of an associated write protect password.

The SEND DISC STRUCTURE command is used to write the DWP PAC. This allows the Host to perform the following functions:

- a. Write protect a write enabled disc.
- b. Write enable a write protected disc.
- c. Set, change, or remove the write protect password.

There are two fields specific to the DWP PAC: the Write Protect Control Byte and the Write Protect Password.

4.5.8.4.2 Write Protect Password

The Write protect password consists of up to 32 characters according to [ASCII]. Trailing bytes not used shall be set to 00h. The write protect password shall never be transferred to the Host.

If all bytes of the Write protect password field are set to 00h, then the Write protect password is inactive. If the Write protect password field is set to all FFh, then the entire disc is permanently write protected and further recording on the disc shall not be allowed.

A DWP PAC that has no password is not write protected.

4.5.8.4.3 Write Protect Control Byte

The Write protect control byte (Table 60) specifies allowed and required actions. The Write protect control byte is at byte offset 388 in the DWP PAC.

Table 60 — Write Protect Control Byte

7	6	5	4	3	2	1	0
Reserved					PWD	PHYS	WP

WP indicates the current status of write protection. If WP is set to 0, write protection is switched off and writing of user data is allowed without any restrictions. If WP is set to 1, write protection is switched on, and writing of user data or reformatting the disc is restricted. On BD-RE, the WP bit is physically stored in the Write Protect Control Byte. On BD-R, the WP bit is physically stored in bit 0 of byte 1 025 of the Temporary Disc Definition Structure (TDDS). In all cases, WP is presented to the Host as bit 0 of the Write Protect Control Byte.

The PHYS bit indicates the method of write protection. If PHYS is set to 0, virtual write protection is enabled (see 4.5.8.4.4). After host confirmation (including optional password), **it is then possible to write** user data without changing the write protection settings on the disc. If both PHYS and WP are set to 1, physical write protection is switched on.

The PWD bit indicates if write protection includes a password. If PWD is set to 0, there is no defined password. If PWD is set to 1, a valid password has been defined.

4.5.8.4.4 Virtual Write Enable (VWE)

The Virtual Write Enable is a bit in the header of the SEND DISC STRUCTURE command when format code = 30h. The Virtual Write Enable (VWE) bit enables or disables writing to a virtually write protect enabled disc when PHYS = 0 and WP = 1. Whenever PHYS = 1, the drive ignores the setting of VWE.

When VWE is set to 1, it indicates that the host is requesting the capability to write on a virtually write protected disc. This is a temporary write capability, a media change or drive reset will cause the system to return to a write protected state. When VWE is set to 0, it indicates that the host is rescinding any temporary write capability. Table 61 shows examples of Drive/Host actions based upon typical settings.

Table 61 — Examples of Drive/Host Interaction

Initial PAC Write Protect Control Byte	Drive Behavior on Disc Mount	Host Command Issued	Drive Behavior after Host Command
No PWD/virtual/WP off 000b	No restrictions	No PWD/virtual/WP on 001b	Disc virtually write protected. PAC updated with new write protect control byte.
No PWD/virtual/WP on 001b	No data writing or WP changes until host confirmation	VWE = 1	Data writing or WP changes temporarily allowed (no changes to PAC). Media change, drive reset, host rescind (VWE=0 sent) returns disc to write protected state
No PWD/phys/WP off 010b	No restrictions	No PWD/phys/WP on 011b	Disc physically write protected. PAC updated with new write protect control byte.
No PWD/phys/WP on 011b	No data writing until confirmation and WP changed to off. No WP changes until host confirmation	No PWD/phys/WP off 010b	Data writing and WP changes allowed. PAC updated with new write protect control byte.
PWD/virtual/WP off 100b	Data writing permitted. No WP changes until host confirms password	No PWD/virtual/WP off 000b Matching password	No restrictions. PAC updated with new write protect control byte.
		Incorrect password	Error reported to host, no change in drive behavior or PAC.
PWD/virtual/WP on 101b	No data writing or WP changes until host confirms password	VWE=1 Matching password	Data writing or WP changes temporarily allowed (no changes to PAC). Media change, drive reset, host rescind (VWE=0 sent) returns disc to write protected state
PWD/phys/WP off 110b	No WP changes until host confirms password	PWD/phys/WP on Matching password	Disc is physically write protected with an associated password. PAC updated with new write protect control byte.
PWD/phys/WP on 111b	No data writing until confirmation and WP changed to off. No WP changes until host confirms password	PWD/phys/WP off Matching password	Data writing and WP changes allowed. PAC updated with new write protect control byte.

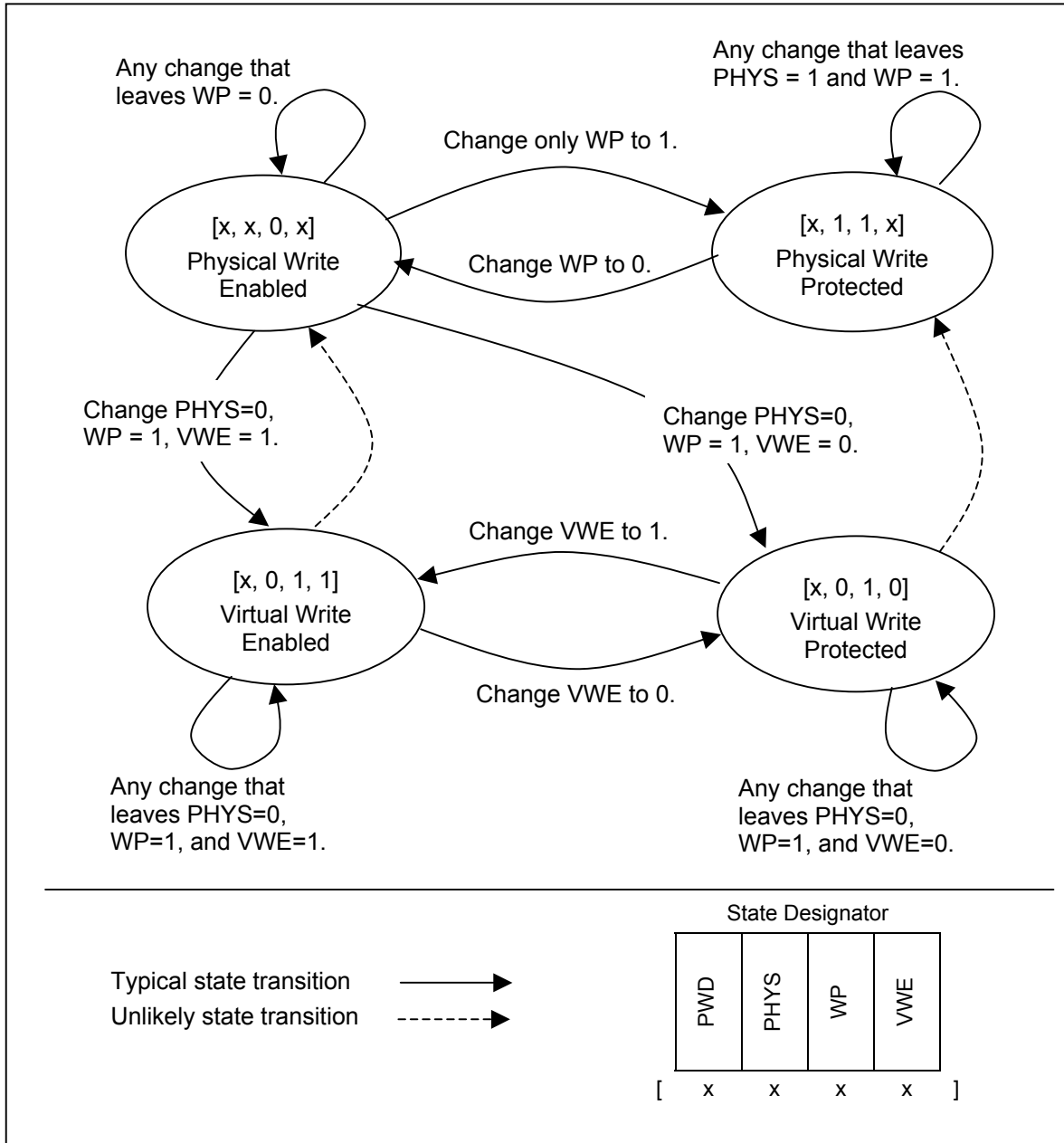

Figure 107 — Physical and Virtual Write Protect State Diagram

For all state transitions, PWD is assumed to be zero, or PWD is assumed to be one and the supplied password is correct.

4.5.8.4.5 Changing the Write Protect Password

Changing the password in the PAC requires two separate steps from the host. If the current write protection method includes a password, the host must first send the matching password to the drive, followed by a separate command with the new password.

Table 62 — Changing the Write Protect Password

Current write protection status on the disc	Host actions required to change password
Virtual write protection with existing password	<p>Step 1: Host sends DWP PAC to Drive with correct password set, and VWE=1, PWD=1, PHYS=0, WP=1.</p> <p>Step 2: Host sends DWP PAC to Drive with new password, and same WP control byte settings (PWD=1, PHYS=0, WP=1). Drive records new password onto the disc. If PWD=0, password is cleared.</p>
Virtual write protection without password	<p>Step 1: Host sends DWP PAC to Drive with VWE=1.</p> <p>Step 2: Host sends DWP PAC to Drive with password set, and WP control byte settings set to indicate password protection (PWD=1, PHYS=0, WP=1). Drive records new password and WP control byte settings onto the disc.</p>
Physical write protection with existing password	<p>Step 1: Host sends DWP PAC to Drive with correct password set, and WP control byte settings to switch off physical write protection (PWD=0, PHYS=1, WP=0). Drive records new WP control byte settings onto the disc.</p> <p>Step 2: Host sends DWP PAC to Drive with password set, and WP control byte settings set to indicate password and write protection enabled (PWD=1, PHYS=1, WP=1). Drive records new password and WP control byte settings onto the disc.</p>
Physical write protection without password	<p>Step 1: Host sends DWP PAC to Drive to switch off physical write protection (PWD=0, PHYS=1, WP=0). Drive records new WP control byte settings onto the disc.</p> <p>Step 2: Host sends DWP PAC to Drive with password set, and WP control byte settings set to indicate password and physical write protection (PWD=1, PHYS=1, WP=1). Drive records new password and WP control byte settings onto the disc.</p>
No write protection enabled, but password (PWD bit) is set.	<p>Step 1: Host sends DWP PAC to Drive with correct password set and WP control byte settings to switch off password protection (PWD=0, PHYS=same setting, WP=0). Drive records new WP control byte settings onto the disc.</p> <p>Step 2: Host sends DWP PAC to Drive with new password and WP control byte settings set to indicate password protection (PWD=1, PHYS=same setting, WP=0). Drive records new password and WP control byte settings onto the disc.</p>

4.6 The MRW Format for ReWritable Media

4.6.1 Overview

The Mount Rainier Format for ReWritable media (MRW) provides an approach to defect management on MM rewritable media that maintains read-only backward compatibility for devices that do not understand MRW while providing a measure of overwrite protection from those same devices. MRW is defined for CD-RW and DVD+RW.

A MRW format may not be defined for all media, however the specific requirements are minimal:

- The media shall consist of a continuously recordable zone that is divided into a lead-in area, followed by a user data area, followed by a lead-out area. See Figure 108.
- The medium shall be randomly rewritable.
- From the Host's perspective, the recordable block size and readable block size shall be equal and fixed at 2 048 bytes. If the low-level writable block size is greater than 2 048 bytes, then that block size shall be an integral multiple of 2 048 and an integral divisor of 65 536.
- The basic medium format shall allow blocks to be written in the lead-in without interfering with the basic medium format.
- The media shall have a firm, traditional definition for the physical location of LBA 0.

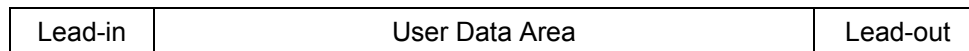

Figure 108 — General Structure of MRW Candidate Media

Each area is redefined by the MRW format as shown in Figure 109:

- A Main Table Area (MTA) is reserved from the lead-in. The MTA contains structures that identify the media format and structures for management of the defect replacement system. Parts LI1 and LI2 are not used by the MRW format and either or both may be zero in length.
- The General Application Area (GAA) provides minimally 2 Megabytes (2 097 152 bytes) of user space and shall align its logical address space exactly with the logical address space associated with the traditional media format.
- The Defect Managed Area (DMA) contains both primary user data zones and spare sector zones. The layout is media specific. The DMA is independently addressable, so it contains its own well-defined LBA 0. The actual spared block size shall be an integral multiple of 2 048, but not larger than the low-level writable block size.
- Following the DMA is the Secondary Table Area (STA). The STA is a backup copy of the MTA. The STA provides a way for a Host to access the MRW structures when connected to a device that is not MRW capable.
- The MRW format may affect the traditional start location of the disc lead-out (LO), but MRW stores no structural information in the disc LO.

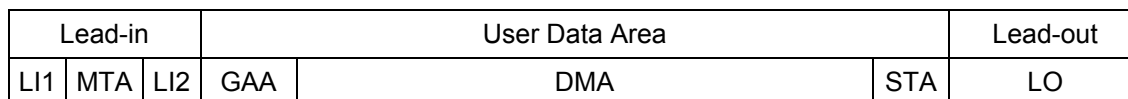

Figure 109 — Main Areas Defined by MRW

4.6.2 Consequences of a Multi-Volume Format

The Mount Rainier format is multi-volume. This simply means that a single, physical medium represents more than a single logical volume. In the case of Mount Rainier, the number of volumes is 2: the GAA and the DMA.

4.6.2.1 LBA Spaces

Two distinct LBA spaces – one for each logical volume – shall be provided. Under normal Host accesses, action on one volume is unable to modify data on the other volume. The MRW Drive provides a simple method to select between address spaces: the MRW Mode Page.

When a command references the media by LBA, the result is dependent upon the currently selected LBA Space.

4.6.2.2 Features and Events

The feature sets associated with GAA and DMA are different. In particular, the DMA has the Defect Management Feature, while the GAA does not.

When a MRW formatted (or formatting) disc is mounted, the Drive shall always default to the LBA Space of the DMA. If the Host chooses to select the GAA, then the Drive shall generate a Morph Event and change the set of features that are marked current.

4.6.3 Host Requests/Drive Responses

4.6.3.1 General

When the DMA is the current LBA Space of a MRW disc, the Removable Medium, Random Read, Random Write, Formattable, and Defect Management Features are current. Since the Core, Morphing, Timeout, and Power Management Features are common to all defined Profiles, the DMA volume has the Removable Disk Profile as current. Consequently, the Host may view the DMA volume of the MRW disc as a removable magnetic medium with a 2 048-byte sector size.

4.6.3.2 Streamed Writing

MRW permits streamed writing. This disables the defect management system during the streamed writing, thereby providing a writing method that yields fixed rate data flows principally for video applications. Streamed writing uses only the primary user space. The spare area is not used. The MRW format has no mechanism for tracking areas that are stream written versus areas that are not stream written. The Host is required to provide its own mechanism.

4.6.3.3 Formatting

In order to assure that a disc be recognized as a MRW disc, physically blank media or media with a non-MRW format shall be written. In many cases the entire surface shall be written or rewritten. This may require quite a lot of time. For this reason, MRW requires that most of the formatting occur in background. This shall be done in such a way that the media is accessible for reading and writing as soon as possible.

Background formatting has specific definitions for specific media, but the following general rules apply:

- a) Some minimal amount of formatting shall be done in foreground: initialization of the disc lead-in and GAA. Once this has been performed, the operation may go to background time.
- b) The Drive shall support a mechanism for format suspension and restart.
- c) The Drive shall always make current format status available to the Host.

Details of how background formatting operates relative to the Host are to be found in the description of the FORMAT UNIT Command.

4.7 Drive Assisted Software Defect Management

4.7.1 General

There are two types of defect management. The one is Host-based defect management (software defect management) and the other is Drive-based defect management (hardware defect management).

In the case of software defect management, a Host retrieves defect information from the Drive and performs defect management at the Host's desired timing. e.g., the software defect management is being utilized for CD-RW media. In the case of hardware defect management, the Drive itself automatically performs defect management like a DVD-RAM Drive.

Though the capacity of media is dramatically increased in comparison to CD media, the life of RW media is relatively short. The number of acceptable overwrite cycles on a sector is usually one thousand or several thousand. Therefore some sectors of the data area may be worn-out by repeated writing over the life span of the media.

This section defines the Drive assisted software defect management method for any type of rewritable media (e.g., CD-RW, DVD-RW) with Drive that supports Enhanced Defect Reporting Feature. The goal of this model is to provide a defect management mechanism to increase data reliability and media interchangeability after writing the data on a medium by the Host and the Drive. In addition, this model provides a sophisticated real-time defect management with collaboration between the Host and the Drive.

4.7.2 Basic actions for defect management

The Drive assisted software defect management consists of the following basic three actions:

1. Certification – Certify blocks on a medium
2. Detection – Detect the use of defective block
3. Management – Manage data on a defective block or manage data to be written on a defective block. Usually, data on a defective block or data to be written on a defective block is relocated to healthy block.

4.7.3 Software Defect management modes

4.7.3.1 General

The Drive assisted software defect management model defines two defect management modes. The one is Persistent defect management (Persistent-DM) mode and the other is Distributed real-time defect management (DRT-DM) mode.

4.7.3.2 Persistent defect management (Persistent-DM) mode

In the Persistent-DM mode, the "Certification" and the "Detection" actions are taken by verify after write operation of a Host. Then "Management" action is taken by the Host.

A Host should verify any written data by enabling Certification and by using one of the following commands.

- a) READ (10)
- b) READ (12) with Streaming bit = 0
- c) VERIFY (10)
- d) WRITE AND VERIFY (10)

The Drive shall perform media certification when one of the above commands is issued to the Drive. The certification result is stored in Defective Block Information (DBI) memory of the Drive. In the case of Simple DBI memory model (see 4.7.4.5.2), the DBI data is cleared and updated by the above commands. In response to READ (12) command with Streaming bit = 1, certification is vendor specific.

By using DBI memory, multiple blocks may be certified by Drive at one command.

4.7.3.3 Distributed real-time defect management (DRT-DM) mode

In addition to the functionality of the Persistent-DM mode, the DRT-DM mode provides functionality that is suitable for real-time streaming applications.

In recording real-time streaming data, recording applications usually suspend or delay the replacement of a defective block to avoid interruption of the real-time recording. In the DRT-DM mode, "Certification" action is

taken during a read operation by the Host. "Detection" action is taken during a write operation by the Host. The Host may take "Management" action after the recording operation is complete. Therefore, the DRT-DM mode is able to minimize the performance impact on the real-time operation.

The DRT-DM mode provides for certification before writing. A Drive performs media certification in response to READ (10), READ (12), or VERIFY (10) command and the Drive stores the certification result in DBI memory of the Drive. During writing of a Packet, the Drive may report a RECOVERED ERROR on WRITE (10) or WRITE (12) command by checking the DBI data that is stored during the certification. To keep compatibility with Persistent-DM mode (verify after write), the Drive shall certify the block after the writing of the block and then should check the DBI memory in response to READ (10), READ (12), VERIFY (10) or WRITE AND VERIFY (10) command.

DBI data shall be cached in DBI memory. Once a block has been certified at a certain defect level, that block shall not be assigned a lower defect level in DBI memory upon subsequent certification. This ensures that the worst case certification is made available to the Host. Regarding the defect level, see 4.7.4.3.

The Host may retrieve the stored DBI data at a later time. To keep compatibility with read-only applications that access the disc directly, the Host may suspend RECOVERED ERROR reporting on READ (10) or READ (12) command and the Host may use RECOVERED ERROR reporting on WRITE (10) or WRITE (12) command instead.

The DRT-DM mode makes use of two types of DBI memory model. One is large DBI buffer model. Another is small DBI cache memory model. See 4.7.4.5, "DBI memory management".

For the DRT-DM mode, Drive and media shall follow the Defect Level Transition model described in Section 7.6.1. When a fatal error occurs during normal overwriting, a Type 1 or Type 2 defect level shall have been detected by the Drive before the fatal error happens.

4.7.4 Enhanced Defect Reporting

4.7.4.1 General

Enhanced defect reporting provides media interchangeability by defect management and improves defect management performance by using DBI memory and provides Host/application with appropriate Drive behavior by DBI memory and various defect reporting control.

4.7.4.2 Standard playback model for DVD-RW media

To specify the interchangeable defect level between a write capable Drive and read-only Drive, a standard playback model and defect level criteria are defined.

For DVD-RW media, ordinary Consumer Electronics DVD players that support playback of DVD-RW media are defined as standard player for the standard playback model. Error correction order of the standard player is assumed as:

1. PI error correction
2. PO erasure error correction
3. EDC error detection.

No additional error correction is performed by the standard player.

Note 5. Standard playback model for other media is not defined.

4.7.4.3 Four types of defect level

The Drive assisted software defect management model defines four types of defect level to handle appropriate operation according to each type of defect. The defect level increases from Type 1 to Type 4. Type 4 is the highest severity level.

a) Type 1: Recovered light defect level

The conceptual criterion is that after 50 ~ 100 overwrite cycles, the Packet may cause uncorrectable error on standard playback model and the number of retry seek operations is small. For DVD-RW media, the recommended error threshold is that the number of PI uncorrectable line is 8 through 15. The number of seek retry times should be smaller than the number of seek retry times for Type 2 defect level. A Packet at or below this defect level should be good for data recording/playback with Consumer Electronics products.

b) Type 2: Recovered heavy defect level

The conceptual criterion is that several seek retries are required to read the Packet correctly and reading of

the Packet may become a fatal error on standard playback model. And after 50 ~ 100 overwrite cycles, reading of the Packet may become a fatal error even with the best error correction of the Drive. For DVD-RW media, the recommended error threshold is that the number of PI uncorrectable line is 16 or higher. To read a Packet correctly many seek retry operations may be required. A Packet that has this defect level may not be good for data recording/playback with Consumer Electronics products.

- c) Type 3: Unrecovered read error defect level
An unrecovered read error happens or has happened.
- d) Type 4: Write error defect level
Write error has occurred. When RECOVERED ERROR is reported by WRITE (12) command with Streaming bit = 1, some of the specified sectors are not written correctly.

4.7.4.4 Error reporting control

Reporting of a RECOVERED ERROR is controlled by the PER bit in Read/Write Error Recovery Parameters Mode Page (01h). A RECOVERED ERROR only reports the last LBA of one Packet in the REQUEST SENSE data. The Drive assisted software defect management that uses DBI memory in the Drive provides multiple Packet defect reporting capability to increase system performance.

A Drive shall report a RECOVERED ERROR when

- a) A Type 1 or Type 2 defect is detected on the medium, and
- b) Enhanced Defect Reporting Feature is current, and
- c) RECOVERED ERROR reporting is enabled.

The Enhanced defect reporting capable Drive uses only one error code for RECOVERED ERROR although there are various other ASC/ASCQs defined for RECOVERED ERRORS. When a Type 1 or Type 2 defect level is detected during media certification, the command shall be terminated with CHECK CONDITION status and sense bytes SK/ASC/ASCQ shall be set to RECOVERED ERROR/RECOVERED DATA – RECOMMEND REASSIGNMENT. When some write operations are failed during streaming write operation by WRITE (12) command with Streaming bit = 1, the Drive shall terminate the command with CHECK CONDITION status and set sense bytes SK/ASC/ASCQ to RECOVERED ERROR/RECOVERED DATA – RECOMMEND REASSIGNMENT and shall store Type 4 defect level in the DBI memory.

In the case of DRT-DM mode,

- a) If a Type 1, Type 2, or Type 3 defect is found in DBI memory upon receiving a WRITE (10), WRITE (12), or WRITE AND VERIFY (10) command and if no write error happens, the command shall be terminated with CHECK CONDITION status and sense bytes SK/ASC/ASCQ shall be set to RECOVERED ERROR/RECOVERED DATA – RECOMMEND REASSIGNMENT. The data sent by WRITE (10) or WRITE (12) command shall be written to the medium.
- b) If a Type 1, Type 2, or Type 3 defect is found in DBI memory upon receiving a WRITE (10), WRITE (12), or WRITE AND VERIFY (10) command and if write error happens, a deferred write error shall be reported. In this case RECOVERED ERROR is not returned to the Host.
- c) If a Type 1, Type 2, or Type 3 defect is found in DBI memory upon receiving a VERIFY (10) command, the command shall be terminated with CHECK CONDITION status and sense bytes SK/ASC/ASCQ shall be set to RECOVERED ERROR/RECOVERED DATA – RECOMMEND REASSIGNMENT.

Error codes to be reported and DBI update states in each case are defined in tables from Table 51 to Table 56.

Table 63 — Returned error code for commands under the Persistent-DM mode

Returned error code ¹

READ			VERIFY / WRITE AND VERIFY		
no error ²	Type 1 or 2	fatal error ³	no error	Type 1 or 2	fatal error
Good	RECOVERED ERROR/ RECOVERED DATA – RECOMMEND REASSIGNMENT	fatal	Good	RECOVERED ERROR/ RECOVERED DATA – RECOMMEND REASSIGNMENT	fatal

¹The case when RECOVERED ERROR reporting is allowed on the command. Returned error code is not affected by DBI data in DBI memory.

²This means that the defect level is lower than Type 1 defect level.

³If a fatal error happens on this command, does not include a deferred error for previous command.

Table 64 — Returned error code for READ and VERIFY commands under the DRT-DM mode

Returned error code ¹						
Defect Status in DBI memory	READ			VERIFY		
	no error ²	Type 1 or 2	fatal error ³	no error	Type 1 or 2	fatal error
no defect	Good	RECOVERED ERROR/ RECOVERED DATA – RECOMMEND REASSIGNMENT	fatal	Good	RECOVERED ERROR/ RECOVERED DATA – RECOMMEND REASSIGNMENT	fatal
Type 1 or 2	Good		fatal	Good		fatal
Type 3	Good		fatal	Good		fatal
Type 4	Good		fatal	Good		fatal

¹The case when RECOVERED ERROR reporting is allowed on the command.

²This means that the defect level is lower than Type 1 defect level.

³If a fatal error happens on this command, does not include a deferred error for previous command.

Table 65 — Returned error code for commands under the DRT-DM mode

Returned error code ¹							
Defect Status in DBI memory	WRITE			WRITE AND VERIFY			
	no error ²	fatal error ³	fatal error on Streaming bit = 1 ⁴	no error	Type 1 or 2	fatal error	
no defect	Good	fatal	RECOVERED ERROR/ RECOVERED DATA – RECOMMEND REASSIGNMENT	Good	RECOVERED ERROR/ RECOVERED DATA – RECOMMEND REASSIGNMENT	fatal	
Type 1 or 2	RECOVERED ERROR/ RECOVERED DATA – RECOMMEND REASSIGNMENT	fatal		RECOVERED ERROR/ RECOVERED DATA – RECOMMEND REASSIGNMENT		RECOVERED ERROR/ RECOVERED DATA – RECOMMEND REASSIGNMENT	fatal
Type 3		fatal					fatal
Type 4		fatal					fatal

¹The case when RECOVERED ERROR reporting is allowed on the command.

²This means that the defect level is lower than Type 1 defect level.

³If a fatal error happens on this command, does not include a deferred error for previous command.

⁴This is the case when Streaming bit is set to one, and a block is not correctly written. This block is treated as Type 4 defect.

Table 66 — Returned Deferred error code

Returned deferred error code for previous Write command		
Defect Status in DBI memory	Write command Streaming bit = 0	Write command Streaming bit = 1
no defect	fatal (not specified)	RECOVERED ERROR/RECOVERED DATA – RECOMMEND REASSIGNMENT
Type ½	fatal (not specified)	
Type 3	fatal (not specified)	
Type 4	fatal (not specified)	

Table 67 — DBI update for READ and VERIFY command¹

Update state of DBI data								
Defect Status in DBI memory	READ				VERIFY			
	no error	Type 1	Type 2	Type 3	no error	Type 1	Type 2	Type 3
no defect	no defect	Type 1	Type 2	Type 3	no defect	Type 1	Type 2	Type 3
Type 1	Type 1	Type 1	Type 2	Type 3	Type 1	Type 1	Type 2	Type 3
Type 2	Type 2	Type 2	Type 2	Type 3	Type 2	Type 2	Type 2	Type 3
Type 3	Type 3	Type 3	Type 3	Type 3	Type 3	Type 3	Type 3	Type 3
Type 4	Type 4	Type 4	Type 4	Type 4	Type 4	Type 4	Type 4	Type 4

NOTE 1: This is only applicable for small DBI cache memory model and large DBI buffer memory model.

Table 68 — DBI update for WRITE and WRITE AND VERIFY command¹

Update state of DBI data							
Defect Status in DBI memory	WRITE		WRITE AND VERIFY				
	no error	Type 4	no error	Type 1	Type 2	Type 3	Type 4
no defect	no defect	Type 4	no defect	Type 1	Type 2	Type 3	Type 4
Type 1	Type 1	Type 4	Type 1	Type 1	Type 2	Type 3	Type 4
Type 2	Type 2	Type 4	Type 2	Type 2	Type 2	Type 3	Type 4
Type 3	Type 3	Type 4	Type 3	Type 3	Type 3	Type 3	Type 4
Type 4	Type 4	Type 4	Type 4	Type 4	Type 4	Type 4	Type 4

NOTE 1: This is only applicable for small DBI cache memory model and large DBI buffer memory model

If the Drive finds defective blocks during the verify operation of VERIFY (10) or WRITE AND VERIFY (10) command, the command shall be terminated with CHECK CONDITION status when all blocks specified by the command are certified or when DBI memory overflow occurs. If DBI memory overflow occurs, the DBI Full (DBIF) bit of DBI descriptor in GET PERFORMANCE command for the Packet that caused DBI buffer full shall be set to 1.

In the case of DRT-DM mode, fatal errors are registered in the DBI memory during the certification process. When the Drive receives a WRITE command to be written to the fatal error Packet, the Drive shall terminate the WRITE command with CHECK CONDITION status and set sense bytes SK/ASC/ASCQ RECOVERED

ERROR/RECOVERED DATA – RECOMMEND REASSIGNMENT after completion of data transfer. The transferred data shall be written on the media normally.

When a command is terminated with CHECK CONDITION status and sense bytes SK/ASC/ASCQ is set to RECOVERED ERROR/RECOVERED DATA – RECOMMEND REASSIGNMENT the Host should check the DBI data.

To keep compatibility with read-only applications (e.g., DVD-Video playback software), reporting of a RECOVERED ERROR on READ (10) or READ (12) command may be suspended by the EMCDR field setting in Read/Write Error Recovery Parameters Mode Page (01h). DBI memory allows for polling of defective Packet information without using RECOVERED ERROR reporting. The EMCDR field controls media certification and error reporting on particular commands as shown in Table 58 – Definition of PER bit and EMCDR field of Persistent-DM mode and Table 59 – Definition of PER bit and EMCDR field of DRT-DM mode.

When a medium is certified, the rotation speed of the Drive may need to be adjusted to appropriate certification speed. If the certification speed is slower than the maximum reading speed of the Drive, the Host may disable media certification by setting the PER bit and the EMCDR field to 0 to use highest speed of the Drive for reading operation.

At Power-on reset and hard reset, if the Drive does not support saving of Read/Write Error Recovery Parameters Mode Page, the PER bit and the EMCDR field shall be set to zero.

The default values of the PER bit and the EMCDR field are 0.

4.7.4.5 DBI memory management

4.7.4.5.1 General

To avoid or minimize DBI data overflow with a small amount of Drive's hardware resources, there are different memory models defined to store DBI data in a Drive. They are simple DBI memory model, large DBI buffer memory model and small DBI cache memory model.

The DBI data may be cleared when the Drive is reset by Hard reset.

The DBI data shall be cleared when the medium is ejected or Drive is reset by Power on reset.

The DBI data shall not be cleared even if the PER bit and the EMCDR field are both set to zero.

4.7.4.5.2 Simple DBI memory model

The simple DBI memory model is permitted only for the Persistent-DM mode. All stored data in DBI memory is updated at the beginning of medium certification. To ensure that a simple DBI implementation gives a minimum level of usefulness and efficiency to the Host, the DBI memory shall be capable of storing at least 10 DBI entries. This allows for the DBI entries to cover a minimum of 256 + 64 KB of defective data (in the case of DVD media) before overflow occurs. This implies that if this minimum is used, the Host should not issue a READ, WRITE, or VERIFY command for more than 256 + 64 KB at a time, otherwise the command may overflow the DBI memory. The value of 10 DBI entries assumes half of Track Buffer size and information of VR playback model. The Number of entries field in Enhanced Defect Reporting Feature Descriptor indicates the number of entries that may be stored in DBI memory.

4.7.4.5.3 Large DBI buffer memory model

Some Drives (e.g., Drive that supports hardware defect management) have enough memory to cover the whole medium for defect management purpose. In this case, the Drive's memory may cover DBI data for all Packets on CD/DVD media. For the ideal case, Drive may store DBI data into a DBI bitmap that may cover entire disc. For the practical case, the Drive's memory may store 10% of the different Packet start addresses of the entire disc and length of consecutive defective Packets. Usually the spare area size is less than 5% of the entire disc capacity. To cover the spare area, 10% of the entire disc capacity should be enough size for Large DBI buffer memory model.

4.7.4.5.4 Small DBI cache memory model

4.7.4.5.4.1 General

The Drive may have small memory to store DBI data. To minimize the possibility of DBI data overflow and to allow effective Host operation, small DBI cache memory model is defined. The DBI data remains in DBI cache even if the data is read by a Host. To ensure that a small DBI implementation gives a minimum level of usefulness and efficiency to the Host, the DBI cache shall be capable of storing at least 10 DBI entries.

4.7.4.5.4.2 Three types of memory blocks in DBI memory

In the small DBI cache memory model, the DBI memory is divided into three memory blocks to minimize the possibility of DBI data overflow. Each memory block is referred to as Buffer DBI (BDBI), Read DBI (RDBI) cache, and Write DBI (WDBI) cache, respectively.

1. Buffer DBI (BDBI) block: to store certification information of sectors in data buffer
2. Read DBI (RDBI) cache memory block: to copy data from BDBI by a READ command
3. Write DBI (WDBI) cache memory block: to copy data from RDBI by a WRITE command, copy data from BDBI by a VERIFY command

The certification result of READ (10) or READ (12) command is stored in RDBI cache. The certification result of VERIFY (10) command and WRITE AND VERIFY (10) command is stored in WDBI cache. A Drive shall check RDBI cache by WRITE (10) or WRITE (12) command. If a defective Packet is found in RDBI cache, the DBI data in RDBI cache is copied to WDBI cache.

In the case of the large DBI buffer memory model, the DBI data is stored into a DBI buffer directly, then these three types of memory blocks are unified into single DBI buffer.

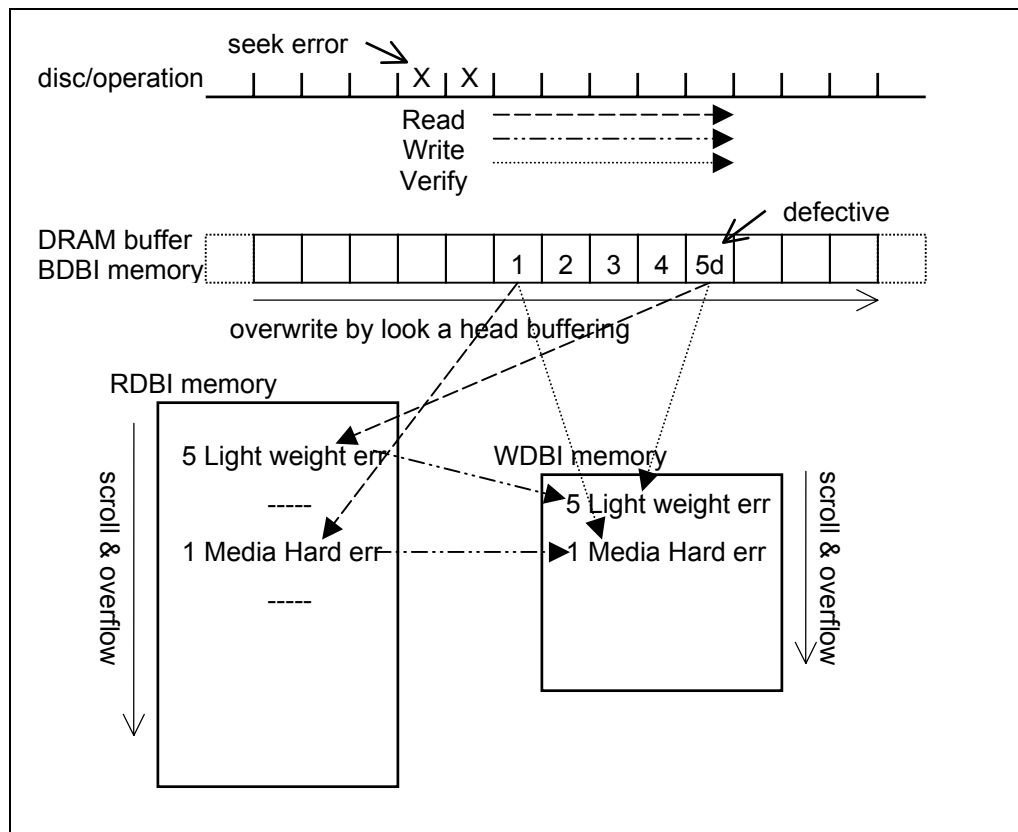

Figure 110 — Example of DBI memory blocks

4.7.4.5.4.3 Adjust DBI cache for a real-time application

The data in RDBI and WDBI cache memories may easily overflow due to accessing of multiple/large files. To protect DBI data against overflow, disc volume space may be divided into a few zones named DBI cache zone. The RDBI and WDBI caches are allocated for each DBI cache zones. e.g., in the case of UDF file system version 2.00 and DVD-VR application, at least two DBI cache zones are required to be supported. Table 69 shows an example of the DBI cache zone image.

In the case of large DBI buffer memory model, the Drive shall report the Number of DBI cache zones field value of 1 in Enhanced Defect Reporting Feature Descriptor. The Drive shall report single DBI cache zone that starts from LBA 0 to the end of the medium by GET PERFORMANCE command with Type = 05h.

Table 69 — Example of DBI cache zone image

DBI cache Zone	Major contents	Remark	Sparing
0 ¹	VRS	from 10h	not covered by sparing of UDF very important many overwritten file system data
	AVDP	100h	
	main Volume Descriptor Sequence	by AVDP	
	reserve Volume Descriptor Sequence	by AVDP	
	Logical Volume Integrity Descriptor	by VDS	
	primary Sparing Table	by VDS	
	Spare Area	by VDS	
	secondary Sparing Table	by VDS	
	Beginning of Spareable Partition	by VDS	
	Free Space Bitmap	by VDS	
	root File Entry for root directory	by VDS	
	File Entry for DVD_RTAV	by root File Entry	
	VR_MANAGR.IFO	by VR File Entry	
	1 ²	VR_MOVIE.VRO	by VR File Entry
VR_AUDIO.VRO		by VR File Entry	
VR_STILL.VRO		by VR File Entry	
¹ First DBI cache zone: from LBA 0 to before VR object files. There are very important UDF descriptors and information that are not covered by Sparing of UDF. And there are important contents that are able to be replaced to Spare Area.			
² Second DBI cache zone: from beginning of VR object files to the end of disc volume space. There are real-time contents that should not be replaced to the Spare Area.			

4.7.5 Implicit synchronize cache

When a medium certification is enabled and READ or VERIFY command is issued, and if the data to be read by the command is still remaining in the write cache of the Drive, the unwritten data shall be committed to a physical medium prior to the certification and then Drive shall read from the medium and certify the data to perform medium certification correctly.

4.7.6 Persistent-DM mode behavior

4.7.6.1 General

In the Persistent-DM mode, the Host should check the defect level of the Packets after write. The Drive stores the certification result corresponding to each READ (10)/READ (12) command with Streaming bit = 0/VERIFY (10)/ WRITE AND VERIFY (10) command in the DBI memory. One of three DBI memory models is used. As for DBI memory model, see 4.7.4.5, "DBI memory management".

The Host should enable media certification by setting of PER bit or EMCDR field.

In Persistent-DM mode, media certification by READ (12) command with Streaming bit =1 is not required. Some Drives may be unable to guarantee real-time streaming playback on 1X CLV speed in PC environment. When READ (12) command with Streaming bit =1 is issued, the rotation speed is usually higher than the speed for certification. Thus, the certification may not be able to be performed. The Type 1 defect level is detected by using READ (10), READ (12) with Streaming bit = 0, or VERIFY (10) command. The Type 1 defect level means the Packet readability is good enough for real-time playback (i.e., READ (12) with Streaming bit = 1 should not have trouble on reading the Packet).

A Host should check the defect level of the Packet using READ (12) command with Streaming bit = 0 to keep the disc compatible with standard playback model.

4.7.6.2 RECOVERED ERROR reporting control for Persistent-DM mode

When the PER bit is set to one and/or EMCDR field is set to one or higher, the Drive perform certification and report RECOVERED ERROR on READ (10)/READ (12) with Streaming bit =0, VERIFY (10), or WRITE AND VERIFY (10) command.

If PER bit is set to zero, the EMCDR field controls the RECOVERED ERROR for defect management as defined in Table 62. In this case, sense bytes SK/ASC/ASCQ shall be set to RECOVERED ERROR/RECOVERED DATA – RECOMMEND REASSIGNMENT.

If the PER bit is set to one, various kinds of RECOVERED ERROR shall be returned for any type of command. And if the EMCDR field is set to zero, the reported RECOVERED ERROR for defect management is vendor specific. If the EMCDR field is set to a value other than zero, sense bytes SK/ASC/ASCQ shall be set to RECOVERED ERROR/RECOVERED DATA – RECOMMEND REASSIGNMENT.

Table 70 — Definition of PER bit and EMCDR field of Persistent-DM mode

PER bit	EMCDR field value	Media certification ¹	RECOVERED ERROR reporting ²		
			READ ³	VERIFY	Other commands
0	0	Disabled	N/A	N/A	No
	1	Enabled	No	No	No
	2	Enabled	No	Yes	No
	3	Enabled	Yes	Yes	No
1	0	Enabled	N/A	N/A	Yes ⁴
	1	Enabled	Yes	Yes	Yes
	2	Enabled	Yes	Yes	Yes
	3	Enabled	Yes	Yes	Yes

¹On READ (10), READ (12) with Streaming = 0, VERIFY (10), or WRITE AND VERIFY (10) command.

²Except for the note 4 case, RECOVERED ERROR/RECOVERED DATA – RECOMMEND REASSIGNMENT is used for defect management purpose.

³On READ (10) or READ (12) command with Streaming=0. READ (12) with Streaming =1 is not included.

⁴Drive is allowed to use any RECOVERED ERROR code to keep legacy compatibility.

4.7.6.3 Recommend Host sequence of Persistent-DM mode

Recommend Host sequence of Persistent-DM mode

At the time of disc mounting

1. Turn on media certification (EMCDR field in Read/Write Error Recovery Parameters Mode Page)
2. Try to recognize file system of the disc
3. If the Host's File System driver does not support the file system on the disc, turn off media certification (EMCDR field in Read/Write Error Recovery Parameters Mode Page). Then pass the disc to the next possible file system driver.

At the time of disc writing

1. Write several Packets
2. Verify the written Packets
3. If a RECOVERED ERROR is reported, retrieve DBI information.

At the time of disc unmounting

1. Synchronize all cached data to the disc
2. Turn off media certification (EMCDR field in Read/Write Error Recovery Parameters Mode Page)
3. Un-mount the disc

4.7.7 DRT-DM mode behavior

4.7.7.1 General

The basic three actions of defect management are performed by different commands and timing. Certification and Detection are separated in READ command and WRITE command respectively, and are connected by DBI memory. Either small DBI cache model or large DBI buffer model shall be used.

The EMCDR field controls the reporting of RECOVERED ERRORS. The Host is able to receive RECOVERED ERROR by use of certain commands (e.g., media access command). The Host is able to retrieve DBI data at a time convenient to the Host.

1. Certification is performed at READ (10), READ (12) or VERIFY (10) command. The result is stored in DBI memory.
2. Detection is performed at WRITE (10) or WRITE (12) command with checking of DBI memory. The result is reported as RECOVERED ERROR of WRITE (10) or WRITE (12) command.
3. Management is performed by the Host. If the Host receives a RECOVERED ERROR at completion of a WRITE command, the Host should perform necessary management of written data. The Host is able to retrieve the DBI data from DBI buffer at any time.

There are two types of memory model for DBI memory. One is the large DBI buffer memory model that covers all Packets on the media. This memory model never cause DBI buffer overflow. Another is the small DBI cache memory model. This model has a special scheme to minimize cache overflow. But cache overflow is possible.

The EMCDR field controls DRT-DM behavior. When a Drive reads medium and the EMCDR field is set to a value other than 0, the Drive shall certify Packets on the medium and store the certification result into DBI memory regardless of Streaming bit setting of READ (12) command. In the case of DRT-DM mode, media certification by READ (12) command with Streaming bit = 1 shall be supported.

In the DRT-DM mode, when a write error happens at WRITE (12) command with Streaming bit = 1, the result shall be stored in DBI memory. Error reporting is dependent on the PER bit and the EMCDR field setting. If RECOVERED ERROR reporting is disabled, no RECOVERED ERROR shall be reported. In this case, the Host should check DBI data after the writing operation of WRITE (12) command with Streaming =1, if necessary.

4.7.7.2 Defect Level Transition model

In the case of real-time stream recording, the Host and Drive are not able to perform verify after write operation and defect management. Because data allocation of the real-time stream (e.g., real-time Video data) shall be determined before writing on the medium to keep data format compatibility and playback compatibility. The real-time stream data flows from Host to Drive continuously. Usually there is no time for verify after write operation and defect management. To guarantee the readability of written Packet, the Host needs to verify the Packet before write.

In the DRT-DM mode, the Drive and media shall support Defect Level Transition model. If there is neither physical impact to media (e.g., scratch, finger print) nor physical impact to Drive (e.g., shock, vibration), error level of a Packet shall not change from non-defect level to fatal defect level. Type 1 defect or Type 2 defect shall be reported before the Packet becomes unreadable by ordinary direct overwrite cycles.

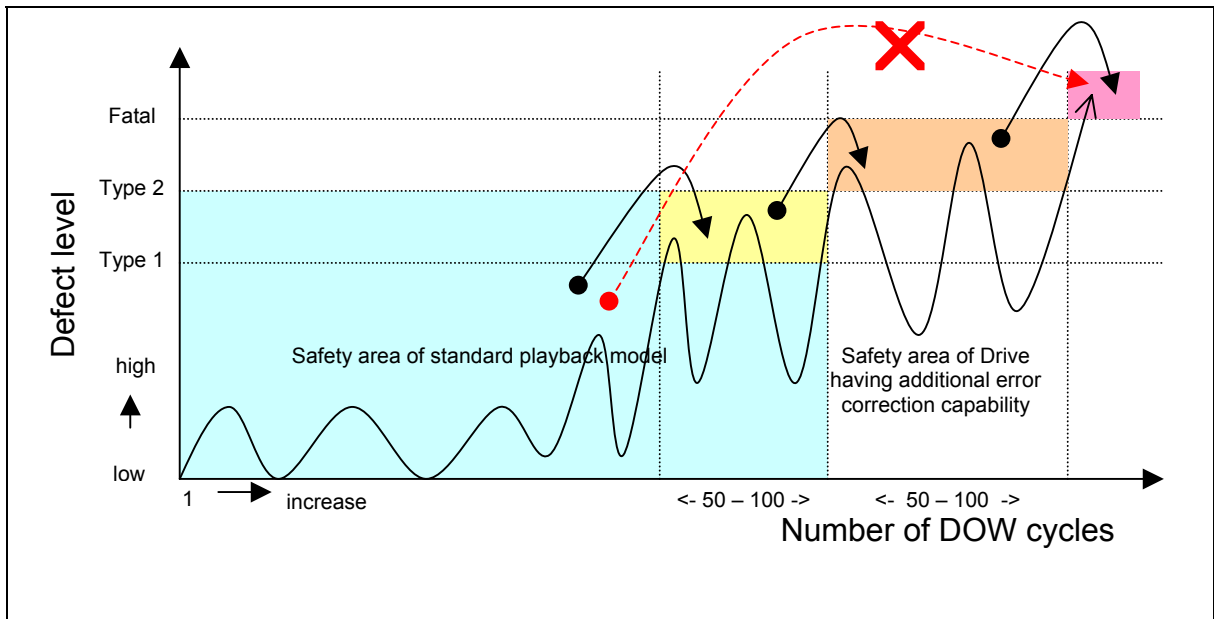

Figure 111 — Example of defect level transition

4.7.7.3 Certification

At READ command, the Drive shall certify specified blocks to be read. The result is stored in DBI memory.

In the case of small DBI cache memory model, the information of actually transferred blocks shall be stored in RDBI cache. The information of the blocks those are out of range of the command (e.g., read by look ahead buffering but not transferred to Host) shall not be stored in the RDBI cache because the blocks may already be replaced and no longer be used by the Host.

If the Drive finds defective blocks in VERIFY (10) or WRITE AND VERIFY (10) command, the command shall be terminated with CHECK CONDITION status when all blocks specified by command are certified or when DBI cache overflow occurs. The Drive shall report RECOVERED ERROR to the Host. The result is stored in DBI memory.

READ (10), READ (12), and VERIFY (10) command shall be performed normally regardless of certification. If a fatal error is detected, the Drive shall report the error normally.

4.7.7.4 Detecting the use of a defective block

Detection is performed by WRITE (10) or WRITE (12) command. The Drive shall check all written block addresses by RDBI cache or DBI buffer. When a defect information is found, the Drive shall terminate the WRITE command with CHECK CONDITION status after all data is transferred. The Drive shall report a RECOVERED ERROR to the Host. All buffered data shall be written on the media properly even if WRITE command is terminated with CHECK CONDITION status. In the case of small DBI cache memory model, when defective block is used by a WRITE command, the Drive shall store the information in WDBI cache.

If a fatal error is detected, the Drive shall report the error normally.

4.7.7.5 Management of defective block

When the Host pauses current real-time operation, the Host should perform defect management of used defective blocks, if necessary. Some of the information on defective blocks may have important data to be replaced. Some other may not be needed to replace. In the case of real-time streaming data (e.g., video stream), the data blocks are not allowed to be replaced. The Host should select suitable defect management method for such data.

If the Host receives a RECOVERED ERROR at WRITE command, some of information had been written on defective blocks. The Host should read the DBI data by GET PERFORMANCE command with Type = 04h. The Host should determine the data on defective blocks that shall be managed.

4.7.7.6 Delayed replacement of data on defective block

The RECOVERED ERROR reported by a Drive means that some of the used sectors by WRITE command are not reliable. After hundred (it may be a few hundred initially, a few times finally) overwrite cycles on the same block, the block may become unreadable. Therefore, the Host may read the written data from defective blocks, and may write them into spare area.

4.7.7.7 RECOVERED ERROR reporting control for DRT-DM mode

When the PER bit is set to one and/or the EMCDR field is set to one or higher, the Drive shall perform media certification and shall report RECOVERED ERROR on READ (10), READ (12), VERIFY (10), or WRITE AND VERIFY (10) command regardless of Streaming bit setting.

If the EMCDR field is set to zero, the Drive should not store the certification result in DBI memory to avoid overflow when the Drive supports small DBI cache memory model.

If the PER bit is set to zero, the EMCDR field controls the RECOVERED ERROR for defect management as defined in Table 59. In this case, sense bytes SK/ASC/ASCQ shall be set to RECOVERED ERROR/RECOVERED DATA – RECOMMEND REASSIGNMENT. See 4.7.4, “Enhanced defect reporting”.

When WRITE (10) or WRITE (12) command is terminated with a RECOVERED ERROR, the Drive shall write the data to the medium.

The error code of the write failure on WRITE (10), WRITE (12), or WRITE AND VERIFY (10) command is not defined in this model section. See each media model section and WRITE (10), WRITE (12), or WRITE AND VERIFY (10) command sections.

The error code of the read failure on READ (10) or READ (12) command is not defined in this model section. See each media model section and READ (10) or READ (12) command sections.

If the PER bit is set to one, various kinds of a RECOVERED ERROR shall be returned for any type of command. If the EMCDR field is set to zero, the reported RECOVERED ERROR for defect management is vendor specific. If the EMCDR field is set to a value other than zero, sense bytes SK/ASC/ASCQ shall be set to RECOVERED ERROR/RECOVERED DATA – RECOMMEND REASSIGNMENT.

Table 71 — Definition of PER bit and EMCDR field of DRT-DM mode

PER bit	EMCDR field value	Media certification ¹	RECOVERED ERROR reporting ²			
			READ ³	VERIFY	WRITE	Other commands
0	0	Disabled	N/A	N/A	N/A	No
	1	Enabled	No	No	No	No
	2	Enabled	No	Yes	Yes	No
	3	Enabled	Yes	Yes	Yes	No
1	0	Enabled	N/A	N/A	N/A	Yes ⁴
	1	Enabled	Yes	Yes	No	Yes
	2	Enabled	Yes	Yes	Yes	Yes
	3	Enabled	Yes	Yes	Yes	Yes

¹On READ (10), READ (12), VERIFY (10), or WRITE AND VERIFY (10) command.

²Except for the note 4 case, RECOVERED ERROR/RECOVERED DATA – RECOMMEND REASSIGNMENT shall be used for defect management.

³On READ (10) or READ (12) command.

⁴Drive is allowed to use any RECOVERED ERROR code to keep legacy compatibility.

4.8 Real-Time Stream Recording/Playback Model

4.8.1 General

Some applications (e.g. real-time audio and video recording/playback) require a minimally consistent data rate. Although the desired data rates are typically, significantly below the media surface rates, delays due to recovery operations and accessing fragmented data may slow the average data rate such that it falls below the application's minimum requirement. A large semiconductor buffer may provide some advantage through data rate averaging, however delays are only redistributed and a buffer of sufficient size for all cases may be impractical. The Real-time Stream Recording/Playback model defines several mechanisms that address the specific problems independently.

4.8.2 Real-Time Stream Playback

The presence of the Real-time Streaming Feature specifies that the MM reader has implemented functions that aid in real-time stream reading.

The MM reader shall implement:

- a) The GET PERFORMANCE command in order to notify the Host's application of sustainable read data rates.
- b) The SET STREAMING command in order to receive the application's data rate requirements.
- c) The SET READ-AHEAD command in order that the application may navigate the MM reader's read-ahead process.
- d) The READ (12) command in order that the application may specify that data rate is more important than data quality.

Real-time Stream Playback model addresses various causes of delay in streamed playback:

Controlling Stream Interruptions

When the media surface data rate is significantly higher than the data rate demanded by the application, the MM reader may use its read-ahead buffer as a mechanism to cover a stream interruption. If the reader has options for controlling the duration of a data stream interruption, knowledge of the required data rate may provide the application with seamless data delivery.

The application may notify the MM reader of the minimum data rate requirements by specifying them in the SET STREAMING command. The MM reader may limit certain operations (typically recovery) in order to maintain the minimum requirement.

Fragmented Storage

Even with no error recovery loss in the data, the MM device may be unable to use a read-ahead mechanism to cover data rate loss due to physical fragmentation of the logical flow due to data set navigation requirements.

The SET READ-AHEAD command provides a real-time method by which the application may schedule a redirection of the read-ahead function. This maximizes buffer utilization in data rate averaging over the loss due to seeking.

Read Retries

Many physical properties of the reader system may yield uncorrected data upon the initial read attempt, but corrected data after some number of read retries. The cost of each read retry is a full media rotation.

Each read retry is performed at a cost of one full revolution of the disc. If the application is tolerant of small error bursts, it may use the READ (12) command with the stream bit set to 1. The MM reader may return sector data that has not been completely corrected. The MM reader may still choose to perform retries if it is determined that it is possible to maintain data rate specified by the SET STREAMING command.

Accessing Defect Replacements

This is similar to the fragmented storage case. The hardware defect management system built into the media format redirects the MM reader to defect replacements. This typically causes 2 seek losses for access to only a small amount of data.

If the application is tolerant of large error bursts, it may use the READ (12) command with the stream bit set to 1. The MM reader may disable its hardware defect management system and deliver fabricated data. The MM reader may still choose to insert defect replacements into the data stream if it is determined that the

SET STREAMING specified data rate may be maintained.

Sector not found, loss of tracking errors

Some serious errors may result in several contiguous, unrecoverable sectors.

If the application is tolerant of large bursts of missing data, it may use the READ (12) command with the stream bit set to 1. The MM reader may disable its hardware defect management system (if any) and deliver fabricated data (typically all zeros). The MM reader may still choose to insert defect replacements into the data stream if it is determined that the SET STREAMING specified data rate may be maintained.

Catastrophic Delays

The application may not have specified a required minimum data rate in the SET STREAMING command. Error recoveries are not time limited. This may lead to undesired and lengthy interruptions of read data.

The MM reader may optionally implement Group 3 timeouts in order to place a time limit on error recoveries.

4.8.3 Error Handling with Hardware or No Defect Management

An erroneous block encountered on Stream playback operation should be handled according to Table 72.

Table 72 — Stream Playback Operation Error Handling

Sector Status	Command	Description
Good block	Read (10) and Read (12) with Stream=0	No Error
	Read (12) with Stream=1	No Error
Defective block registered in defect list and replaced	Read (10) and Read (12) with Stream=0	No Error
	Read (12) with Stream=1	No Error (Defect list is ignored, Null (00h) data shall be returned for Blocks listed in a defect list) ¹
Defective block registered in defect list, but not replaced or defective block with Recording Type ³ bit set to 1	Read (10) and Read (12) with Stream=0	No Error (NULL (00h) or partially corrected data may be returned) ²
	Read (12) with Stream=1	No Error (Erroneous data may be returned)
Defective block that is not registered in defect list (includes the DVD+R and DVD+RW defective block cases).	Read (10) and Read (12) with Stream=0	Report Error (Erroneous data shall not be returned when TB=0)
	Read (12) with Stream=1	No Error (Erroneous data may be returned)
¹ A legacy Drive that may not comply with this specification may return erroneous data and continue reading. ² This is defined to allow playback on a legacy system that uses the conventional READ command. ³ Recording Type is defined only for DVD-RAM and HD DVD-RAM.		

Cached data that contains an erroneous portion shall not be returned by the READ (12) command when the Streaming bit cleared. In such cases, cached data in a buffer memory is discarded and attempts to read with the conventional READ operation.

4.8.4 Real-Time Stream Recording

A hardware defect management scheme like a Linear Replacement Algorithm (Figure 112) is applied when the Drive encounters a defective sector during the conventional WRITE operation. This is done to provide a defect free LBA space.

For Stream recording applications, a hardware defect management may insert delays, potentially violating the minimal data rates required by the application.

With Real-Time Stream Recording, the Drive shall not replace a defective block even if the Drive encounters a defective block during the recording operation.

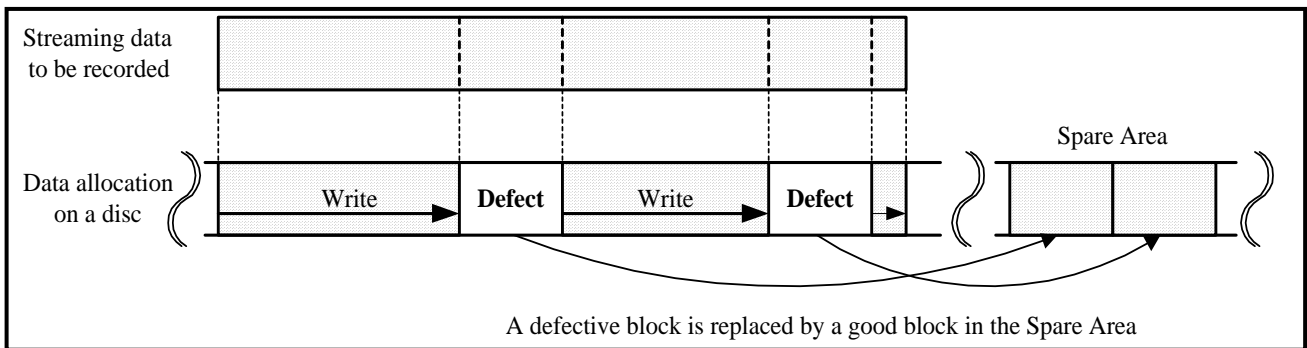

Figure 112 — Example of Data Allocation in case of Linear Replacement

The Drive that returns Real-Time Streaming Feature with Version field of 1 and SW bit of 1 shall supports the following functions.

An example of data allocation on a disc is shown in Figure 113. When the Stream recording operation is performed the Drive shall continue recording without reporting error even if a defective block is found on the Stream recording operation. The Streaming data recorded to the defective block may not be read correctly.

The Host should use WRITE (12) command with Streaming bit set to one to perform the Stream recording operation. The Drive shall not perform the Linear Replacement operation for defective block. The Drive’s performance shall be at least 1x speed even if this prevents the Drive from retry or verify operation.

The Drive shall not report CHECK CONDITION status except fatal error, even if a defective block is found on Stream recording operation. The Drive returns a fatal error when the Stream recording operation may not be continued because of critical error such as hardware error.

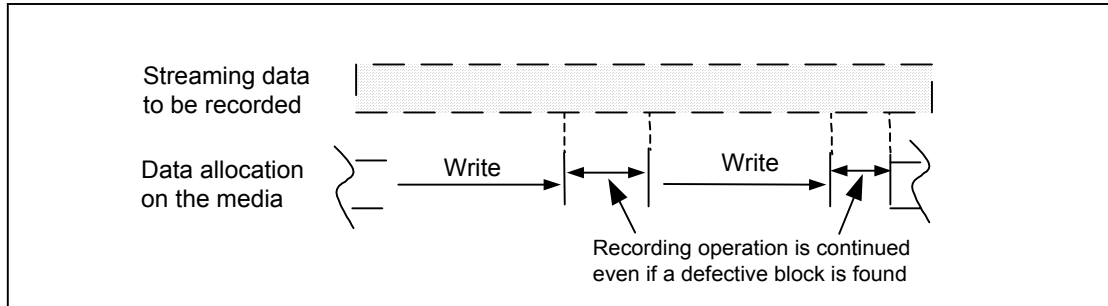

Figure 113 — An example of data allocation on the Stream recording operation

4.8.5 Error Handling with Hardware or No Defect Management

An erroneous block encountered on Stream recording operation should be handled according to Table 73. The defective block may be registered in the defect list but the linear replacement algorithm shall not be applied.

Table 73 — Error Handling on Stream Recording Operation

Sector Status	Command	Description
Good block	Write (10) and Write (12) with Stream=0	No Error
	Write (12) with Stream=1	No Error
Defective block registered in defect list and replaced	Write (10) and Write (12) with Stream=0	No Error
	Write (12) with Stream=1	Ignore defect list and keep recording (The data written on the defective block is not guaranteed)
Defective block registered in defect list, but not replaced or defective block with Recording Type ¹ bit set to 1	Write (10) and Write (12) with Stream=0	No Error (The defective block should be replaced and the data should be written to an alternative block)
	Write (12) with Stream=1	No Error (The data should be written to the defective block without error reporting, and the defective block should still be registered in defect list) ²
Defective block that is not registered in defect list (includes the DVD+R defective block and DVD+RW defective block cases).	Write (10) and Write (12) with Stream=0	No Error (The defective block should be replaced and the data should be written to an alternative block)
	Write (12) with Stream=1	No Error (The data should be written to the defective block without error reporting, and the defective block should be registered in defect list) ²
¹ Recording Type is defined only for DVD-RAM and HD DVD-RAM.		
² The defective block should be registered in defect list, but linear replacement shall not be applied.		

4.8.6 Error Handling with Software Defect Management

When Enhanced Defect Reporting Feature (0029h) is current, error reporting shall follow the setting of the PER bit and the EMCDCR field in Read/Write Error Recovery Parameters Mode Page (01h). When the Drive transfers erroneous data to the Host or when the Drive writes data to defective blocks, and if error reporting is enabled by setting of the PER bit and/or the EMCDCR field, the Drive shall complete the READ (12) command with Streaming bit set to one/WRITE (12) command with Streaming bit set to one with CHECK CONDITION status, RECOVERED DATA – RECOMMEND REASSIGNMENT at the command completion.

4.8.7 Fatal error recovery model with Group 3 time-out

Group 3 time-out and commands that are included in Group 3 time-out are used for fatal error recovery at real-time stream recording/playback.

When a fatal error has occurred during real-time stream recording/playback operation, the Host needs some recovery action to climb over or fix the fatal error. e.g., in case of playback, application user may want to see further story than the suspended scene. In case of recording, application user may want to use the disc for another recording. If the Host did not perform any recovery action, the next recording may encounter the same fatal error again.

To recover from fatal error, there are two points to be taken care.

1. Reasonable response time
2. Defend from more damage

If recovery action takes very long time, in case of playback, application user may not wait such long time. In the worst case, user may be confused as system freezes. In case of recording, Streaming data may be lost. Hence the recovery action should be limited to be terminated within a reasonable time length.

A fatal error of Real-time Stream recording/playback is usually the physical problem of the Drive (e.g., to hinder the Drive from positioning the optical pickup to the target track, focusing the laser beam to the disc surface or

finding the target sector). Unnecessary overdoing of retry action may cause more physical damage of the Drive or the medium. Then Host needs to select appropriate method and retry times. The Drive should not perform too much retry action internally.

4.9 Timely Safe Recording (TSR) method

4.9.1 General

Timely Safe Recording (TSR) defines a mechanism for defect management that permits the Host to share in the defect management with a Drive that supports the Hardware Defect Management Feature. By sharing the Host's larger buffer, computing resources, and the knowledge of the application needs, the efficiency of defect management is improved.

When a Drive performs recording with defect management, buffered data flows through the buffer attaining different status (Figure 114), based upon the recording process.



Figure 114 — Buffered Data Status

Verification is typically performed without the need to retain the data associated with the writable unit being verified. However, data awaiting verification is maintained in the Drive buffer in the event that a replacement is required. If a replacement is required, the recording process must be stopped in order to perform the replacement. This **may** lead to irregular performance.

With TSR, the Host determines the sequencing and provides the part of the buffer that represents written data waiting for verification. Since the Host is providing the sequencing of the recording process, actual defect relocations **may** be performed at any time after the original recording process has been done. So, the linear process typically performed by the Drive **may** occur in a non-linear way. The Drive is required only to log the locations of defective writable units and notify the Host within a specified time that some defects have been detected.

This method is applicable to any media type with the Hardware Defect Management Feature. The resulting media is read-write backward compatible with legacy host-Drive pairs.

The Drive reports support of this feature through TSR Feature (Feature Code 0042h).

The Host and the Drive agree on an error reporting threshold via the Error Reporting Window length field of the Read/Write Error Detection and Recovery Parameters Mode Page. The Drive signals the necessity to read defect information via sense data. The host gathers this defect information using the GET PERFORMANCE command.

For this method, the recording is organized in two phases.

1. During phase 1, defect detection is enabled, however, defect replacement is disabled.
2. During phase 2, there are 3 options for processing the data:
 - a. The Host may choose to write data associated with defective locations with the streaming bit set to zero in order to force replacement by the drive's defect management system. This is the typical action for non-streamed data.
 - b. Ignore the defects – no defect management is performed. e.g. the defects are not serious enough to affect the application needs
 - c. The Host may perform its own defect management. e.g. Using multiple extents within the file system. The method is completely determined by the Host to fit the application needs and could differ significantly from what the Drive is able to do.

4.9.2 Two phase recording

4.9.2.1 Phase one – Fast recording and error detection

During this phase, the host issues WRITE (10) or WRITE (12) commands with the TSR bit set to one. The Drive receives data from the Host and begins the recording process as soon as possible. Since the Drive is not

performing any defect replacements, it may view its buffer size to be the Host's buffer size. The Drive shall not record more than Error Report Window sectors before performing verification.

During the writing process, the Drive collects information about defective writes, but does not perform relocations, regardless of the setting of the AWRE bit in mode page 01h. The collected defect information is kept in the Drive and the Host **may** read this information by sending the GET PERFORMANCE command with Type=02h (Defect Status data). Once the data for Error Report Window sectors has been received by the Drive, the Drive should examine the status of verifications so far. If no defective sectors have been discovered, then the window range is shifted by the amount of verified sectors. If any defective sectors have been discovered, the Drive shall terminate the next WRITE, SYNC CACHE, or TEST UNIT READY command with CHECK CONDITION status and set sense bytes SK/ASC/ASCQ to NOT READY/WRITE ERROR RECOVERY NEEDED. The Host reads the defect information using GET PERFORMANCE command with Type=02h (Defect Status data), and resumes writing. The host may retain both the data and its destination LBA for use in the next phase. Once the Host has taken the Defect Data Status, the Drive shall shift window range by the not less than the amount of reported sectors.

The Host concludes phase one with a SYNCHRONIZE CACHE command. The Drive will finish any pending verification and report all found defective writable units (see 6.47.3 Command Processing). The host may have formed a list of defects pairs (data, LBA) at the end of this phase.

When TSR writing, the Host should avoid situations that lead to read-modify-write operations. Since the Host may not possess all of the data associated with a read-modify-write, relocation may be impossible.

When a TSR writing sequence is started, the Drive shall verify that the recording is possible according to the current performance parameters. If the Drive determines that TSR writing is unable to perform according to current performance parameters, the WRITE command shall be terminated with CHECK CONDITION status and sense bytes SK/ASC/ASCQ shall be set to ILLEGAL REQUEST/INSUFFICIENT TIME FOR OPERATION.

When TSR writing with the Streaming bit in the WRITE (12) command set to one, the Drive shall perform verifications only within the limits permitted by the current performance parameters (as given by the SET PERFORMANCE command).

4.9.2.2 Phase two – defect management for non-streamed data

During this phase, for all non-streamed data, the Host issues write commands with TSR bit set to zero for defective writable units reported by the Drive during phase one. The Drive **may** proceed with automatic reallocation / defect management.

4.9.3 Phase two – defect management for streamed data

For streamed data, the host **may** decide to take one of 3 different actions:

- a. Use the Drive's Hardware Defect Management. The Host writes the defective writable units to the original addresses. This stream will have all the content but may have timing problems during real-time playback.
- b. Allow the defects to remain. The streamed content **may** be played back and interruptions in the stream are possible due to the defective writable units. The the Host implementation simplified.
- c. The Host application may perform defect relocations in order to minimize the effects on the application. For rewritable media, the Host deduces from the defect list free good locations where it reallocates the data. For write-once media, the unrecorded locations (as defined by valid NWAs) are assumed good. For both rewritable and write-once media, the Host updates the file system information to reflect this reallocation. This is performed by relocating discrete data content (e.g. a video chunk) as a file extent – rather than using a remapping table to relocate individual writable units. In order to avoid hardware reallocation, the process is a reiteration of the TSR method, but only for the file extents that are associated with the defects. There is a potential recursion if new defects are found, however the recursion is ended by either completion or exhausting the free space of the media.

The action c) is recommended.

4.9.4 Implementation notes for the Drive

The Drive may simplify its implementation by using the deferred error report possibility brought by the TSR error reporting threshold only for sequential segments. First, the Drive notes the starting LBA (SLBA) of the sequential writing range. Then it would perform verification::

when the LBA of a write command minus SLBA is greater than or equal to the Error Reporting Window size, or

when a non-sequential write interrupts the sequential writing, or at a time that is vendor specific.

If the application is terminated unexpectedly before completing Phase 2, defective writable units that are found during Phase 1 may remain unreadable. If a WRITE command that writes less than a writable unit is issued to such a defective writable unit, other sectors in the writable unit may be unreadable. When the media format supports a defect list entry that labels a writable unit defective but not relocated, the Drive may re-use such defect list entries when the actual relocation is performed. This also provides a back-up defect list that **may** be used when the Host has lost its defect list due to early termination.

4.9.5 Example of TSR Recording over a Single LBA Range

Initially, the Host Buffer (32 MB) is empty, the Drive Buffer (1 MB) is empty. The maximum size of the Error Report Window is the Host buffer size. In this example, the Error Report Window size is exactly the Host buffer size. The Host has decided upon a specific LBA range to write (Figure 115).

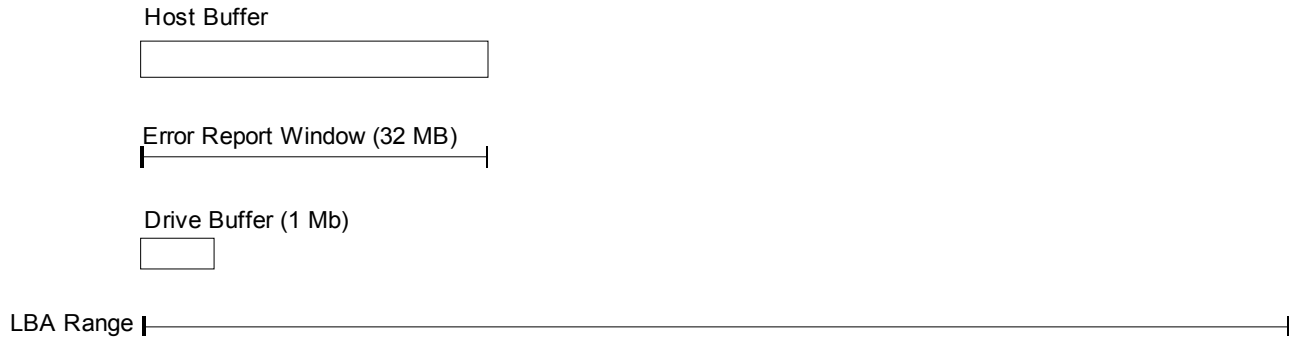

Figure 115 — Initial conditions prior to starting TSR recording

In Figure 116, when the Host's buffer shows 16 MB delivered to the Drive. The status is as follows:
 15 MB is written.
 1 MB is in the Drive Buffer, and is in the process of being written.
 It is not yet required that any of the written data be verified.

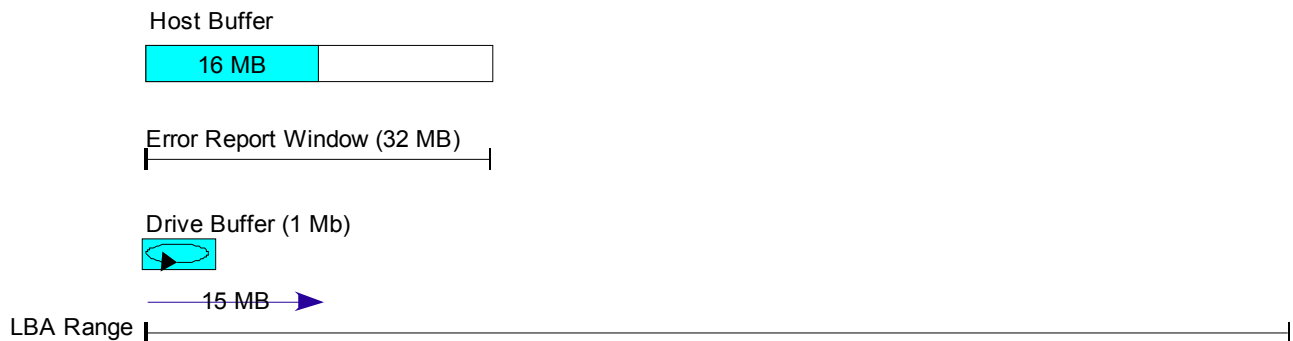

Figure 116 — Recording Begins

In Figure 117, 48 MB has been delivered through the Host buffer. The status is as follows:
 The most recently delivered 32 MB remains in the Host Buffer.
 47 MB has been written to the media.
 1 MB is in the Drive Buffer, and is in the process of being written.
 The Error Report Window has shifted by the total amount of data sent minus the 32 MB window.
 At least 15 MB has been verified – the amount no longer in the Error Report Window.
 No defective writable units have been discovered so far.

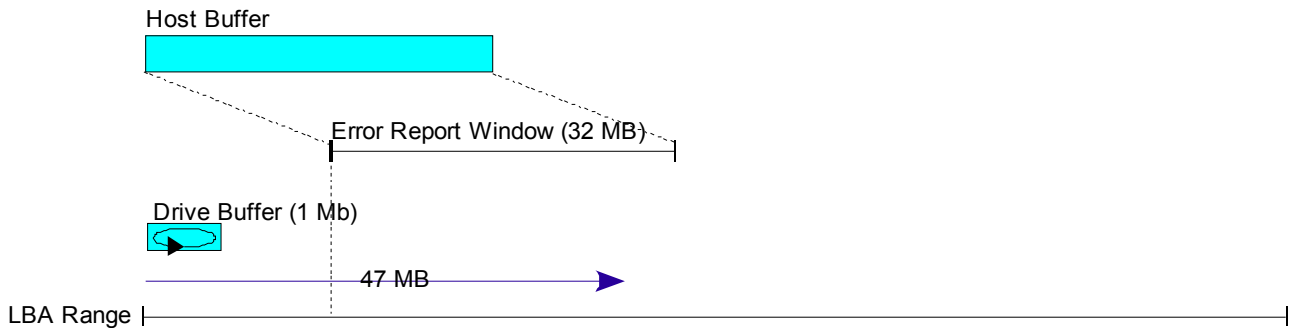

Figure 117 — Recording continues with no discovered defects

In Figure 118, 76 MB has been delivered to the Drive through the Host Buffer. The status is as follows:
 75 MB has been written to the media.
 1 MB is in the Drive Buffer, and is in the process of being written.
 Two defective writable units have been written and are in the Error Report Window.
 Verification has discovered the first defective writable unit.
 When the defective writable units were written, the defects were not discovered. The defects are not discovered until verification. Once a the verification discovers the defective writable units, the Host may be notified of the defects. In this case, the defects have not yet been reported.

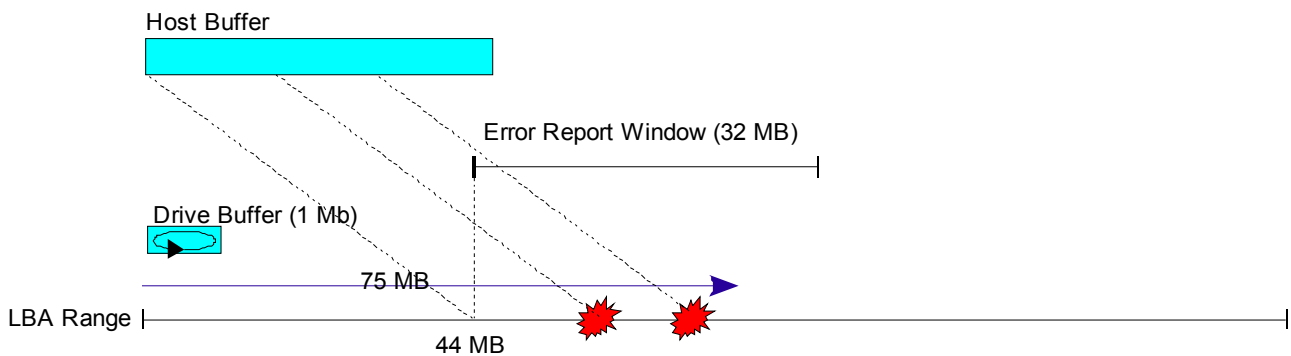

Figure 118 — Defects appear in the Error Report Window

In Figure 119, 92 MB has been delivered through the Host Buffer. The status is as follows:
 91 MB has been written to the media.
 1 MB is in the Drive Buffer, but writing is suspended.
 The verification process has discovered the second defective writable unit.
 Writing has been suspended until the Host collects the defect status by issuing the GET PERFORMANCE command.

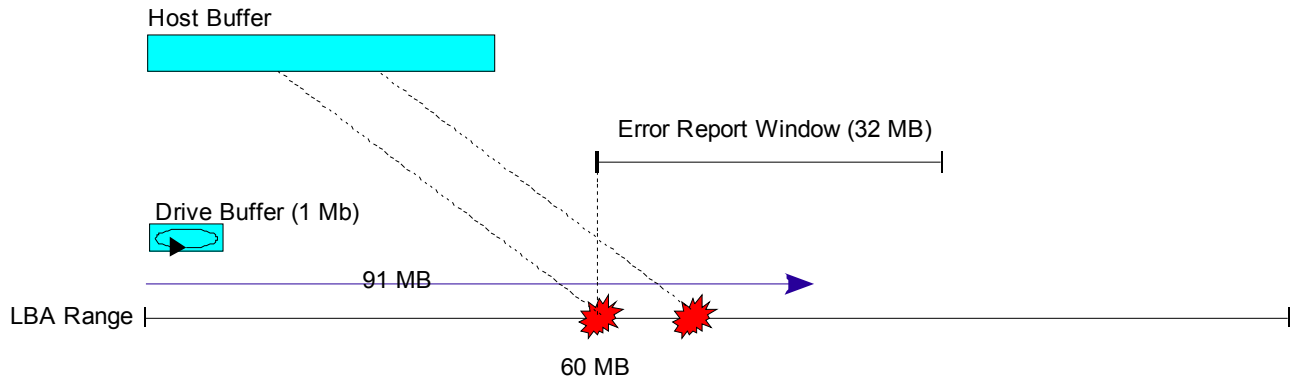

Figure 119 — Last Chance to Notify Host of Defects

After the existence of defects are reported:
 In Figure 120, the LBA range of the Error Report Window is moved forward to the first writable unit that has not been verified and writing from the Drive Buffer is restarted..

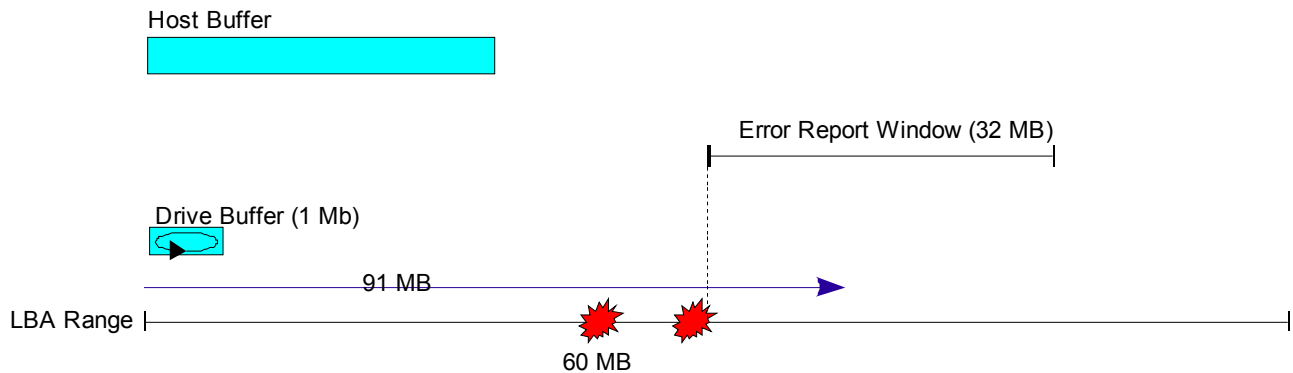

Figure 120 — Error Report Window Range is beyond known defects

The phase 1 recording process continues until the entire range of data has been written by the Host, recorded, and verified by the Drive.

4.10 Content Protection

4.10.1 Overview

4.10.1.1 General

A content protection scheme is intended to protect recorded data from being accessed by any unauthorized application. The data is typically mapped by some arithmetic encryption. A reading application finds the data unusable unless some number of decrypting secrets are known.

4.10.1.2 Block Ciphers

A block cipher is a symmetric key cipher that operates on fixed-length groups of bits – the block size - with an unvarying mapping. When encrypting, a block cipher takes a block of N bits of content, and outputs a corresponding N bit block of encrypted data. The exact mapping is controlled using a second input — the cipher key. Decryption is similar: the decryption algorithm takes an N bit block of encrypted data together with the cipher key, and yields the original N bit block of content.

To encrypt messages longer than the block size, a sequencing mechanism is used.

The Data Encryption Standard (DES) was first specified by FIPS in 1975. DES is a 64-bit block cipher with a 56-bit key.

DES was superseded by the Advanced Encryption Standard [AES] in 2001. AES has a fixed block size (128 bits) and multiple key sizes (128, 192 or 256 bits).

4.10.1.3 Stream Ciphers

A stream cipher is a symmetric key cipher in which the original content cells (bits, bytes, etc.) are encrypted one at a time. The mapping of successive bytes varies during the encryption process.

Stream ciphers represent a different approach to symmetric encryption from block ciphers. Block ciphers operate on large blocks of digits with a fixed, unvarying mapping function. This distinction is not always clear-cut: some modes of operation use a block cipher primitive in such a way that it then acts effectively as a stream cipher. Stream ciphers typically process at a higher speed than block ciphers and have lower hardware complexity. However, stream ciphers are typically susceptible to serious security problems if used incorrectly: e.g. the same starting state must never be used twice.

4.10.1.4 Authentication

In order to protect the data from unauthorized access, neither the Drive nor the Host's application has sufficient information necessary for decryption. An authentication sequence is required in order that each entity is satisfied that the other is authorized to share its key information. This sequence is sometimes referred to as a key exchange.

The following describes the minimum key exchange:

Each entity possesses certain data: Challenge values C_H and C_D and functions K_H , and K_D .

1. The Host sends its challenge value, C_H , to the Drive.
2. The Drive calculates the value of $K_D(C_H)$.
3. The Host requests the Drive's challenge value, C_D .
4. The Host calculates the value of $K_H(C_D)$.

If both entities possess the correct "secrets" (i.e. K_H , K_D and the range from which C_H and C_D are selected), then the key is $K_D(C_H) = K_H(C_D)$.

The Content Protection schemes that follow use similar methods that have additional steps and mechanisms to add a higher degree of key protection.

4.10.2 Content-Scrambling System (CSS)

4.10.2.1 General

The Content-Scrambling System (CSS) is an encryption system used to protect video content on DVD. CSS uses a proprietary 40-bit encryption stream cipher algorithm.

Title keys are used for scrambling and descrambling actual data on DVD discs called titles.

Disc keys are used for decrypting title keys on DVD discs.

Player keys are used for decrypting disc keys on DVD discs. Each DVD player manufacturer is allocated a set of keys.

4.10.2.2 Authentication

A key exchange sequence is typically processed between the Host and Drive in order to establish a secure channel over which protected content key information may be transferred. This is performed using the REPORT KEY and SEND KEY commands. Actual key information is transferred over the secure channel using the READ DISC (DVD) STRUCTURE command.

The sequence is shown in Table 74.

Table 74 — CSS Authentication Sequence

Host Action	Drive Action	Potential Error
Issue REPORT KEY command requesting AGID	Return AGID	Drive: No AGID available.
Issue SEND KEY command with Challenge to Drive	Receive Challenge and calculate reponse.	None.
Issue REPORT KEY command to receive Drive response	Return response to Host's Challenge.	Host: Drive's response may be invalid. If invalid, Host should abort Authentication.
Issue REPORT KEY command to receive Drive's Challenge	Send Challenge to Host.	None.
Issue SEND KEY command to respond to Drive's Challenge	Receive Host's response.	Drive: Response may be invalid. If Host's response is invalid, report error to Host, abort Authentication, and release AGID.
If the Authentication sequence is not in the correct step, the Drive terminates the command, and sets sense to ILLEGAL REQUEST/COMMAND SEQUENCE ERROR.		

The Host issues the READ DISC STRUCTURE command (format=02h) to receive the Disc Key encrypted by the Bus Key. At this point, the Authentication Success Flag (ASF) is set to one, indicating that reading encrypted data is permitted.

In order to be certain that the Drive will permit reading encrypted content, the Host should issue the REPORT KEY command (format=000101, Key Class=0) in order to receive ASF.

Once authentication has successfully completed, the Host issues the REPORT KEY command (Format=000100b, Key class=0) in order to receive the Title Key encrypted by the Bus Key.

4.10.3 Content Protection for Recordable Media and Pre-Recorded Media (CPRM/CPPM)

4.10.3.1 General

Content Protection for Recordable Media and Pre-Recorded Media (CPRM / CPPM) is a mechanism for controlling the copying, moving and deletion of digital media on a host device, such as a personal computer, or other digital player. CPRM/CPPM is a form of Digital rights management.

The CPRM / CPPM Specification defines a renewable cryptographic method for protecting entertainment content when recorded on physical media. The types of physical media supported include, but are not limited to, recordable DVD media and Flash memory.

4.10.3.2 Authentication

The Authentication sequence is essentially the same as for CSS.

4.10.4 Video Content Protection for DVD+R/+RW (VCPS)

4.10.4.1 General

At the basis of the VCPS copy protection features is encryption of the recorded video data. VCPS uses the AES standard cipher. Every 2 048-byte sector on a Disc that contains protected video data is encrypted using its own unique Sector Key. For convenient navigation in a Protected Video Recording, the first 128 bytes of a sector containing video header information are not encrypted.

Encryption of the video data is not sufficient to prevent copying. For this purpose, a Recorder randomly generates a 40-bit Unique ID, which uniquely identifies a Disc. The Recorder stores this Unique ID on the Disc in a location so as to minimize the risk that DVD+R/+RW recorders that do not implement VCPS overwrite the Unique ID. The function of the Unique ID is to bind the Protected Video Recording to the physical media. For that purpose, the Unique ID serves as an ingredient for the calculation of the Sector Keys. This ensures that decryption **is** performed only if the Protected Video Recording is read from the Disc used for the original recording.

4.10.4.2 Authentication

Authentication is based upon the Diffie-Hellman sequence. Neither the Host nor the Drive **may** independently possess sufficient information to decrypt protected data. Only after authentication is completed does a licensed Host possess the information necessary to calculate to base key necessary for decryption of protected recordings.

For the Host application, the authentication sequence proceeds as follows:

1. The Host should issue a REPORT KEY command requesting Device ID in order to obtain the Device ID.
2. The Host should retrieve the Authorization Key (AKx) from the AKB built into the Host. In addition, the Host should generate a random number (RA). The Host should issue a SEND KEY command, requesting Authorization Key in order to send this information to the Drive.
3. The Host should issue a REPORT KEY command, requesting Key Contribution in order to obtain the key contribution (QD) of the Drive. Prior to accepting the key contribution QD of the Drive, the Host should verify that the Drive has returned the correct random number (RA).
4. The Host should issue a SEND KEY command, requesting Key Contribution in order to send its own key contribution (QA) to the Drive. With its key contribution QA, the Host should include the random number RD it has received from the Drive.
5. The Host should issue a REPORT KEY command, requesting DKB Hash and Unique ID in order to retrieve the DKB hash value and Unique ID from the Drive. This information will be used to calculate the Unique Key KU for Protected Video Recordings on the Disc.

If any of the commands issued during authentication results in an error, the Host should retry the authentication protocol.

The Host may process the authentication protocol multiple times. The Drive will always accept a REPORT KEY Device ID. The Drive interprets this command as a start of (a new execution of) the authentication protocol, i.e. the Drive will reset its internal authentication state. If another execution of the authentication protocol was in progress, that execution will be abandoned.

4.10.5 Advanced Access Content System (AACS)

4.10.5.1 General

AACS utilizes AES block ciphers for content protection. AACS protected content is encrypted under one or more title keys. Title keys are derived from a combination of a media key and several elements, including the volume ID of the media (e.g. a physical serial number), and a cryptographic hash of the title usage rules.

The approach of AACS provides each individual player with a unique set of decryption keys that are used in a broadcast encryption scheme. This approach allows licensors to revoke individual players by invalidating the decryption keys associated with the player.

4.10.5.2 Authentication

The AACS Authentication is a state sequenced process of 7 steps. There is an initial state from which the process is required to begin. If any step fails, the authentication process is terminated and must be restarted from the initial state.

The Drive may perform up to four authentication processes concurrently in order to serve up to four Hosts/Host Applications.

1. In the initial state an authentication process may begin. The Drive shall ensure that all the processes are in this state after Power-on Reset, Hard Reset and upon disc eject. A Host starts an authentication process by requesting a process handle: the Authentication Grant ID (AGID). This is done by issuing the REPORT KEY command for the AACS Key Class requesting AGID. If an AGID is available, the Drive returns an AGID, enters authentication state 2, and terminates the command with GOOD status. If there is no available AGID, the REPORT KEY command is terminated with CHECK CONDITION status and sense bytes SK/ASC/ASCQ are set to ILLEGAL REQUEST/SYSTEM RESOURCE FAILURE.
2. Next, the host sends a Host Certificate Challenge to the Drive by issuing the SEND KEY command with AACS Key Class and requesting Host Certificate Challenge. The Drive validates the Host Certificate Challenge. If it is valid, the Drive enters authentication state 3 and the command is terminated with GOOD status. If the Host Certificate Challenge is deemed not valid, the Drive enters the Initial state and the command is terminated with CHECK CONDITION status and sense bytes SK/ASC/ASCQ are set to ILLEGAL REQUEST/COPY PROTECTION KEY EXCHANGE FAILURE - AUTHENTICATION FAILURE.
3. The host issues the REPORT KEY command for the AACS Key Class requesting a Drive Certificate Challenge. The Drive returns the Drive Certificate Challenge and enters authentication state 4. The Host validates the Drive Certificate Challenge. If it is valid, the Host also enters authentication state 4. If the Host Certificate Challenge is deemed not valid, the Host should reset the authentication.
4. The host issues the REPORT KEY command for AACS Key Class requesting Drive Key. The Drive responds by returning the key component called Drive Key and then enters state 5. The Host uses the Drive Key to calculate the Bus Key, and enters state 5.
5. The host issues the SEND KEY command for AACS Key Class requesting Host Key. The Drive accepts the key component called Host Key, uses it to calculate the Bus Key, and enters state 6.

Step 6a – When only reading

- Reading the Volume ID using the READ DISC STRUCTURE command with Format code 80h.
- Reading the Pre-recorded Media serial number (BCA) using the READ DISC STRUCTURE command with Format code 81h.
- Reading the Media ID using the READ DISC STRUCTURE command with Format code 82h.
- Reading existing value of the Binding Nonce by using the REPORT KEY command with Key Class 02h and KEY Format 100001b

Device invalidates AGID and returns to initial state after any one of 6a described commands is sent..

Step 6b – When recording binding nonce and data

Generating a value of the Binding Nonce to be recorded onto the disc by using the REPORT KEY command with Key Class 02h and KEY Format 100000b NOTE: The BN will not be written to the media.

4.11 Write Protect

4.11.1 Types of Write Protect

For MM devices, Write Protection is defined only for rewritable media. There are six write protection types:

- a) Cartridge Write Protect
The user may set or release a Write Protection Switch or tab to disable data modification on the media.
- b) Media Specific Write Inhibit
Some Drives may disable writing to certain types of DVD-RAM media when the disc is not in a cartridge.
- c) Software Write Protect until Power-down
A Host may request write inhibit by the Drive. This write protection is typically lost after a reset or power toggle.
- d) Persistent Write Protect
The Drive may establish write inhibit by writing into a non-user area of the disc.
- e) Write Inhibit DCB
The Host may select from several write protect options. Although similar to PWP, there are more write protect options.
- f) DWP PAC
A specific way to implement PWP.
- g) Host Managed Protection
This is typically File System level protection. Host Managed Protection is beyond the scope of this document.

The write protect types available from the Drive are dependent upon the media type installed. The correlation is shown in Table 75.

Table 75 — Examples of Write Protection Associated with Media Types

Media	Software Write Protect until Power-down (SWPP)	Cartridge Write Protect (CWP)	Media Specific Write Inhibit (MSWI)	Persistent Write Protect (PWP ¹)	Write Inhibit DCB (WDCB)	DWP PAC ²
CD-RW	√					
DVD-RAM	√	√	√	√		
DVD-RW	√			√		
DVD+RW	√			√	√	
HD DVD-R	√	√				
HD DVD-RAM	√	√				
BD-R	√			√		√
BD-RE	√			√		√

¹Based upon media type and format specifications, certain writing may be permitted when PWP is set to true.

²Functions beyond PWP are available. See 4.5.8.4.

4.11.2 SWPP

If the Drive supports Software Write Protect, the Write Protect Feature (0004h) shall be present and the SSWPP bit shall be set to one, however the feature need not be current.

If the SWPP bit is supported in the Timeout and Protect Page, then SWPP status may be read using the MODE SENSE (10) command and set or cleared by using the MODE SELECT (10) command.

The status of SWPP may also be read by using the READ DISC STRUCTURE command with format field = C0h.

4.11.3 CWP

If the Drive supports Cartridge Write Protect, the Write Protect Feature (0004h) need not be present.

The Write-Inhibit hole is the mechanical switch/tab on a cartridge. When this hole is closed, the Drive may write/modify information according to the other write protection conditions. When this hole on a cartridge is open, the Drive shall not write/modify/initialize any information on the disc (including user data, defect management information and Write-inhibit flag).

The Host may read the Write-inhibit hole condition as the CWP bit value using the READ DISC STRUCTURE command with Format code C0h for all Media Type codes or Format code 09h for the DVD Media Type code.

4.11.4 MSWI

A Drive with DVD-RAM write capability, may elect to disallow writing when certain DVD-RAM media types are mounted without a cartridge. This is the Media Specific Write Inhibit case.

If the Drive supports Media Specific Write Inhibit, the Write Protect Feature (0004h) need not be present.

The Host may read the MSWI status by using the READ DISC STRUCTURE command with Format code C0h for all Media Type codes or Format code 09h for the DVD Media Type code.

4.11.5 PWP

If the Drive supports Persistent Write Protect, the Write Protect Feature (0004h) shall be present. The Write Protect Feature shall be current when a media capable of accepting PWP is mounted and ready.

When the feature is present and current, the READ DISC STRUCTURE command, with format code = C0h, is used to determine the status of the write protection.

When the feature is present and current, the SEND DISC STRUCTURE command, with format code = C0h, is used to change the status of the write protection except when PWP is implemented by the DWP PAC mechanism or the WDCB mechanism.

4.11.6 WDCB

In the case of DVD+RW (and DVD+MRW), write inhibit is implemented with a Write Inhibit DCB (WDCB). The WDCB provides for exactly one of 4 different write inhibits: no write inhibit, write inhibit the entire disc, write inhibit the data zone only, or write inhibit only the LBA space of defect managed area (disallows commands that direct the Drive to perform writing, but allows relocation during reading). The Host may choose to protect write access to the WDCB by use of a password.

The WDCB may be read using the READ DISC STRUCTURE command with format code = 30h. The WDCB may be written only by using the SEND DISC STRUCTURE command with format code = 30h. An existing WDCB may be deleted only by using the SEND DISC STRUCTURE command with format code = 30h. For details, see 6.23.3.2.28 and 6.33.3.2.9.

When the entire media is write protected by a WDCB, writing the WDCB via the SEND DISC STRUCTURE is the only writing permitted.

The WDCB may be password protected. If a WDCB is password protected, WDCB write protect status (or the password) may be changed only when the Host presents the correct password. If every byte of the password is ever set to FFh, the media shall become permanently write protected. This means that even formatting is not permitted.

4.11.7 DWP PAC

See 4.5.8.4.

4.11.8 Event Reporting

When Write Protection status of mounted medium and/or Drive is changed (e.g. all of Write protections are cleared or one of them is set to active), then any Feature that allows erasing/ formatting/ writing on the media is changed. In such a case an Operational Change Event shall be generated.

4.11.9 Error reporting

When a media is Write Protected, the Drive shall terminate with CHECK CONDITION status, any command that might cause erasing/formatting/writing on the media. The SENSE KEY shall be set to WRITE PROTECT, ASC shall be set to WRITE PROTECTED, and the ASCQ shall be set according to Table 76.

Table 76 — Write Protect ASCQ Reporting

Write Protect Status According to READ DISC STRUCTURE, format C0h				ASCQ
SWPP	CWP	MSWI	PWP	
1	-	-	-	DRIVE SOFTWARE WRITE PROTECTED
0	1	-	-	HARDWARE WRITE PROTECTED
0	0	1	-	NO ADDITIONAL SENSE CODE QUALIFIER
0	0	0	1	PERSISTENT WRITE PROTECTED

If a media is protected by a WDCB and the sector address is in a protected range, the ASCQ shall be set to NO ADDITIONAL SENSE CODE QUALIFIER. If the WDCB password contains FFh in each byte, the ASCQ shall be set to PERMANENT WRITE PROTECTED.

If the user data zone is protected by a DWP PAC or the user data zone is protected by the unknown PAC rules of some unknown PAC, then the command shall be terminated with CHECK CONDITION status and sense bytes SK/ASC/ASCQ shall be set to DATAPROTECT/WRITE PROTECTED/PERSISTENT WRITE PROTECTED.

If the DWP PAC password contains FFh in each byte, the ASCQ shall be set to PERMANENT WRITE PROTECTED.

4.12 Changer Model

4.12.1 General

The changer is a Feature of a MM device. A Drive with an embedded changer supports the MECHANISM STATUS command (6.11) and LOAD/UNLOAD MEDIUM command (6.10).

A changer device provides a storage area for more than one MM Disc. This storage area contains multiple areas called slots. Each slot contains exactly one disc. Once a disc has been placed into a given slot, it becomes locked in that position. This standard provides no capability to move a disc from one slot to another. Thus when a Disc has been moved from a given slot into the playing position, it may only be moved back into the slot that it came from. This shall be followed even if power is lost while a Disc is in the playing position or while it was being moved.

There are two basic types of changer mechanisms, one that has individually addressable eject and load capability and another that uses a magazine to hold the discs. In the former, individual discs may be changed, while in the latter all the stored discs shall be changed at one time.

Any time a disc or magazine is removed or installed from the changer, the device shall generate a Unit Attention Condition. After the Host detects the unit attention condition on a known changer device, the Host may issue a MECHANISM STATUS Command. This provides the Host with information on what disc is present or was changed.

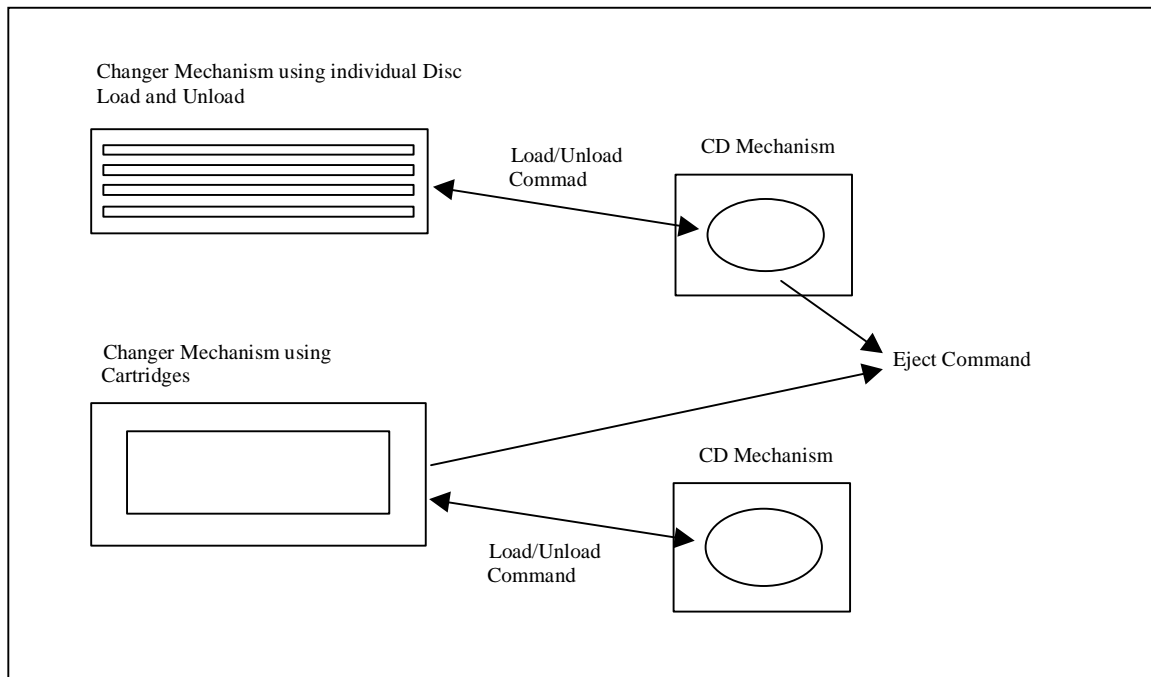

Figure 121 — Media Changer Mechanism Model

4.12.2 Side definition

4.12.2.1 Overview

As part of the DVD specifications, there is a type of media supported that includes data on more than one side of the Disc. This allows devices that are capable of automatically changing sides. For MM Devices, there is an optional capability to select each side of the Disc. Although this is not normally considered a changer type of operation, the two sides to the Disc are independent and changer like functions are a good match for selecting sides. When the Drive supports this functionality, each physical slot has two logical slots. e.g., slot 0 represents one side of the Disc, and slot 1 represents the other side.

There are two fundamental techniques used to select each side of DVD media. The first is the most space efficient. It simply moved the Pick Up (laser unit used to read the disc) to the other side. This does add

complexity to the laser mechanism to be able to position it on either the bottom or top of the media. The second approach is to flip the media over.

For a Drive that supports changing sides (see **Table 181**), the number of Slots reported shall be even, and every other slot shall be an alternating side.

4.12.2.2 Side Changing Only Drive

A Drive that is capable of changing the side of the Disc, but does not have separate Slots from the playing position, reports that it has a Mechanism type that is not a changer, but also reports Side Change Capable. This style of Drive still uses the LOAD/UNLOAD MEDIUM command to change the currently selected side. The Drive shall report two slots available.

When the Drive is able to only change sides, and not discs, it does not perform any action. This appears to the Host as a Drive with a Delayed Load type of operation.

A DVD Drive that supports changing sides is not able to report if there is actually data on both sides until each side has been read.

4.12.2.3 Attention Conditions for Sided Discs

Devices that support changing sides shall set sense bytes SK/ASC/ASCQ to UNIT ATTENTION/NOT READY TO READY CHANGE/MEDIUM MAY HAVE CHANGED for changes that involve disc loading.

4.12.2.4 Error Conditions for Sided Discs

Devices that support changing disc sides shall set sense bytes SK/ASC/ASCQ to NOT READY/NO REFERENCE POSITION FOUND to report when the currently selected side does not contain valid data.

4.12.2.5 Initialization

The Changer shall perform its initialization routine at power on or hard reset.

“Initializing Changer” is a process that refers to gathering the information that is necessary to respond to the MECHANISM STATUS command. If a changer is in the process of initializing when it receives a MECHANISM STATUS command, it responds immediately and provides no slot table information (only the Header).

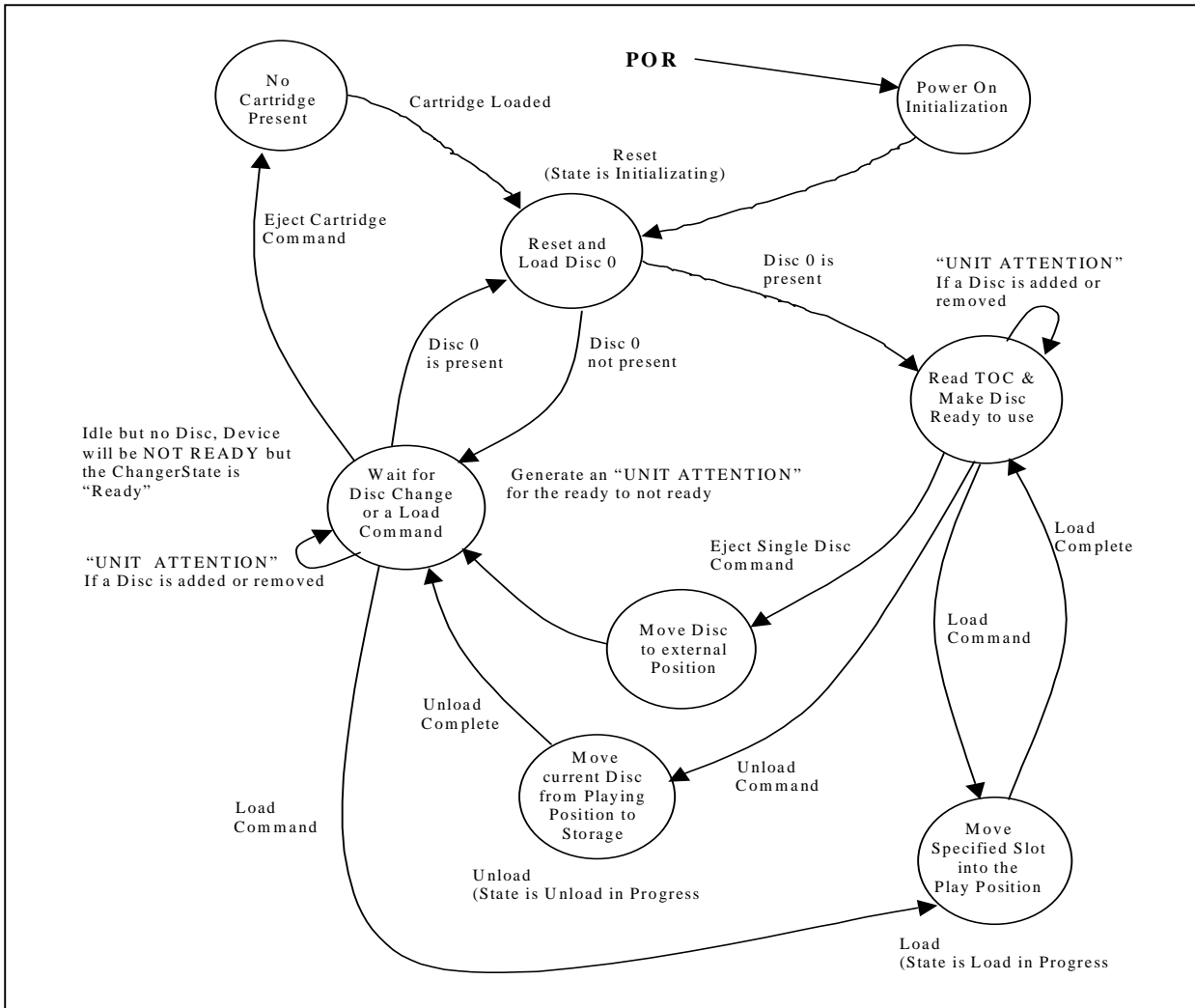

Figure 122 — Changer State Diagram

4.12.3 Changer Addressing

Several Changer specific commands use addresses called "Slots."

If any commands related to Changer operations are implemented, then all the Changer commands shall be implemented. To determine if a Drive is a changer type device, the Embedded Changer Feature shall be reported in response to an appropriate GET CONFIGURATION command.

4.12.4 Automatic Load and Unload Operations

After initialization is complete the changer shall have Disc 0 loaded into the play position. This enables drivers that are not changer aware to work with a changer device as if it were a normal single MM device. This also ensures compatibility with a Bootable MM. In support of this goal the changer shall also load and unload (Eject) default Disc 0 if the changer supports loading and unloading (Ejecting) individual Discs unless otherwise commanded by the use of one of the changer specific Load/Unload commands.

When a LOAD/UNLOAD command is received and a Disc is present in the Playing position, it shall be unloaded automatically before the specified Load operation is performed.

4.12.5 Delayed Disc load operation

MM Changer Devices may either move a disc into the playing position immediately upon receipt of a LOAD command, or delay the loading of the disc until a media access command is received. It is recommended that the device not load discs into the playing position until data from a disc that is not cached is requested from the Host.

Host drivers should expect to encounter load mechanism delays on media accesses in addition to the spin up and seek delays normally introduced with these commands.

If the device supports delayed loading and the selected disc is not in the play position, then the commands listed in Table 77 shall move the selected disc into the play position when data that has not been cached has been requested by the Host.

Table 77 — Commands that shall not cause delayed loads to occur

Commands
PLAY AUDIO (10)
PLAY AUDIO MSF
READ (10)
READ (12)
READ CD
READ CD MSF
READ CD-ROM CAPACITY
READ SUB-CHANNEL
READ TOC
SCAN

If the device supports delayed loading and the selected disc is not in the play position, then the following commands shall load the selected disc into the play position before execution of the command (See Table 78).

Table 78 — Commands that may cause delayed loads to occur

Command
SEEK
START STOP UNIT (LoEj = 1)

If the device supports delayed loading and the selected disc is not in the play position, then the following commands shall not move the selected disc into the play position. (See Table 79)

Table 79 — Commands that should not cause delayed loads to occur

Command
STOP PLAY/SCAN
START STOP UNIT (LoEj=0)
TEST UNIT READY
INQUIRY
MECHANISM STATUS
MODE SELECT
MODE SENSE
PREVENT ALLOW MEDIUM REMOVAL
REQUEST SENSE
SET CD SPEED

4.12.6 Prevent / Allow processing

There are two techniques for Prevent / Allow: either all the discs shall be prevented from being ejected by the user or each disc individually shall be prevented. If the device reports support for Software Slot Selection, then each slot shall be individually controlled by the Prevent / Allow command. Changer devices that use a Magazine and not individually controlled slots should not report the Software Slot Selection capability.

4.12.7 Error Reporting for Changers

If any of the following conditions occur during the execution of a command, the Changer shall return CHECK CONDITION status. The appropriate SK/ASC/ASCQ values shall be set. Table 80 lists some error conditions and the applicable sense keys. The list does not provide an exhaustive enumeration of all conditions that may cause the CHECK CONDITION status.

Table 80 — Error Conditions and Sense Keys for Changer Mechanisms

Condition	Sense Key
Invalid Slot Number	ILLEGAL REQUEST
Unsupported option requested	ILLEGAL REQUEST
Load or Unload to invalid slot or no Disc in source location	ILLEGAL REQUEST
Device Reset or medium change since last command	UNIT ATTENTION
Self diagnostic failed	HARDWARE ERROR

In the case of an invalid Slot number, the sense data information field shall be set to the Slot number of the first invalid address.

Attempts to eject a Disc if the changer type is magazine and there is a Disc in the playing position shall be rejected with a CHECK CONDITION status and SK/ASC/ASCQ values shall be set to ILLEGAL REQUEST/MECHANICAL POSITIONING OR CHANGER ERROR.

4.13 Hybrid Discs

4.13.1 General

A Hybrid disc is a media type consisting of at least two independent types of recording layers. This sub-clause describes the physical and logical structure of the Hybrid disc and behavior of a Drive that supports Hybrid discs.

Many kinds of optical disc physical format are defined that have the same physical sizing parameters, e.g. radius, thickness, radius of the center hole, rotational direction, and spiral direction. Consequently, it is possible to construct one disc with two or more types of recording layers, each of which conforms to an independent physical format specification.

This type of the disc is called a Hybrid disc. Each type of recording layer included in a Hybrid disc is called a Format-layer in this specification. A Format-layer consists of one or more Layers (e.g., DVD Dual Layer disc).

4.13.2 Structure of a Hybrid disc

Typically, the depth of each Format-layer and the wavelength of the corresponding laser diode in the optical pickup are different. A Format-layer conforms to its physical format specification, e.g. CD, DVD or HD DVD. Figure 123 shows an example of format-layers in a hybrid disc.

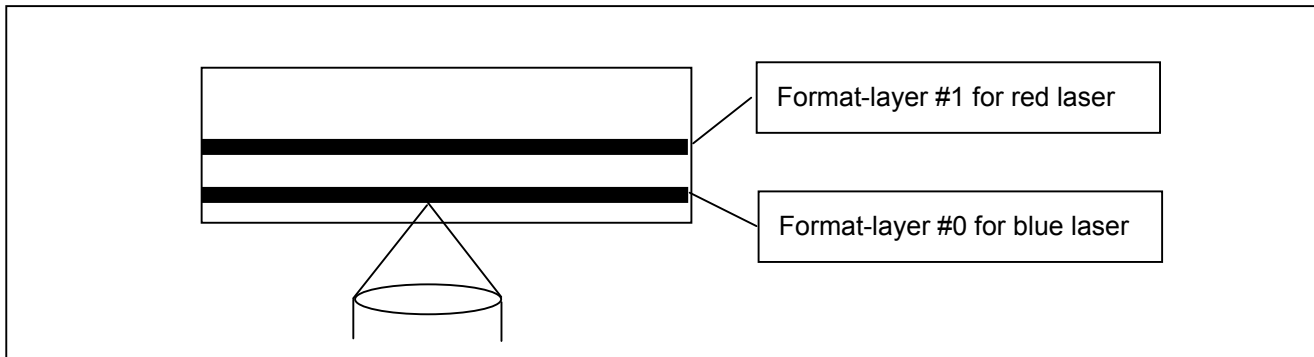

Figure 123 — Example of a Hybrid Disc

Since each Format-layer conforms to its own physical format specification, there is no change in the numbering of its physical sectors. Consequently, physical sector numbers assigned to the Format-layers may overlap partially or completely.

In order to support two or more Format-layers, the Drive has an optical pickup with the appropriate laser diodes and objective lenses for each supported Format-layer. Only one of the Format-layers may be accessed at any given time because only one of the laser diodes and its associated objective lens is able to access the inserted disc at that time. The Format-layer currently accessed by the optical pick up is called the online Format-layer. If the Drive is requested to access another Format-layer instead of the online Format-layer, it may take a very long time, e.g. 10 seconds, because power calibration and other servo and signal calibrations are necessary to access the newly selected Format-layer.

The Format-layer that becomes online when the disc is inserted is called the default Format-layer.

To access a user data recorded sector on a Format-layer specified by the Host, the Drive must assign physical sector numbers to Logical Block Addresses. The online Format-layer consists of an LBA space that starts from zero and is incremented by one toward the end of the online Format-layer. If a different Format-layer becomes the online Format-layer, the Drive assigns the LBA space to the new online Format-layer, and the previous online Format-layer cannot be accessed until it is selected as the online Format-layer again.

4.13.3 Format-layer selection mechanism using the START/STOP UNIT command

Format-layers are treated as if they are individual discs. From the Host's point of view, changing the online Format-layer appears the same as a disc exchange. Figure 124 shows the comparison of exchanging a disc and changing the online Format-layer.

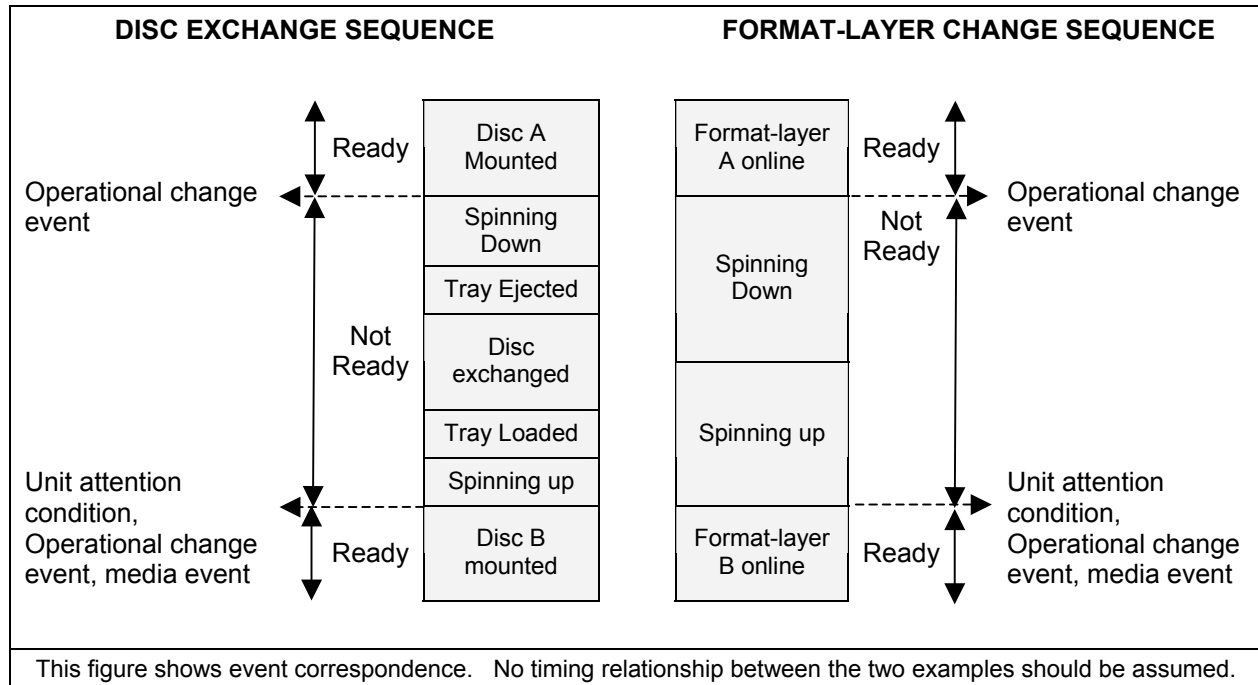

Figure 124 — Comparison of disc exchange and Format-layer change

Support for Hybrid discs in a Drive is indicated by a Hybrid disc Feature. This Feature exists when and only when the Drive supports Hybrid discs. This Feature becomes current when the Drive identifies two or more Format-layers in the mounted disc.

Format-layers are numbered from zero and incremented by one. The assignment rule of numbers to Format-layers is vendor-specific. The READ DISC STRUCTURE command with Format Code = 90h returns the relationship between the type of the identified Format-layers and their assigned numbers. The Format-layers that are not supported by the Drive are not reported in Hybrid disc structure of the READ DISC STRUCTURE command.

When the Hybrid disc Feature is current, the host is able to select the online Format-layer with the START/STOP UNIT command with FL bit set to one and the Destination Format-layer # field is set to the number of the desired Formatlayer.

If the Drive receives this command when the Hybrid disc Feature is present but not current and FL is set to one, the command shall be terminated with CHECK CONDITION status and sense bytes SK/ASC/ASCQ shall be set to ILLEGAL REQUEST/INVALID FIELD IN CDB.

The Drive treats this command as an immediate command and returns GOOD status as soon as the CDB is validated and the Drive starts changing the online Format-layer. The Drive generates a Class 1 Event and the destination Format-layer becomes online but no Profile is current. If the disc is prevented from being ejected with non-Persistent mode, the command is terminated with CHECK CONDITION status and sense bytes SK/ASC/ASCQ are set to ILLEGAL REQUEST/MEDIUM REMOVAL PREVENTED.

While the Drive is changing the online Format-layer, it is in the NOT READY state and sets the ASC/ASCQ to 04/01 LOGICAL UNIT IS IN PROCESS OF BECOMING READY.

After successfully switching to a new online Format-layer, the Drive generates the UNIT ATTENTION condition and sense bytes SK/ASC/ASCQ are set to UNIT ATTENTION/NOT READY TO READY CHANGE/FORMAT-LAYER MAY HAVE CHANGED, Class 1 Event and Class 3 Event. The Profile(s) associated with the new online Format-layer becomes current. If the Drive fails to change the online Format-layer, the Drive reports the error as a deferred error. In this case, all Profiles are still not current and the Current Profile field of GET CONFIGURATION command is set to 00h. Upon receiving a hardware reset, the default Format-layer may become online if the RI bit in the Hybrid disc Feature is zero. If the RI bit is one, the Drive preserves the online Format-layer via the hardware reset. Figure 125 shows a state diagram that illustrates Format-layer changing.

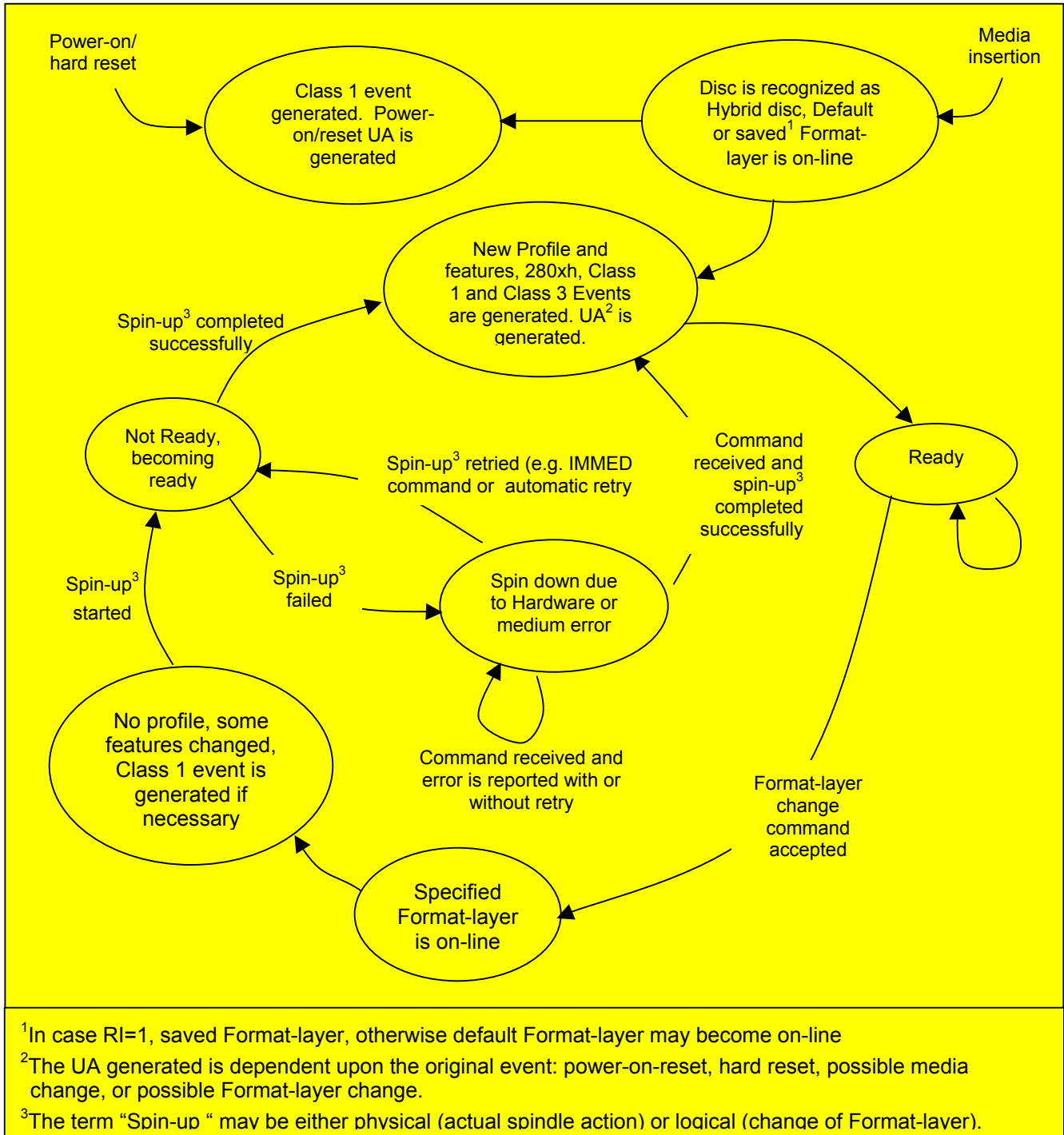

Figure 125 — State diagram of Format-layer changing

5 Features and Profiles for Multi-Media Devices

5.1 Introduction

A Multi-media Drive may appear differently to a Host depending on the type of media that is currently installed. The GET CONFIGURATION command provides a method by which the Host may discover detailed behavior information from the Drive. In response to the GET CONFIGURATION command, the Drive returns a list of descriptors that describe the situational capabilities and behaviors of the Drive. These descriptors are referred to as “Features” and “Profiles”.

A Feature is a set of commands, Mode Parameters and behaviors that specify the capabilities of a Drive and its associated medium. One or more Features may be supported by a particular Drive. In general, Features associated with device capabilities are static while Features associated with medium capabilities are dynamic. The presence of a Feature is optional, however, if a particular Feature is reported, the Drive shall implement all of the commands, mode parameters, and behaviors of that Feature.

A Profile is a base set of Features for specific Drive/media combination. A Drive may support Features in addition to those required by the Profile. A single device may implement more than one Profile, and more than one Profile may be active at any given time. Depending upon the currently mounted medium, some Features may not be active. If a device is not ready (i.e., NOT READY response to a TEST UNIT READY command), no Profile shall be current.

5.2 Feature and Profile Descriptors

5.2.1 Overview

To determine the Features supported by the Drive, the Host should issue a GET CONFIGURATION command (See 6.6). In response to the GET CONFIGURATION command the Drive shall respond with data as shown in Table 81. Response data consists of a header field and zero or more variable length Feature descriptors. The format of the Feature Header is shown in Table 82.

Table 81 — GET CONFIGURATION response data format

Bit	7	6	5	4	3	2	1	0
Byte								
0 – 7	Feature Header							
8 – n	Feature Descriptor(s)							

Table 82 — Feature Header

Bit	7	6	5	4	3	2	1	0
Byte								
0	(MSB) Data Length (LSB)							
1								
2								
3								
4	Reserved							
5	Reserved							
6	(MSB) Current Profile (LSB)							
7								

The Data Length field indicates the amount of data available given a sufficient allocation length following this field. This length shall not be truncated due to an insufficient Allocation Length. If the Data Length is greater than 65 530 bytes, multiple GET CONFIGURATION commands with different Starting Feature Numbers are

required for the Host to read all configuration data. This field is adjusted as appropriate for the given Starting Feature Number.

The Drive shall report a list of supported profiles in the Profile List Feature descriptor. The Current Profile field shall identify one of the profiles from the Profile List Feature. If there are no Profiles currently active, this field shall contain zero.

5.2.2 Feature Descriptor

A Feature Descriptor shall describe each Feature supported by a Drive. All Feature descriptors shall be a multiple of four bytes. The Feature Descriptor(s) generic format returned is defined in Table 83. Each individual Feature description is defined in the appropriate sub-clause.

Table 83 — Feature Descriptor generic format

Bit	7	6	5	4	3	2	1	0	
Byte									
0	(MSB) Feature Code								
1								(LSB)	
2	Reserved		Version				Persistent	Current	
3	Additional Length								
4 – n	Feature Dependent Data								

5.2.2.1 Feature Code

The Feature Code field shall identify a Feature supported by the Drive.

5.2.2.2 Version field

The Version field is reserved and shall be set to zero unless otherwise specified within the Feature Description. Future versions of a Feature shall be backward compatible; incompatible changes shall be included in a different Feature.

5.2.2.3 Persistent Bit

The Persistent bit, when set to zero, shall indicate that this Feature may change its current status. When set to one, shall indicate that this Feature is always active. The Drive shall not set this bit to one if the Current bit is, or may become, zero.

e.g., suppose that the feature is uniquely associated with a group of media types, each of which is removable. In that case, the Current bit shall become zero whenever the type of media mounted is not associated with the feature. For such a feature, the Persistent bit shall be set to zero.

5.2.2.4 Current Bit

The Current bit, when set to zero, indicates that this Feature is not currently active and that the Feature Dependent Data may not be valid. When set to one, this Feature is currently active and the Feature Dependent Data is valid.

e.g., suppose that the feature is uniquely associated with a group of media types, each of which is removable. In that case, the Current bit shall become zero whenever the type of media mounted is not associated with the feature.

5.2.2.5 Additional Length Field

The Additional Length field indicates the number of Feature specific bytes that follow this header. This field shall be an integral multiple of 4.

5.2.3 Defined Features

Each defined Feature is assigned a unique code or number to identify the Feature. Feature codes are shown in Table 84. The maximum number of Feature sets is 65 536 and the Feature code value of 0000h is reserved for the list of Profiles supported by the Drive.

Table 84 — Feature Codes

Feature Code	Feature Name	Description
0000h	Profile List	A list of all Profiles supported by the Drive
0001h	Core	Mandatory behavior for all devices
0002h	Morphing	The Drive is able to report operational changes to the Host and accept Host requests to prevent operational changes.
0003h	Removable Medium	The medium may be removed from the device
0004h	Write Protect	The ability to control Write Protection status
0005h – 000Fh	Reserved	—
0010h	Random Readable	The ability to read sectors with random addressing
0011h – 001Ch	Reserved	—
001Dh	Multi-Read	The Drive is able to read all CD media types; based on OSTA MultiRead
001Eh	CD Read	The ability to read CD specific structures
001Fh	DVD Read	The ability to read DVD specific structures
0020h	Random Writable	Write support for randomly addressed writes
0021h	Incremental Streaming Writable	Write support for sequential recording
0022h	Sector erasable	Write support for erasable media and media that requires an erase pass before overwrite.
0023h	Formattable	Support for formatting of media.
0024h	Hardware Defect Management	Ability of the Drive/media system to provide an apparently defect-free space.
0025h	Write Once	Write support for write-once media that is writable in random order.
0026h	Restricted Overwrite	Write support for media that shall be written from Blocking boundaries only.
0027h	CD-RW CAV Write	The ability to write high speed CD-RW media
0028h	MRW	The ability to recognize and read and optionally write MRW formatted media
0029h	Enhanced Defect Reporting	The ability to control RECOVERED ERROR reporting
002Ah	DVD+RW	The ability to recognize, read and optionally write DVD+RW media
002Bh	DVD+R	The ability to read DVD+R recorded media formats
002Ch	Rigid Restricted Overwrite	Write support for media that is required to be written from Blocking boundaries with length of integral multiple of Blocking size only.
002Dh	CD Track at Once	Ability to write CD with Track at Once recording
002Eh	CD Mastering	The ability to write CD with Session at Once or Raw write methods.

Table 84 – Feature Codes (Continued)

Feature Code	Feature Name	Description
002Fh	DVD-R/-RW Write	The ability to write DVD specific structures
0030h – 0032h	Legacy	—
0033h	Layer Jump Recording	The ability to record in layer jump mode
0034h – 0036h	Reserved	—
0037h	CD-RW Media Write Support	The ability to report CD –RW media sub-types that are supported for write
0038h	BD-R POW	Logical Block overwrite service on BD-R discs formatted as SRM+POW.
0039h – 0039h	Reserved	—
3Ah	DVD+RW Dual Layer	The ability to read DVD+RW Dual Layer recorded media formats
3Bh	DVD+R Double Layer	The ability to read DVD+R Double Layer recorded media formats
003Ch – 003Fh	Reserved	—
0040h	BD Read Feature	The ability to read control structures and user data from a BD disc
0041h	BD Write Feature	The ability to write control structures and user data to certain BD discs
0042h	TSR	Timely, Safe Recording permits the Host to schedule defect management..
0043h – 004Fh	Reserved	—
0050h	HD DVD Read	The ability to read control structures and user data from a HD DVD disc
0051h	HD DVD Write	The ability to write control structures and user data to certain HD DVD discs
0052h – 00FFh	Reserved	—
0100h	Power Management	Host and device directed power management
0101h	SMART	Ability to perform Self Monitoring Analysis and Reporting Technology
0102h	Embedded Changer	Single mechanism multiple disc changer
0103h	Legacy	—
0104h	Microcode Upgrade	Ability for the device to accept new microcode via the interface
0105h	Timeout	Ability to respond to all commands within a specific time
0106h	DVD-CSS	Ability to perform DVD CSS/CPM authentication and RPC
0107h	Real Time Streaming	Ability to read and write using Host requested performance parameters
0108h	Drive serial number	The Drive has a unique identifier.
0109h	Media Serial Number	Ability to return unique Media Serial Number
010Ah	Disc Control Blocks	The ability to read and/or write Disc Control Blocks
010Bh	DVD CPRM	The Drive supports DVD CPRM authentication
010Ch	Firmware Information	Firmware creation date report
010Dh	AACS	The ability to decode and optionally encode AACS protected information
010Eh – 010Fh	Reserved	—
0110h	VCPS	The ability to decode and optionally encode VCPS protected information
0111h – FFFFh	Reserved	—
FF00h – FFFFh	Vendor Specific	—

5.3 Feature Definitions

5.3.1 Profile List Feature (0000h)

This Feature identifies Profiles supported by the Drive. The Profile List descriptor returned is defined in Table 85. Profiles are defined as collections of Features and provide a method to quickly determine the Drive's type. This Feature is always current, even if none of the Profiles listed are current.

Table 85 — Profile List Descriptor Format

Bit Byte	7	6	5	4	3	2	1	0
0	(MSB) Feature Code = 0000h (LSB)							
1								
2	Reserved		Version			Persistent	Current	
3	Additional Length							
4 – n	Profile Descriptor(s)							

The Feature Code field shall be set to 0000h.

The Version field is reserved and shall be set to zero. Future versions of a Feature shall be backward compatible; incompatible changes shall be included in a different Feature.

The Persistent bit shall be set to one to indicate that the reporting of the Profile list is always supported.

The Current bit shall be set to one.

The Additional Length field shall be set to ((number of Profile Descriptors) * 4).

The Profile Descriptors are shown in Table 86. All Profiles supported by the Drive shall always be reported. Profile descriptors are returned in the order of preferred operation – most desirable to least desirable. e.g., a DVD-ROM that is also able to read a CD-ROM should list the DVD-ROM Profile first and the CD-ROM Profile second.

Table 86 — Profile Descriptor

Bit Byte	7	6	5	4	3	2	1	0
0	(MSB) Profile Number (LSB)							
1								
2	Reserved						CurrentP	
3	Reserved							

The Profile Number identifies a Profile to which the Drive conforms (Table 87).

The CurrentP bit, when set to one, shall indicate that this Profile is currently active. If no medium is present, no Profile should be active. Multifunction devices shall select the most appropriate Profile(s), if any, to set as current. The most appropriate current Profile is also reported in the Feature Header (See Table 82).

Table 87 — Profile List

Profile Number	Profile Name	Description
0000h	Reserved	—
0001h	Non-removable disk	Re-writable disk, capable of changing behavior
0002h	Removable disk	Re-writable; with removable media
0003h	MO Erasable	Magneto-Optical disk with sector erase capability
0004h	Optical Write Once	Optical write once
0005h	AS-MO	Advance Storage – Magneto-Optical
0006h – 0007h	Reserved	—
0008h	CD-ROM	Read only Compact Disc capable
0009h	CD-R	Write once Compact Disc capable
000Ah	CD-RW	Re-writable Compact Disc capable
000Bh – 000Fh	Reserved	—
0010h	DVD-ROM	Read only DVD
0011h	DVD-R Sequential Recording	Write once DVD using Sequential recording
0012h	DVD-RAM	Re-writable DVD
0013h	DVD-RW Restricted Overwrite	Re-recordable DVD using Restricted Overwrite
0014h	DVD-RW Sequential recording	Re-recordable DVD using Sequential recording
0015h	DVD-R Dual Layer Sequential Recording	Dual Layer DVD-R using Sequential recording
0016h	DVD-R Dual Layer Jump Recording	Dual Layer DVD-R using Layer Jump recording
0017h – 0019h	Reserved	—
001Ah	DVD+RW	DVD+ReWritable
001Bh	DVD+R	DVD+Recordable
001Ch – 0029h	Reserved	—
002Ah	DVD+RW Dual Layer	DVD+Rewritable Dual Layer
002Bh	DVD+R Double Layer	DVD+Recordable Double Layer
002Ch-003Fh	Reserved	—
0040h	BD-ROM	Blu-ray Disc ROM
0041h	BD-R SRM	Blu-ray Disc Recordable – Sequential Recording Mode
0042h	BD-R RRM	Blu-ray Disc Recordable – Random Recording Mode
0043h	BD-RE	Blu-ray Disc Rewritable
0044h – 004Fh	Reserved	—
0050h	HD DVD-ROM	Read-only HD DVD
0051h	HD DVD-R	Write-once HD DVD
0052h	HD DVD-Rewritable	Rewritable HD DVD
0053h - FFFEh	Reserved	—
FFFFh	Drives Not Conforming to a Standard Profile	The Drive does not conform to any Profile.

5.3.2 Core Feature (0001h)

This Feature identifies a Drive that supports functionality common to all devices. The Feature descriptor response data to be returned to the Host is defined in Table 88.

Table 88 — Core Feature Descriptor Format

Bit Byte	7	6	5	4	3	2	1	0
0	(MSB) Feature Code = 0001h (LSB)							
1								
2	Reserved		Version = 0010b			Persistent	Current	
3	Additional Length = 8							
4	(MSB) Physical Interface Standard (LSB)							
5								
6								
7								
8	Reserved					INQ2	DBE = 1	
9	Reserved							
10	Reserved							
11	Reserved							

The Feature Code field shall be set to 0001h.

The Version Field shall be set to 0010b.

The Persistent bit shall be set to one.

The Current bit shall be set to one.

The Additional Length field shall be set to 8.

The INQ2 bit permits the Drive to indicate support for certain features of the INQUIRY command. If INQ2 is set to one, the Drive shall support validation of EVPD, Page Code, and the 16-bit Allocation Length fields as described in [SPC-3].

DBE (Device Busy Event) shall be set to one. DBE set to zero is legacy (see 6.7.2.8).

The Physical Interface Standard field shall be set to a value selected from Table 89.

Table 89 — Physical Interface Standard

Physical Interface Standard	Description	Physical Interface Standard	Description
00000000h	Unspecified	00000008h	USB (both 1.1 and 2.0)
00000001h	SCSI Family	00000009h – 000FFFEh	Reserved
00000002h	ATAPI	000FFFFh	Vendor Unique
00000003h	IEEE 1394 – 1995	00010000h – 0001FFFFh	Defined by INCITS
00000004h	IEEE 1394A	00020000h – 0002FFFFh	Defined by SFF
00000005h	Fibre Channel	00030000h – 0003FFFFh	Defined by IEEE
00000006h	IEEE 1394B	00040000h – FFFFFFFFh	Reserved
00000007h	Serial ATAPI		

Note 6. It is possible that more than one physical interface exists between the Host and Drive, e.g., an

IEEE1394 Host connecting to an ATAPI bridge to an ATAPI Drive. The Drive may not be aware of interfaces beyond the ATAPI.

All Drives that conform to this standard shall implement the Core Feature set of commands specified in Table 90.

Table 90 — Core Feature Commands

Op Code	Command Description	Reference
46h	GET CONFIGURATION	6.6
4Ah	GET EVENT STATUS NOTIFICATION	6.7
12h	INQUIRY	6.9
55h	MODE SELECT (10)	6.12
5Ah	MODE SENSE (10)	6.13
03h	REQUEST SENSE	6.29
00h	TEST UNIT READY	6.41

5.3.3 Morphing Feature (0002h)

This Feature identifies the ability of the Drive to notify A Host about operational changes and accept Host requests to prevent operational changes.

Support for this Feature is enabled using the PREVENT ALLOW MEDIUM REMOVAL command (Persistent Bit), and the media status is retrieved using the GET EVENT STATUS NOTIFICATION command.

The Feature descriptor response data to be returned to the Host is defined in Table 91.

Table 91 — Morphing Descriptor Format

Bit Byte	7	6	5	4	3	2	1	0
0	(MSB) Feature Code = 0002h (LSB)							
1								
2	Reserved		Version = 0001b			Persistent	Current	
3	Additional Length = 04h							
4	Reserved					OCEvent	ASYNC	
5	Reserved							
6	Reserved							
7	Reserved							

The Feature Code field shall be set to 0002h.

The Version Field shall be set to 0001b.

The Persistent bit shall be set to one.

The Current bit shall be set to one.

The Additional Length field shall be set to 4.

OCEvent (Operational Change Request/Notification Class Events) shall be set to one. OCEvent set to zero is legacy (see).

The ASYNC bit, when set to zero, indicates that the Drive supports only the polling implementation of GET EVENT STATUS NOTIFICATION. When set to one, indicates that the Drive supports both polling and asynchronous GET EVENT STATUS NOTIFICATION. ATAPI implementations shall set ASYNC to 0.

Drives that support this Feature shall implement the commands specified in Table 92.

Table 92 — Morphing Feature Commands

Op Code	Command Description	Reference
46h	GET CONFIGURATION	6.6
4Ah	GET EVENT STATUS NOTIFICATION	6.7
1Eh	PREVENT ALLOW MEDIUM REMOVAL (with Persistent bit set to one)	6.14

5.3.4 Removable Medium Feature (0003h)

This Feature identifies a Drive that has a medium that is removable. Media shall be considered removable if it is possible to remove it from the loaded position, i.e., a single mechanism changer, even if the media is captive to the changer.

The Drive shall generate Events for media changes. Event Notification Class 4 (Media Events) shall be supported. This includes reporting user requests to load/eject the medium.

The Feature descriptor response data to be returned is defined in Table 93.

Table 93 — Removable Medium Feature Descriptor Format

Bit Byte	7	6	5	4	3	2	1	0
0	(MSB) Feature Code = 0003h (LSB)							
1								
2	Reserved		Version = 0000b			Persistent	Current	
3	Additional Length = 04h							
4	Loading Mechanism Type			Reserved	Eject	Pvnt Jmpr	Reserved	Lock
5	Reserved							
6	Reserved							
7	Reserved							

The Feature Code field shall be set to 0003h.

The Version Field shall be set to 0000b.

The Persistent bit shall be set to one.

The Current bit shall be set to one.

The Additional Length field shall be set to 4.

If Lock is set to zero, there is no locking mechanism for locking the medium into the Drive. If Lock is set to one, the Drive is capable of locking the media into the Drive.

The Pvnt Jmpr bit, when set to zero, shall indicate that the Prevent Jumper is present. The Drive shall power up to the allow state and locking the Drive with the PREVENT ALLOW MEDIUM REMOVAL command shall not prevent insertion of the media. When set to one, the Prevent Jumper is not present. The Drive shall power up to the prevent state (locked) and shall not accept new media or allow the ejection of media already loaded until a PREVENT ALLOW MEDIUM REMOVAL (allow) command is issued. The Pvnt Jmpr bit shall not change state, even if the physical jumper is added or removed during operation. Drives that do not have a Prevent Jumper available should set this bit to 0 to indicate that the Drive behaves as described for a jumper being present.

The Eject bit, when set to zero, indicates that the device is unable to eject the medium or magazine via the normal START/STOP command with the LoEj bit set. When set to one, indicates that the device is able to eject the medium or magazine.

The Loading Mechanism Type field (Table 94) shall be set according to the Eject bit.

Table 94 — Loading Mechanism Type

Loading Mechanism Type	Description
000b	Caddy/Slot type loading mechanism
001b	Tray type loading mechanism
010b	Pop-up type loading mechanism
011b	Reserved
100b	Embedded changer with individually changeable discs
101b	Embedded changer using a magazine mechanism
110b – 111b	Reserved

Event Class 4 shall be supported.

Drives that support the Removable Medium Feature shall implement the commands specified in Table 95.

Table 95 — Removable Medium Feature Commands

Op Code	Command Description	Reference
BDh	MECHANISM STATUS	6.11
1Eh	PREVENT ALLOW MEDIUM REMOVAL with the Persistent Prevent bit set to zero.	6.14
1Bh	START STOP UNIT and load eject (LoEj) bit	6.39

If a changer type Drive uses media status operation, it shall use the following variations. If the changer Drive supports individual slot load and unload capability, the slot number(s) exhibiting the media status change shall be reported in the slot fields of the Media Status Event Data. If the changer Drive uses a magazine load mechanism, the slot fields shall be set to the start and end slot numbers present in the magazine.

For non-immediate GET EVENT STATUS NOTIFICATION commands, the Host should use exactly one GET EVENT STATUS NOTIFICATION request for the entire changer Drive. The Drive shall respond as indicated in the Asynchronous Operation section above, indicating the slot information in the Request Sense Data as described above.

5.3.5 Write Protect Feature (0004h)

This Feature identifies reporting capability and changing capability for Write protection status of the Drive. The Write Protect Feature descriptor response data to be returned to the Host is defined in Table 96.

Table 96 — Write Protect Feature Descriptor

Bit	7	6	5	4	3	2	1	0
0	(MSB) Feature Code = 0004h (LSB)							
1								
2	Reserved		Version = 0010b			Persistent	Current	
3	Additional Length = 04h							
4	Reserved			DWP	WDCB	SPWP	SSWPP	
5	Reserved							
6	Reserved							
7	Reserved							

The Feature Code field shall be set to 0004h.

The Version Field shall be set to 0010b.

The Persistent bit shall be defined as in 5.2.2.3.

The Current bit, when set to zero, indicates that this Feature is not currently active and that the Feature dependent data may not be valid. When set to one, this Feature is currently active and the Feature dependent data is valid.

The Current bit, when set to one, indicates that Drive is capable of changing some write protect status on the medium surface. This bit shall be set to zero if the Drive is unable to set/release some write protect status on the medium surface. The reporting capability of the Write Protect status is persistent and shall be supported regardless of the setting of the Current bit.

The Additional Length field shall be set to 04h.

If SSWPP is set to one, the Drive supports the SWPP bit of the Timeout & Protect Mode Page. If SSWPP is set to zero, the Drive claims no support of the SWPP bit of the Timeout & Protect Mode Page. The setting of SSWPP does not affect the Current bit of this Feature Descriptor.

If SPWP is set to one, the Drive supports set/release of PWP status. If SPWP is set to zero, the Drive claims no ability to change PWP status.

The WDCB bit indicates that the Drive supports writing the Write Inhibit DCB on DVD+RW media. If WDCB is set to one, the READ/SEND DISC STRUCTURE command with format code = 30h shall be supported.

The DWP bit indicates that the Drive supports reading/writing the Disc Write Protect PAC on BD-R/-RE media. If DWP is set to one, the READ/SEND DISC STRUCTURE command with format code = 30h shall be supported.

If the Drive supports reporting Write Protection status but does not support changing, the Drive returns this Feature descriptor, however the Current bit is never set to one in the descriptor.

Drives with installed medium that support this Feature shall implement the commands listed in Table 97.

Table 97 — Write Protect Feature Commands

Op Code	Command Description	Reference
ADh	READ DISC STRUCTURE when Media type=0 Format code C0h when WDCB = 0 Format codes 30h and C0h when WDCB = 1	6.23
	READ DISC STRUCTURE when Media type=1 Format codes 30h, C0h when DWP = 1	6.23
BFh	SEND DISC STRUCTURE when Media type=0 Format code C0h when SPWP = 1 Format code 30h when WDCB = 1	6.33
	SEND DISC STRUCTURE when Media type=1 Format codes 30h when DWP = 1	6.33

5.3.6 Random Readable Feature (0010h)

This Feature identifies a Drive that is able to read data from logical blocks referenced by Logical Block Addresses, but not requiring that either the addresses or the read sequences occur in any particular order.

The Feature descriptor response data to be returned to the Host is defined in Table 98.

Table 98 — Random Readable Feature Descriptor Format

Bit Byte	7	6	5	4	3	2	1	0
0	(MSB) Feature Code = 0010h							
1	(LSB)							
2	Reserved		Version = 0000b			Persistent	Current	
3	Additional Length = 08h							
4	(MSB)							
5	Logical Block Size							
6								
7	(LSB)							
8	(MSB)							
9	Blocking							
	(LSB)							
10	Reserved							PP
11	Reserved							

The Feature Code field shall be set to 0010h.

The Version Field shall be set to 0000b.

The Persistent bit shall be defined as in 5.2.2.3.

The Current bit shall be defined as in 5.2.2.4.

The Additional Length field shall be set to 8.

The Logical Block Size shall be set to the number of bytes per logical block. This is the value reported by the READ CAPACITY command.

The Blocking field shall indicate the number of logical blocks per device readable unit. For most hard disks, this value is 1. For DVD media, this number is 10h. For HD DVD media and BD media, this number is 20h. Reads of any sector or sector count, shall be allowed. If there is more than one Blocking on the medium possible, the Blocking field shall be set to zero. See the READ TRACK INFORMATION command for more information.

The PP (Page Present) bit, when set to zero, shall indicate that the Read/Write Error Recovery Mode Page may not be present. When set to one, shall indicate that the Read/Write Error Recovery Mode Page is present.

If the PP bit in the Feature Descriptor is set, the TB, RC, PER, DTE, and DCR bits of the Read/Write Error Recovery Mode Page shall be supported. An Error Recovery Parameter field of 0 in the Read/Write Error Recovery Mode Page shall be supported. Support for other bits and values in the Read/Write Error Recovery Mode Page are optional.

Drives that claim the Random Readable Feature shall implement the commands specified in Table 99.

Table 99 — Random Readable Feature Commands

Op Code	Command Description	Reference
25h	READ CAPACITY	6.19
28h	READ (10)	6.15

Drives that claim the Random Readable Feature shall implement the mode pages as specified in Table 100.

Table 100 — Random Readable Feature Mode Pages

Page Code	Mode Page	Reference
01h	Read/Write Error Recovery Parameters, TB, RC, PER, DTE, and DCR bits (mandatory only when PP is set to one)	7.3

5.3.7 Multi-Read Feature (001Dh)

The Drive shall conform to the OSTA Multi-Read specification 1.00, with the exception of CD Play capability (the CD Audio Feature is not required).

The Feature descriptor response data to be returned to the Host is defined in Table 101.

Table 101 — Multi-Read Feature Descriptor Format

Bit Byte	7	6	5	4	3	2	1	0
0	(MSB) Feature Code = 001Dh (LSB)							
1								
2	Reserved		Version = 0000b			Persistent	Current	
3	Additional Length = 00h							

The Feature Code field shall be set to 001Dh.

The Version Field shall be set to 0000b.

The Persistent bit shall be defined as in 5.2.2.3.

The Current bit shall be defined as in 5.2.2.4.

The Additional Length field shall be set to 00h.

Drives that support the Multi-Read Feature shall implement the commands specified in Table 102

Table 102 — Multi-Read Feature Commands

Op Code	Command Description	Reference
28h	READ (10)	6.15
BEh	READ CD	6.20
51h	READ DISC INFORMATION	6.22
52h	READ TRACK INFORMATION	6.26

5.3.8 CD Read Feature (001Eh)

This Feature identifies a Drive that is able to read CD specific information from the media and is able to read user data from all types of CD sectors.

The Feature descriptor response data to be returned to the Host is defined in Table 103.

Table 103 — CD Read Feature Descriptor Format

Bit Byte	7	6	5	4	3	2	1	0
0	(MSB) Feature Code = 001Eh (LSB)							
1								
2	Reserved		Version = 0010b			Persistent	Current	
3	Additional Length = 04h							
4	DAP	Reserved				C2 Flags	CD-Text	
5	Reserved							
6	Reserved							
7	Reserved							

The Feature Code field shall be set to 001Eh.

The Version field shall be set to 0010b.

The Persistent bit shall be defined as in 5.2.2.3.

The Current bit shall be defined as in 5.2.2.4.

The Additional Length field shall be set to 04h.

If DAP is set to one, the READ CD and READ CD MSF commands support the DAP bit in bit 1, byte 1 of the CDB.

The C2 Flags, when set to one, indicates the Drive supports the C2 Error Pointers. When set to zero the Drive does not support C2 Error Pointers.

The CD-Text bit, when set to one, indicates the Drive supports Format Code 5h of the READ TOC/PMA/ATIP command. When set to zero, CD-Text is not supported.

Drives that read CD-ROM media shall support the commands specified in Table 104.

Table 104 — CD READ Feature Commands

Op Code	Command Description	Reference
BEh	READ CD	6.20
B9h	READ CD MSF	6.21
43h	READ TOC/PMA/ATIP (Format codes 0h, 1h, and 2h shall be supported. If the CD-TEXT bit is set to one, Format code 5h shall also be supported.)	6.25

5.3.9 DVD Read Feature (001Fh)

This Feature identifies a Drive that is able to read DVD specific information from the media.

The Feature descriptor response data to be returned to the Host is defined in Table 105.

Table 105 — DVD Read Feature Descriptor Format

Bit Byte	7	6	5	4	3	2	1	0
0	(MSB) Feature Code = 001Fh (LSB)							
1								
2	Reserved		Version = 0001b			Persistent	Current	
3	Additional Length = 04h							
4	Reserved						MULTI110	
5	Reserved							
6	Reserved						Dual-R	
7	Reserved							

The Feature Code field shall be set to 001Fh.

The Version Field shall be set to 0001b.

The Persistent bit shall be defined as in 5.2.2.3.

The Current bit shall be defined as in 5.2.2.4.

The Additional Length field shall be set to zero.

If MULTI110 is set to one, the Drive shall be compliant with the DVD Multi Drive Read-only specifications as defined in [DVD-Ref8].

If the DVD-R Dual Layer (Dual-R) bit is set to one, Drive shall support reading capability all recording formats of Dual-R disc including Remapping.

Drives that read DVD-ROM media shall support the commands specified in Table 106.

Table 106 — DVD READ Feature Commands

Op Code	Command Description	Reference
28h	READ (10)	6.15
A8h	READ (12)	6.16
ADh	READ DISC STRUCTURE (format codes 00h, 01h, 03, and 04h)	6.23
43h	READ TOC/PMA/ATIP (Supports Format codes 0h and 1h.)	6.25

5.3.10 Random Writable Feature (0020h)

This Feature identifies a Drive that is able to write data to logical blocks specified by Logical Block Addresses. There is no requirement that the addresses in sequences of writes occur in any particular order. The Feature descriptor response data to be returned to the Host is defined in Table 107.

Table 107 — Random Writable Feature Descriptor Format

Bit Byte	7	6	5	4	3	2	1	0
0	(MSB) Feature Code = 0020h (LSB)							
1								
2	Reserved		Version = 0001b			Persistent	Current	
3	Additional Length = 0Ch							
4	(MSB) Last Logical Block Address (LSB)							
5								
6								
7								
8	(MSB) Logical Block Size (LSB)							
9								
10								
11								
12	(MSB) Blocking (LSB)							
13								
14	Reserved						PP	
15	Reserved							

The Feature Code field shall be set to 0020h.

The Version field shall be set to 0001b.

The Persistent bit shall be defined as in 5.2.2.3.

The Current bit shall be defined as in 5.2.2.4.

The Additional Length field shall be set to 0Ch.

The Last Logical Block Address is the logical block address of the last addressable block on the medium.

The Logical Block Size field specifies the number of bytes per logical block. This value shall be the same as reported by the Random Readable Feature and the READ CAPACITY command.

The Blocking field shall indicate the number of logical blocks per writable unit. For DVD media, this number is 10h. For HD DVD media and BD media, this number is 20h. Writes of any sector or sector count, shall be allowed. If there is more than one Blocking on the medium possible, the Blocking field shall be set to zero. See the READ TRACK INFORMATION command for more information.

When the PP (Page Present) bit is set to zero, the Drive does not claim to support the Read/Write Error Recovery Mode Page. When PP is set to one, the Read/Write Error Recovery Mode Page shall be supported.

Drives that may be used as a random writable block device shall implement the commands as specified in Table 108.

Table 108 — Random Writable Feature Commands

Op Code	Command Description	Reference
25h	READ CAPACITY	6.19
2Ah	WRITE (10)	6.43
2Eh	WRITE AND VERIFY (10)	6.45
35h	SYNCHRONIZE CACHE (The Immediate bit shall be supported)	6.40

Drives that claim the Random Writable Feature shall implement the mode pages specified in Table 109.

Table 109 — Random Writable Feature Mode Pages

Page Code	Mode Page	Reference
01h	Read/Write Error Recovery Parameters (mandatory only when PP is set to one)	7.3

5.3.11 Incremental Streaming Writable Feature (0021h)

The Incremental Streaming Writable Feature identifies a Drive that is able to write data to a contiguous region, and is able to append data to a limited number of locations on the media. On CD media, this is known as packet recording, on DVD and HD DVD media it is known as Incremental Recording, and on a BD-R disc it is known as SRM recording. The Feature descriptor response data is defined in Table 110.

Table 110 — Incremental Streaming Writable Feature Descriptor Format

Bit	7	6	5	4	3	2	1	0
Byte								
0	(MSB) Feature Code = 0021h (LSB)							
1								
2	Reserved			Version = 0011b			Persistent	Current
3	Additional Length = 4							
4	(MSB) Data Block Types Supported (LSB)							
5								
6	Reserved				TRIO	ARSV	BUF	
7	Number of Link Sizes (L)							
8	Link Size							
9	Link Size							
...	...							
L+7	Link Size							
L+7+P	4 - (L MOD 4) Zero Pad bytes to ensure a structure size that is an integral multiple of 4							

The Feature Code field shall be set to 0021h.

The Version field is set to 0011b.

The Persistent bit shall be defined as in 5.2.2.3.

The Current bit shall be defined as in 5.2.2.4.

The Additional Length field shall be set to 4 + (Number of Link Sizes) + (Number of Pad bytes).

The Data Block Types Supported field is a bit field that identifies the supported Data Types as defined in the Write Parameters Mode Page description. A bit set to zero indicates the Data Type is not supported. A bit set to one indicates the Data Type is supported. Bit 0 represents Data Type 0, bit 1 represents Data Type 1, etc.

TRIO provides a way for the Drive to report its support for the Track Resources Information of the READ DISC INFORMATION command and the Open bit of READ TRACK INFORMATION command.

ASRV provides a way for the Drive to report its support for Address Mode reservation of the RESERVE TRACK command.

Note 7. Both TRIO and ASRV are media type dependent.

If the BUF bit is set to 1, the Drive is capable of zero loss linking.

The Number of Link Sizes shall specify the number of link sizes available for the current media. For most media, this field should be 1. If the only available link size is zero, then this field may be zero. If both zero and at least one non-zero link size are available, then zero shall be reported as a link size.

Each Link Size field shall indicate the number of logical blocks per link. Links occur on sequentially written media between independent write operations. The link size does not include any logical blocks written by the Drive to satisfy the writable unit specified by the Blocking field in the Random Readable Feature. There is exactly one link size for writable CD media, 7. Writable DVD-R/-RW media may report a link size of 1 and/or 16. The order for reporting Link Size fields is determined solely according to Drive implementation.

The Pad field shall contain zeros. The number of Pad bytes shall be 4 - (Number of Link Sizes MODULO 4). The Pad field is present to make the length of the Feature Descriptor a multiple of 4 bytes.

If a Drive reports this feature with the Current bit set to one, then the Drive shall support the commands shown in Table 111.

Table 111 — Command Support Required by the Incremental Streaming Writable Feature

Op Code	Command Description	Reference
A1h	BLANK (Mandatory when either the Restricted Overwrite Feature or the Rigid Restricted Overwrite Feature is current when this feature is current and is mandatory only for CD-RW and DVD-RW. If supported, Blanking Types 000b, 001b, and 100b are mandatory for CD-RW and Blanking Types 000b and 001b are mandatory for DVD-RW. Shall not be supported by: DVD+R/+RW, BD-R/-RE, and HD DVD-RAM.)	6.2
5Bh	CLOSE TRACK/SESSION	6.3
51h	READ DISC INFORMATION	6.22
52h	READ TRACK INFORMATION	6.26
53h	RESERVE TRACK	6.30
54h	SEND OPC INFORMATION (Shall be supported if OPC information is ever returned in the READ DISC INFORMATION return data.)	6.35
35h	SYNCHRONIZE CACHE	6.40
2Ah	WRITE (10)	6.43

Drives that support this Feature shall implement the mode pages shown in Table 112.

Table 112 — Incremental Streaming Writable Feature Parameters

Page Code	Mode Page	Reference
05h	Write Parameters (Use of this mode page is not defined for BD)	7.5

5.3.12 Sector Erasable Feature (0022h)

This Feature identifies a Drive that supports erasable media and media that require an erase pass before overwrite, such as some magneto-optical technologies. This Feature does not apply to media with direct overwrite technology (e. g. CD-RW, DVD-RAM).

The Feature descriptor response data to be returned to the Host is defined in Table 113.

Table 113 — Sector Erasable Feature Descriptor Format

Bit Byte	7	6	5	4	3	2	1	0
0	Feature Code = 0022h							
1								
2	Reserved		Version = 0000b			Persistent	Current	
3	Additional Length							

The Feature Code field shall be set to 0022h.

The Version field shall be set to 0000b.

The Persistent bit shall be defined as in 5.2.2.3.

The Current bit shall be defined as in 5.2.2.4.

The Additional Length field shall be set to 00h.

Drives that support this Feature shall implement the commands listed in Table 114.

Table 114 — Sector Erasable Feature Commands

Op Code	Command Description	Reference
2Ch	ERASE(10)	6.4
2Fh	VERIFY (10) (The BLKVFY bit shall be supported.)	6.42
2Ah	WRITE (10) (The EBP bit shall be supported.)	6.43

5.3.13 Formattable Feature (0023h)

This Feature identifies a Drive that **is able to** format media into logical blocks. The Feature descriptor response data to be returned to the Host is defined in Table 115.

Table 115 — Formattable Feature Descriptor

Bit	7	6	5	4	3	2	1	0
0	Feature Code = 0023h							
1								
2	Reserved		Version = 0001b			Persistent	Current	
3	Additional Length = 8							
4	Options for formatting BD-RE							
	Reserved			RENoSA	Expand	QCert	Cert	
5	Reserved							
6	Reserved							
7	Reserved							
8	Options for formatting BD-R							
	Reserved						RRM	
9	Reserved							
10	Reserved							
11	Reserved							

The Feature Code field shall be set to 0023h.

The Version field shall be set to 0001b.

Version 0000b of this feature shall be considered compliant with this standard.

The Persistent bit shall be defined as in 5.2.2.3.

The Current bit, when set to zero, indicates that this Feature is not currently active and that the Feature dependent data may not be valid. When set to one, this Feature is currently active and the Feature dependent data is valid. If a blank BD-R disc or a write enabled rewritable disc is present and the response to the TEST UNIT READY command is GOOD status, then the Current bit of this feature shall be set to one.

The Additional Length field shall be set to 8.

If the BD-RE Profile is supported, the FORMAT UNIT command shall support Format Types 00h and 30h with Sub-type 00b. Quick Reformat shall be supported.

If the Cert bit is set to zero, the Drive does not support Sub-type 10b (Full Certification) on formatting BD-RE disc. If the Cert bit is set to one, Format Type 30h with Sub-type 10b shall be supported for BD-RE disc.

If the Qcert bit is set to zero, the Drive does not support Sub-type 11b (Quick Certification) during formatting of previously formatted BD-RE disc. If the QCert bit is set to one, Format Type 30h with Sub-type 11b shall be supported for BD-RE disc.

If the Expand bit is set to zero, the Drive does not support Format Type 01h (Spare Area Expansion). If the Expand bit is set to one, Format Type 01h is supported for the expansion of the spare area on formatted BD-RE discs.

If the RENoSA bit is set to zero, Format Type 31h (BD-RE with no spares allocated) is not supported for BD-RE disc. If the RENoSA bit is set to one, Format Type 31h shall be supported for BD-RE disc.

If any BD-R Profiles are supported, then when a blank BD-R disc is present and ready:

1. If a WRITE (10), WRITE (12), WRITE AND VERIFY (10), WRITE AND VERIFY (12), or RESERVE TRACK command is sent to the Drive, then the disc shall be formatted as SRM with no spare areas allocated.
2. If the FORMAT UNIT command is used to select a BD-R format, SRM with defect management shall be an option (Sub-types 00b and 01b of Format Types 00h and 32h).
3. If the FORMAT UNIT command is used to select a BD-R format, SRM+POW shall be an option (Sub-type 00b of Format Types 00h and 32h).
4. If the RRM bit is set to one, then the FORMAT UNIT command shall provide RRM as an option (Sub-type 10b of Format Types 00h and 32h).

Drives that support this Feature shall implement the commands listed in Table 116.

Table 116 — Formattable Feature Commands

Op Code	Command	Reference
04h	FORMAT UNIT, Format Types 00h and 32h and sub-types 00b and 01b	6.5
23h	READ FORMAT CAPACITIES	6.24
03h	REQUEST SENSE	6.29
2Fh	VERIFY (10)	6.42

5.3.14 Hardware Defect Management Feature (0024h)

This Feature identifies a Drive that shall have defect management available to provide a defect-free contiguous address space.

The Feature descriptor response data to be returned to the Host is defined in Table 117.

Table 117 — Defect Management Feature Descriptor Format

Bit Byte	7	6	5	4	3	2	1	0
0	(MSB) Feature Code = 0024h (LSB)							
1								
2	Reserved		Version = 0001b			Persistent	Current	
3	Additional Length = 04h							
4	SSA	Reserved						
5	Reserved							
6	Reserved							
7	Reserved							

The Feature Code field shall be set to 0024h.

The Version Field shall be set to 0001b.

The Persistent bit shall be defined as in 5.2.2.3.

The Current bit shall be defined as in 5.2.2.4.

The Additional Length field shall be set to 4h.

An SSA bit of one shall indicate that the Drive supports the READ DISC STRUCTURE command for Media Type code = 0 with Format Code 0Ah (Spare Area Information).

Drives that support this Feature shall implement the commands as specified in Table 118.

Table 118 — Defect Management Feature Commands

Op Code	Command Description	Reference
ADh	READ DISC STRUCTURE, format code 0Ah (mandatory only when SSA is set to one)	6.23

Drives that support this Feature shall implement the mode pages listed in Table 119.

Table 119 — Defect Management Feature Mode Pages

Page Code	Mode Page	Reference
01h	Read/Write Error Recovery Parameters (AWRE and ARRE shall be supported if the medium is Writable.)	7.3

5.3.15 Write Once Feature (0025h)

This Feature identifies a Drive that shall have the ability to record to any previously unrecorded logical block. The recording of logical blocks may occur in any order. Previously recorded blocks shall not be overwritten. The Feature descriptor response data to be returned to the Host is defined in Table 120.

Table 120 — Write Once Feature Descriptor Format

Bit Byte	7	6	5	4	3	2	1	0
0	(MSB) Feature Code = 00025h (LSB)							
1								
2	Reserved		Version = 0000b			Persistent	Current	
3	Additional Length = 08h							
4	(MSB) Logical Block Size (LSB)							
5								
6								
7								
8	(MSB) Blocking (LSB)							
9								
10	Reserved						PP	
11	Reserved							

The Feature Code field shall be set to 25h.

The Version field shall be set to 0000b.

The Persistent bit shall be defined as in 5.2.2.3.

The Current bit shall be defined as in 5.2.2.4.

The Additional Length field shall be set to 08h.

The Logical Block Size is the number of bytes per logical block. This value shall be the same as reported by the Random Readable Feature and the READ CAPACITY command.

The Blocking field shall indicate the number of logical blocks per Drive writable unit. For most hard disks, this value is 1. For DVD devices, this number is 10h. The Blocking field reported in the Feature Descriptor is for performance optimization only. A write of any sector or sector count shall be allowed.

If there is more than one Blocking on the medium possible, the Blocking field shall be set to zero. See the READ TRACK INFORMATION command for more information.

When the PP (Page Present) bit is set to zero, the Drive does not claim to support the Read/Write Error Recovery Mode Page. When PP is set to one, the Read/Write Error Recovery Mode Page shall be supported.

Drives that support this Feature shall implement the commands listed in Table 121.

Table 121 — Write Once Feature Commands

Op Code	Command Description	Reference
25h	READ CAPACITY	6.19
35h	SYNCHRONIZE CACHE	6.40
2Ah	WRITE (10)	6.43
2Eh	WRITE AND VERIFY (10)	6.45

Drives that support this Feature shall implement the mode pages as specified in Table 122.

Table 122 — Write Once Feature Mode Pages

Page Code	Mode Page	Reference
01h	MM Read/Write Error Recovery Parameters (Mandatory only when PP is set to one)	7.3

5.3.16 Restricted Overwrite Feature (0026h)

This Feature identifies a Drive that shall have the ability to overwrite logical blocks only in fixed sets at a time. The Feature descriptor response data to be returned to the Host is defined in Table 123.

Table 123 — Restricted Overwrite Feature Descriptor Format

Bit Byte	7	6	5	4	3	2	1	0
0	(MSB) Feature Code = 0026h (LSB)							
1								
2	Reserved		Version = 0000b			Persistent	Current	
3	Additional Length = 00h							

The Feature Code field shall be set to 0026h.

The Version field shall be set to 0000b.

The Persistent bit shall be defined as in 5.2.2.3. This bit shall be set to zero if the medium is removable.

The Current bit shall be defined as in 5.2.2.4. This bit shall be set to zero if Restricted Overwrite medium is not present.

The Additional Length field shall be set to zero.

Drives that claim this Feature shall support the commands specified in Table 124.

Table 124 — Restricted Overwrite Feature Commands

Op Code	Command Description	Reference
25h	READ CAPACITY	6.19
51h	READ DISC INFORMATION	6.22
52h	READ TRACK INFORMATION	6.26
35h	SYNCHRONIZE CACHE	6.40
2Ah	WRITE (10)	6.43

Drives that claim this Feature shall support the mode pages specified in Table 125.

Table 125 — Restricted Overwrite Feature Mode Pages

Page Code	Mode Page	Reference
05h	Write Parameters	7.5

5.3.17 CD-RW CAV Write Feature (0027h)

This Feature identifies a Drive that has the ability to write CD-RW media that is designed for CAV recording. The Drive shall conform to the Orange Book Part 3 Volume 2 specification. This Feature shall not be current if high-speed recordable CD-RW media is not mounted. Drive with write protected media shall not have this Feature current.

The CD-RW CAV Write Feature descriptor response data to be returned to the Host is defined in Table 126.

Table 126 — CD-RW CAV WRITE Feature Descriptor

Bit Byte	7	6	5	4	3	2	1	0
0	(MSB) Feature Code = 0027h (LSB)							
1								
2	Reserved		Version			Persistent	Current	
3	Additional Length = 04h							
4	Reserved							
5	Reserved							
6	Reserved							
7	Reserved							

The Feature Code field shall be set to 0027h.

The Version field shall be set to zero.

The Persistent bit shall be defined as in 5.2.2.3.

The Current bit shall be defined as in 5.2.2.4.

The Additional Length field shall be set to 04h.

Drives with installed medium that support this Feature shall implement the commands listed in Table 127.

Table 127 — CD-RW CAV Write Feature Commands

Op Code	Command Description	Reference
25h	READ CAPACITY	6.19
51h	READ DISC INFORMATION	6.22
52h	READ TRACK INFORMATION	6.26
35h	SYNCHRONIZE CACHE	6.40
2Ah	WRITE (10)	6.43

Drives with installed medium that support this Feature shall implement the commands listed in Table 128.

Table 128 — CD-RW CAV Write Feature Parameters

Page Code	Parameter	Reference
05h	Write Parameters	7.5

5.3.18 The MRW Feature (0028h)

The presence of the MRW Feature indicates that the Drive is capable of reading a disc with the MRW format. The MRW Feature descriptor response data to be returned to the Host is defined in Table 129.

Table 129 — MRW Feature Descriptor

Bit Byte	7	6	5	4	3	2	1	0
0	(MSB) Feature Code = 0028h (LSB)							
1								
2	Reserved		Version = 0001b			Persistent	Current	
3	Additional Length = 4							
4	Reserved				DVD+ Write	DVD+ Read	CD Write	
5	Reserved							
6	Reserved							
7	Reserved							

The Feature Code field shall be set to 0028h.

The Version field shall be set to 0001b.

The Persistent bit shall be defined as in 5.2.2.3. Since MRW medium is removable Persistent is set to zero.

The Current bit shall be defined as in 5.2.2.4.

Consequently, when Current is set to zero, either no disc is mounted or the disc currently mounted is not a MRW disc, and when Current is set to 1, a disc is mounted and it is a MRW disc.

The Additional Length field shall be set to 04h.

If the CD Write bit is set to one, the Drive claims the ability of formatting CD-RW discs in the MRW format and is capable of writing CD-RW discs that have been MRW formatted. When the CD Write bit is set to one, the Drive shall include the Removable Disk Profile and list all features required of that profile.

If the DVD+ Read bit is set to one, then the Drive claims the ability of reading a DVD+RW disc with the MRW format.

If the DVD+ Write bit is set to one, the Drive claims the ability of formatting DVD+RW discs in the MRW format and is capable of writing DVD+RW discs that have been MRW formatted. When the DVD+ Write bit is set to one, the Drive shall include the Removable Disk Profile and list all features required of that profile.

Drives that support this feature shall implement the commands listed in Table 130.

Table 130 — MRW Feature Commands

Op Code	Command Description	Reference
4Ah	GET EVENT STATUS NOTIFICATION	6.7
28h	READ (10)	6.15
A8h	READ (12)	6.16
25h	READ CAPACITY	6.19
51h	READ DISC INFORMATION	6.22

Drives that support this feature shall implement the mode pages listed in Table 131.

Table 131 — MRW Feature Parameters

Page Code	Parameter	Reference
03h	MRW Mode Page	

Drives that support this feature and its write capabilities shall implement the commands listed in Table 132 in addition to the commands listed in Table 130.

Table 132 — MRW Write Feature Commands

Op Code	Command Description	Reference
5Bh	CLOSE TRACK/SESSION	6.3
04h	FORMAT UNIT	6.5
2Ah	WRITE (10)	6.43
2Eh	WRITE AND VERIFY (10)	6.45
2Fh	VERIFY (10)	6.42
23h	READ FORMAT CAPACITIES	6.24

5.3.19 Enhanced Defect Reporting Feature (0029h)

The Enhanced Defect Reporting Feature identifies a Drive that has the ability to perform media certification and RECOVERED ERROR reporting for Drive assisted software defect management. In case of Persistent-DM mode, the READ (12) command with Streaming bit = 1 may be performed without medium certification.

When this Feature is current, the Hardware Defect Management Feature shall not be current. This Feature may be current when Restricted Overwrite formatted media or Rigid Restricted Overwrite formatted media is present. The Enhanced Defect Reporting Feature descriptor response data to be returned to the Host is defined in Table 133.

Table 133 — Enhanced Defect Reporting Feature Descriptor

Bit Byte	7	6	5	4	3	2	1	0
0	(MSB) Feature Code = 0029h							
1	(LSB)							
2	Reserved		Version = 0000b			Persistent	Current	
3	Additional Length = 4							
4	Reserved						DRT-DM	
5	Number of DBI cache zones							
6	(MSB) Number of entries							
7	(LSB)							

The Feature Code field shall be set to 0029h

The Version field shall be set to 0000b.

The Persistent bit shall be defined as in 5.2.2.3. This bit shall be set to zero if the medium is removable.

The Current bit shall be defined as in 5.2.2.4. This bit shall be set to zero if Hardware Defect Management feature is current. This bit is not affected by the EMCDR field and the PER bit settings.

When this Feature is current, Hardware Defect Management Feature shall not be current. This Feature may be current if Restricted Overwrite formatted media or Rigid Restricted Overwrite formatted media is loaded.

The Additional Length field shall be set to 04h.

The Feature Code field shall be set to 0029h.

DRT-DM bit, if set to 1, shall indicate that the Drive supports DRT-DM mode. If set to 0, shall indicate that the Drive supports Persistent-DM mode.

Number of DBI cache zones field specifies possible maximum number of regions that Drive is able to handle DBI cache separately. If this field is set to 0, shall indicate that Drive supports "Simple DBI memory model" (see 4.7.4.5.2). If this field is set to 1, shall indicate that Drive supports "Large DBI buffer memory model" (see 4.7.4.5.3). In case of "Small DBI cache memory model" (see 4.7.4.5.4), the Number of DBI cache zones field shall be set to 2 or higher (minimum number of this field is 2). The value of Number of DBI cache zones field may be changed by media type. If the Feature is not current, this field is invalid.

Table 134 — Relation between Number of DBI cache zones and DBI memory model type

DRT-DM	Number of DBI cache zones field value	Number of entries	DBI buffer model type of Drive
0	0	m (≥ 10)	simple memory model, cleared at the beginning of medium certification
0	1	0	large DBI buffer model
0	2 or higher	m (≥ 10)	small DBI cache model
1	0	N/A	Reserved
1	1	0	large DBI buffer model
1	2 or higher	m (≥ 10)	small DBI cache model

Number of entries filed indicates that the number of entries that in the worst case may cause DBI memory overflow. In case of large DBI buffer model, this field shall be set to zero. For other DBI memory model, this field shall be set to 10 or higher. The value of this field may be changed by media type. If this Feature is not current, this field is invalid.

Drives that support this feature shall implement the commands listed in Table 135.

Table 135 — Enhanced Defect Reporting Feature Commands

Op Code	Command Description	Reference
4Ah	GET PERFORMANCE with Type = 4	6.8
28h	READ (10)	6.15
A8h	READ (12) with Streaming bit =0	6.16
51h	READ DISC INFORMATION	6.22
2Ah	WRITE (10)	6.43
AAh	WRITE (12) with Streaming bit =0	6.44
2Fh	VERIFY (10)	6.42
2Eh	WRITE AND VERIFY (10)	6.45
35h	SYNCHRONIZE CACHE with Implicit Sync Cache	6.40

Drives that support this feature shall implement the mode pages listed in Table 136.

Table 136 — Enhanced Defect Reporting Feature Parameters

Page Code	Parameter	Reference
01h	PER bit and EMCDR field in Read/Write Error Recovery Parameters Mode Page	7.3

Drives that support this feature and have DRT-DM capabilities shall implement the commands listed in Table 117 in addition to the commands listed in Table 137.

Table 137 — Enhanced Defect Reporting DRT-DM Feature Commands

Op Code	Command Description	Reference
A8h	READ (12) with Streaming bit =1	6.16
AAh	WRITE (12) with Streaming bit =1	6.44

Drives that support this feature and if small DBI cache memory model is supported, shall implement the commands listed in Table 138 in addition to the commands listed in Table 135.

Table 138 — Enhanced Defect Reporting small DBI cache memory model Feature Commands

Op Code	Command Description	Reference
ACh	GET PERFORMANCE with Type = 4, 5	6.8
B6h	SET STREAMING with Type =5	6.38

5.3.20 DVD+RW Feature (002Ah)

The presence of the DVD+RW Feature indicates that the Drive is capable of reading a recorded DVD+RW disc that is formatted according to [DVD+Ref2]. The DVD+RW Feature descriptor is shown in Table 139.

Table 139 — DVD+RW Feature Descriptor

Bit	7	6	5	4	3	2	1	0
0	(MSB) Feature Code = 002Ah (LSB)							
1								
2	Reserved		Version = 0001b			Persistent	Current	
3	Additional Length							
4	Reserved						Write	
5	Reserved					Quick Start	Close Only	
6	Reserved							
7	Reserved							

The Feature Code field shall be set to 002Ah

The Version field shall be set to 0001b.

The Persistent bit shall be defined as in 5.2.2.3.

The Current bit shall be defined as in 5.2.2.4.

The Additional Length field shall be set to 04h.

This feature may be present only to represent additional capability for the DVD-ROM Profile. If the Write bit is set to zero, then no additional capability is claimed. A device may report this feature only when Profile 10h (DVD-ROM) is reported. No additional commands or mode parameters are required.

If the Write bit is set to one, then the Drive is also capable of background formatting DVD+RW discs according to [DVD+Ref2] and is capable of writing DVD+RW discs that have been formatted according to [DVD+Ref2].

If the Close Only bit is set to zero, then the Drive supports both forms of background format stop. If the Close Only bit is set to one, then the Drive supports only the read compatibility stop.

If the Quick Start bit is zero, the FORMAT UNIT command does not support quick start formatting. If the Quick Start bit is set to one, the FORMAT UNIT command supports quick start formatting.

If a Drive reports this feature with the Write bit set to one and the Current bit is to one, then it shall support the commands shown in Table 140.

Table 140 — Command Support Required by the DVD+RW Feature with Write = 1

Op Code	Write Bit	Command Description	Reference
5Bh	1	CLOSE TRACK/SESSION	6.3
04h	1	FORMAT UNIT	6.5
ADh	-	READ DISC STRUCTURE (format field values 0, 1, 3, 4, 5, 30h, and FFh)	6.23
43h	-	READ TOC/PMA/ATIP	6.25
BFh	1	SEND DISC STRUCTURE (format field value 05h)	6.33
2Ah	1	WRITE (10)	6.43
AAh	1	WRITE (12)	6.44
2Eh	1	WRITE AND VERIFY (10)	6.45

The DVD+RW Feature does not require the use of the Write Parameters Mode Page. If the Write Parameters Mode Page is supported for other media types, the Drive shall accept valid mode selects to the Write Parameters Mode Page. The Host should be aware that the Drive shall ignore the Write Parameters Mode Page when the DVD+RW Feature is current.

5.3.21 DVD+R Feature (002Bh)

The presence of the DVD+R Feature indicates that the Drive is capable of reading a recorded DVD+R disc that is written according to [DVD+Ref1]. Specifically, this includes the capability of reading DCBs. The DVD+R Feature descriptor is shown in Table 141.

Table 141 — DVD+R Feature Descriptor

Bit	7	6	5	4	3	2	1	0
Byte								
0	(MSB)							
1	(LSB)							
2	Reserved		Version = 0000b			Persistent	Current	
3	Additional Length							
4	Reserved						Write	
5	Reserved							
6	Reserved							
7	Reserved							

The Feature Code field shall be set to 002Bh

The Version field shall be set to 0000b.

The Persistent bit shall be defined as in 5.2.2.3.

The Current bit shall be defined as in 5.2.2.4. When Current = 0, either no disc is mounted or the disc currently mounted is not a DVD+R disc. When Current = 1, a disc is mounted and it is a DVD+R disc.

The Additional Length field shall be set to 04h.

This feature may be present only to represent additional capability to the DVD-ROM Profile. If the Write bit is set to zero, then no additional capability is claimed. A device may report this feature only when Profile 10h (DVD-ROM) is reported. No additional commands or mode parameters are required.

If the Write bit is set to one, then the Drive is also capable of writing DVD+R discs according to [DVD+Ref1].

If a Drive reports this feature with the Write bit set to one and the Current bit set to one, then it shall support the commands shown in Table 142.

Table 142 — Command Support Required by the DVD+R Feature with Write = 1

Op Code	Write Bit	Command Description	Reference
5Bh	1	CLOSE TRACK/SESSION	6.3
51h	-	READ DISC INFORMATION	6.22
ADh	-	READ DISC STRUCTURE (format field values 0, 1, 3, 4, 5, 30h, and FFh)	6.23
43h	-	READ TOC/PMA/ATIP	6.25
52h	-	READ TRACK INFORMATION	6.26
53h	1	RESERVE TRACK	6.30
BFh	1	SEND DISC STRUCTURE (format field value 05h)	6.33
35h	1	SYNCHRONIZE CACHE	6.40
2Ah	1	WRITE (10)	6.43
AAh	1	WRITE (12)	6.44

The DVD+R Feature does not require the use of the Write Parameters Mode Page. If the Write Parameters Mode Page is supported for other media types, the Drive shall accept valid mode selects to the Write Parameters Mode Page. The Host should be aware that the Drive shall ignore the Write Parameters Mode Page when the DVD+R Feature is current.

5.3.22 Rigid Restricted Overwrite Feature (002Ch)

This Feature identifies a Drive that has the ability to perform writing only on Blocking boundaries. This Feature is different from the Restricted Overwrite Feature (0026h) because each Write command is also required to end on a Blocking boundary. This Feature replaces the Random Writable Feature for Drives that do not perform read-modify-write operations on write requests smaller than Blocking. This Feature may be present when DVD-RW Restricted Overwritable media is loaded. Drives with write protected media shall not have this Feature current. This Feature shall not be current if the Random Writable Feature is current. If this Feature is current, the Random Writable Feature shall not be current. The Feature descriptor response data is defined in Table 143.

Table 143 — Rigid Restricted Overwrite Feature Descriptor Format

Bit	7	6	5	4	3	2	1	0
Byte								
0	(MSB) Feature Code = 002Ch							(LSB)
1								
2	Reserved		Version = 0000b			Persistent	Current	
3	Additional Length = 04h							
4	Reserved			DSDG	DSDR	Inter- mediate	Blank	
5	Reserved							
6	Reserved							
7	Reserved							

The Feature Code field shall be set to 002Ch.

The Version field shall be set to 0000b.

The Persistent bit shall be defined as in 5.2.2.3.

The Current bit shall be defined as in 5.2.2.4.

The Additional Length field shall be set to 04h.

The Defect Status Data Generate (DSDG) bit, if set to 1, shall indicate that the Drive supports to generate Defect Status data during formatting. A disable certification (DCRT) bit (Table 247) shall be supported. If DSDG is set to 0, the Drive does not support generating of Defect Status Bitmap.

The Defect Status Data Read (DSDR) bit, if set to 1, shall indicate that the Drive supports to read Defect Status data recorded on a medium. A disable certification (DCRT) bit (Table 247) shall be supported. If DSDR is set to 0, the Drive does not support reading of Defect Status data.

The Intermediate bit, if set to 1, shall indicate that the Drive supports writing on an intermediate state Session and quick formatting (Format Type of 15h – Quick Format). If Intermediate is set to 0, the Drive does not support writing on an intermediate state Session and quick formatting.

The Blank bit, if set to 1, shall indicate that the Drive supports BLANK command with Blanking Type 00h and 01h. If Blank is set to 0, the Drive does not support BLANK command.

If more than one Track/Session is present on the media, the Host should use the READ DISC INFORMATION and READ TRACK INFORMATION commands to obtain a description of the medium such as Blocking factor.

Writing from the Host into the media shall be in units of Blocking. Writing shall begin and shall stop at Blocking boundaries. The writable units may be sent via multiple WRITE (10) commands. If a Write does not begin on a Blocking boundary, the Drive shall return CHECK CONDITION status and set SK/ASC/ASCQ values to ILLEGAL REQUEST/INVALID ADDRESS FOR WRITE. If a Write does not end on a Blocking boundary the Drive shall return CHECK CONDITION status and set SK/ASC/ASCQ values to ILLEGAL REQUEST/INVALID FIELD IN CDB.

Drives that support this Feature shall implement the commands identified in Table 144.

Table 144 — Rigid Restricted Overwrite Feature Commands

Op Code	Command Description	Reference
A1h	BLANK with Blanking Type = 00h, 01h (Whenever Blank = 1)	6.2
ACh	GET PERFORMANCE with Type =2 (whenever DSDR = 1)	6.8
51h	READ DISC INFORMATION	6.22
52h	READ TRACK INFORMATION	6.26
25h	READ CAPACITY	6.19
35h	SYNCHRONIZE CACHE	6.40
2Fh	VERIFY (10)	6.42
2Ah	WRITE (10)	6.43

5.3.23 CD Track at Once Feature (002Dh)

This Feature identifies a Drive that is able to write data to a CD track.

The Feature descriptor response data to be returned to the Host is defined in Table 145.

Table 145 — CD Track at Once Feature Descriptor Format

Bit Byte	7	6	5	4	3	2	1	0
0	(MSB) Feature Code = 002Dh (LSB)							
1								
2	Reserved		Version = 0010b			Persistent	Current	
3	Additional Length = 04h							
4	Resvd	BUF	Resvd	R-W Raw	R-W Pack	Test Write	CD-RW	R-W Sub-code
5	Reserved							
6	(MSB) Data Type Supported (LSB)							
7								

The Feature Code field shall be set to 002Dh.

The Version Field shall be set to 0010b.

The Persistent bit shall be defined as in 5.2.2.3.

The Current bit shall be defined as in 5.2.2.4.

The Additional Length field shall be set to 04h.

The following bits indicate Feature support. When the bit is zero, the Feature is not supported. When the bit is one, the Feature is supported.

The BUF bit, if set to 1, shall indicate that the Drive is capable of zero loss linking.

The R-W Raw bit, if set to 1, shall indicate that the Drive supports writing R-W Sub code in the Raw mode. The R-W Sub-code bit shall be set if this bit is set.

The R-W Pack bit, if set to 1, shall indicate that the Drive supports writing R-W Sub code in the Packed mode. The R-W Sub-code bit shall be set if this bit is set.

The Test Write bit indicates that the Drive is able to perform test writes. See 7.5. The CD-RW bit indicates support for overwriting a Track at Once track with another.

The R-W Sub-code bit indicates that the Drive is able to record the R-W Sub-channels with user supplied data.

The Data Type Supported field is defined in 5.3.11.

Drives that support this Feature shall implement the commands and Features identified in Table 146.

Table 146 — CD Track at Once Feature Commands

Op Code	Command Description	Reference
A1h	BLANK (Blanking Type 000b, 001b, and 100b shall be implemented if the currently mounted media is CD-RW.)	6.2
5Bh	CLOSE TRACK/SESSION	6.3
51h	READ DISC INFORMATION	6.22
52h	READ TRACK INFORMATION	6.26
53h	RESERVE TRACK	
54h	SEND OPC INFORMATION (Shall be implemented if OPC Information is returned in the READ DISC INFORMATION returned data.)	6.35
35h	SYNCHRONIZE CACHE	6.40
2Ah	WRITE (10)	6.43

Drives that support this Feature shall implement the mode pages identified in Table 147.

Table 147 — CD Track at Once Feature Mode Parameters

Page Code	Mode Page	Reference
05h	Write Parameters	7.5

5.3.24 CD Mastering (Session at Once) Feature (002Eh)

This Feature identifies a Drive that is able to write a CD in Session at Once or Raw mode.

The Feature descriptor response data to be returned to the Host is defined in Table 148.

Table 148 — CD Mastering Feature Descriptor

Bit Byte	7	6	5	4	3	2	1	0
0	Feature Code = 002Eh (MSB) (LSB)							
1								
2	Reserved		Version = 0001b			Persistent	Current	
3	Additional Length = 04h							
4	Resvd	BUF	SAO	Raw MS	Raw	Test Write	CD-RW	R-W
5	Maximum Cue Sheet Length (MSB) (LSB)							
6								
7								

The Feature Code field shall be set to 002Eh.

The Version Field shall be set to 0001b.

The Persistent bit shall be defined as in 5.2.2.3.

The Current bit shall be defined as in 5.2.2.4.

The Additional Length field shall be set to 04h.

The following bits indicate Feature support. If zero, the Feature is not supported. If one, the Feature is supported.

If BUF is zero, the Drive does not claim the ability of zero loss linking. If BUF is one, the Drive is capable of zero loss linking.

If SAO is zero, the Drive does not claim the ability of recording the Session At Once write type. If SAO is one, the Drive is capable of recording the Session at Once write type.

If Raw MS is zero, the Drive does not claim the ability of recording multi-session in raw mode. If Raw MS is one, the Drive is capable of recording multi-session in raw mode.

If Raw is zero, the Drive does not claim the ability of recording in the raw write type. If Raw is one, the Drive is capable of recording using the raw write type.

If Test Write is zero, the Drive does not claim the ability to perform Test Writing. If Test Write is one, the Drive is capable of performing Test Writing.

If CD-RW is zero, the Drive does not claim the ability to record and overwrite CD-RW media. If CD-RW is one, the Drive is capable if writing and overwriting on CD-RW media.

If R-W is zero, the Drive does not claim the ability to record R-W sub-channels with user supplied data. If R-W is one, the Drive is capable of recording the R-W Sub-channels with user supplied information.

The Maximum Cue Sheet Length field indicates the maximum length of a Cue Sheet that is possible to be accepted by the Drive for Session at Once recording. If the SAO bit is zero, this field shall be set to zero.

Drives that support Session at Once mastering shall implement the commands listed in Table 149.

Table 149 — CD Mastering (Session at Once) Feature Commands

Op Code	Command Description	Reference
51h	READ DISC INFORMATION	6.22
52h	READ TRACK INFORMATION	6.26
5Dh	SEND CUE SHEET	6.32
54h	SEND OPC INFORMATION (Shall be implemented if OPC Information is returned in the READ DISC INFORMATION returned data.)	6.35
2Ah	WRITE (10)	6.43

Drives that support Session at Once mastering shall implement the parameters listed in Table 150.

Table 150 — CD Mastering (Session at Once) Feature Mode Parameters

Page Code	Parameter	Reference
05h	Write Parameters – Session-At-Once Write type shall be supported.	7.5

Drives that support mastering in RAW mode shall implement the commands listed in Table 151.

Table 151 — CD Mastering (RAW) Feature Commands

Op-Code	Command	Reference
51h	READ DISC INFORMATION	6.22
52h	READ TRACK INFORMATION	6.26
35h	SYNCHRONIZE CACHE	6.40
2Ah	WRITE (10)	6.43

Drives that support mastering in RAW mode shall implement the parameters listed in Table 152.

Table 152 — CD Mastering (RAW) Feature Mode Parameters

Page Code	Parameter	Reference
05h	Write Parameters <ul style="list-style-type: none"> • RAW Write Type shall be supported • Data Block Type 2 and 3 shall be supported when R-W bit is set to one. 	7.5

5.3.25 DVD-R/-RW Write Feature (002Fh)

This Feature identifies a Drive that has the ability to write data to DVD-R/-RW in Disc at Once mode. The DVD-R/-RW Write Feature descriptor response data to be returned to the Host is defined in Table 153.

Table 153 — DVD-R/-RW Write Feature Descriptor Format

Bit Byte	7	6	5	4	3	2	1	0
0	(MSB) Feature Code = 002Fh (LSB)							
1								
2	Reserved		Version = 0010b			Persistent	Current	
3	Additional Length = 04h							
4	Reserved	BUF	Reserved		RDL	Test Write	DVD-RW	Reserved
5	Reserved							
6	Reserved							
7	Reserved							

The Feature Code field shall be set to 002Fh.

The Version Field shall be set to 0010b.

The Persistent bit shall be defined as in 5.2.2.3. This bit shall be set to zero if the medium is removable.

The Current bit shall be defined as in 5.2.2.4. This bit shall be set to zero if DVD-R/-RW media is not present.

The Additional Length field shall be set to 04h.

The BUF bit, when set to one, indicates the Drive is able to perform Buffer Under-run Free recording.

The RDL bit, when set to 1, shall indicate that the Drive supports writing DVD-R Dual Layer media. The READ DISC STRUCTURE command for DVD Media Type with Format Code 20h shall be supported.

The Test Write bit, when set to zero, shall indicate that the Drive is not capable of performing test writes. When set to one, the Drive is capable of performing test writes.

The DVD-RW bit indicates support for writing and erasing on DVD-RW media. If this bit set to one, shall indicate that the Drive supports BLANK command, Blanking Type 00h and 01h.

Drives that write and read DVD-R/-RW media shall support the commands specified in Table 154.

Table 154 — DVD-R/-RW Write Feature Commands

Op Code	Command Description	Reference
A1h	BLANK with Blanking Type 00h and 01h (Shall be implemented if	6.2
51h	READ DISC INFORMATION	6.22
52h	READ TRACK INFORMATION	6.26
53h	RESERVE TRACK	6.30
BFh	SEND DISC STRUCTURE (format field values 04h, 05, and 0Fh)	6.33
2Ah	WRITE (10)	6.43

Drives that write and read DVD-R/-RW media shall support the parameters identified in Table 155.

Table 155 — DVD-R/-RW Write Feature Parameters

Page Code	Parameter	Sub-Reference
05h	Write Parameters - Session at Once Write Type shall be supported	7.5

5.3.26 Layer Jump Recording Feature (0033h)

This Feature identifies a Drive that **is able to** write data to contiguous regions that are allocated on multiple Layers, and **is able to** append data to a limited number of locations on the media. The Drive **may** write two or more recording Layers sequentially and alternately.

The Layer Jump Recording Feature descriptor response data to be returned to the Host is defined in Table 156.

Table 156 — Layer Jump Recording Feature Descriptor

Bit Byte	7	6	5	4	3	2	1	0
0	(MSB) Feature Code = 0033h (LSB)							
1								
2	Reserved		Version = 0000b			Persistent	Current	
3	Additional Length = 04h							
4	Reserved							
5	Reserved							
6	Reserved							
7	Number of Link Sizes (L)							
8	Link Size							
9	Link Size							
...	...							
L+7	Link Size							
L+7+P	4 - (L MOD 4) Zero Pad bytes to ensure a structure size that is an integral multiple of 4							

The Feature Code field shall be set to 0033h.

The Version field shall be set to 0000b.

The Persistent bit shall be defined as in 5.2.2.3.

The Current bit shall be defined as in 5.2.2.4.

The Additional Length field shall be set to 4 + (Number of Link Sizes) + (Number of Pad bytes).

The Number of Link Sizes shall specify the number of link sizes available for the current media.

Each Link Size field shall indicate the number of logical blocks per link. Links occur on sequentially written media between independent write operations. The link size does not include any logical blocks written by the Drive to satisfy the writable unit specified by the Blocking field in the Random Readable Feature. Link Size fields are reported by the Drive in the Drive's preferred order, most desirable first.

For DVD-R Dual Layer Ver. 3.0, this field shall be 1 or 16.

The Pad field shall contain zeros. The number of Pad bytes shall be 4 - (Number of Link Sizes MODULO 4).

The Pad field is present to make the length of the Feature Descriptor a multiple of 4 bytes.

Data Block Type 8 of Write Parameters Mode Page (05h) shall be supported.

Buffer Under-run Free recording shall be available for the current mounted media.

5.3.27 CD-RW Media Write Support Feature (0037h)

This Feature identifies a Drive that has the ability to perform writing CD-RW media. This Feature shall not be current if CD-RW media is not mounted. The CD-RW Media Write Support Feature descriptor response data to be returned to the Host is defined in Table 157.

Table 157 — CD-RW Media Write Support Feature Descriptor

Bit Byte	7	6	5	4	3	2	1	0
0	(MSB) Feature Code = 0037h (LSB)							
1								
2	Reserved		Version			Persistent	Current	
3	Additional Length = 04h							
4	Reserved							
5	CD-RW media sub-type support (when Disc Type = 1)							
	Subtype7	Subtype6	Subtype5	Subtype4	Subtype3	Subtype2	Subtype1	Subtype0
6	Reserved							
7	Reserved							

The Feature Code field shall be set to 0037h.

The Version field shall be set to 0000b.

The Persistent bit shall be defined as in 5.2.2.3.

The Current bit shall be defined as in 5.2.2.4.

The Additional Length field shall be set to 04h.

CD-RW media is identified in the media lead-in ATIP when Disc Type = 1. The specific CD-RW media type is identified in the Disc sub-type code, a 3 bit value. Byte 5 identifies the sub-types supported by the Drive. If SubtypeX = 0, then the Drive does not support writing SubtypeX. If SubtypeX = 1, then the Drive supports writing SubtypeX. Refer to System Description Rewritable Compact Disc Systems, part III Volume 2: CD-RW for details of the specific media identified by Disc Type and Disc Sub-type codes.

No specific command or mode page support is required by the presence of this feature.

5.3.28 BD-R Pseudo-Overwrite (POW) Feature (0038h)

A Drive that reports the feature is able to provide Logical Block overwrite service on BD-R discs that are formatted as SRM+LOW. The feature descriptor is defined in Table 158.

Table 158 — BD-R Pseudo-OverWrite Feature Descriptor

Bit	7	6	5	4	3	2	1	0
0	(MSB) Feature Code = 0038h (LSB)							
1								
2	Reserved		Version = 0000b			Persistent	Current	
3	Additional Length = 4							
4	Reserved							
5	Reserved							
6	Reserved							
7	Reserved							

The Feature Code field shall be set to 0038h.

The Version field shall be set to 0000b.

The Persistent bit shall be defined as in 5.2.2.3.

The Current bit shall be defined as in 5.2.2.4.

The Additional Length field shall be set to 04h.

When this feature is current, the Drive shall provide Pseudo-overwrite services as described in [UDF]. The physical implementation shall be according to the rules for Pseudo-OverWrite described in [BD-Ref2]. See 4.5.3.5.4, Pseudo-OverWrite (POW) for a description of implementation requirements. This feature shall not be supported on multi-session discs.

5.3.29 DVD+RW Dual Layer Feature (003Ah)

The presence of the DVD+RW DL Feature indicates that the Drive is capable of reading a recorded DVD+RW DL disc that is formatted according to [DVD+Ref4]. Specifically, this includes the capability of reading DCBs. The DVD+RW DL Feature descriptor is shown in Table 159.

Table 159 — DVD+RW DL Feature Descriptor

Bit Byte	7	6	5	4	3	2	1	0
0	(MSB) Feature Code = 003Ah (LSB)							
1								
2	Reserved		Feature Version = 0000b			Persistent	Current	
3	Additional Length = 4							
4	Reserved						Write	
5	Reserved					Quick Start	Close Only	
6	Reserved							
7	Reserved							

The Feature Code field shall be set to 003Ah.

The Version field shall be set to 0000b.

The Persistent bit shall be defined as in 5.2.2.3.

The Current bit shall be defined as in 5.2.2.4.

When Current = 0, either no disc is mounted or the disc currently mounted is not a DVD+RW DL disc. When Current = 1, a disc is mounted and it is a DVD+RW DL disc.

The Additional Length field shall be set to 04h.

This feature may be present only to represent additional capability of the DVD-ROM Profile. If the Write bit is cleared to zero, then no additional capability is claimed. A device may report this feature only when Profile 10h (DVD-ROM) is reported. No additional commands or mode parameters are required.

If the Write bit is set to one, then the Drive is also capable of background formatting DVD+RW DL discs according to [DVD+Ref4] and is capable of writing DVD+RW DL discs that have been formatted according to [DVD+Ref4].

If the Close Only bit is cleared to zero, then the Drive supports both forms of background format stop. If the Close Only bit is set to one, then the Drive supports only the read compatibility stop.

If the Quick Start bit is zero, the FORMAT UNIT command does not support quick start formatting. If the Quick Start bit is set to one, the FORMAT UNIT command supports quick start formatting.

If a Drive reports this feature with the Write bit set to one and the Current bit is set to one, then it shall support the commands shown in Table 160.

Table 160 — Command Support Required by the DVD+RW DL Feature with Write

Op Code	Command Description	Reference
5Bh	CLOSE TRACK/SESSION	6.3
04h	FORMAT UNIT	6.5
BFh	SEND DISC STRUCTURE (Format Field = 05H, 30H)	6.33
2Ah	WRITE (10)	6.43
AAh	WRITE (12)	6.44
2Eh	WRITE AND VERIFY (10)	6.45

5.3.30 The DVD+R Double Layer Feature (003Bh)

The presence of the DVD+R Double Layer Feature indicates that the drive is capable of reading a recorded DVD+R Double Layer disc that is written according to [DVD+Ref3]. The DVD+R Double Layer Feature descriptor is shown in Table 161.

Table 161 — DVD+R Double Layer Feature Descriptor

Bit Byte	7	6	5	4	3	2	1	0
0	(MSB) Feature Code = 003Bh (LSB)							
1								
2	Reserved		Version = 0000b			Persistent	Current	
3	Additional Length							
4	Reserved						Write	
5	Reserved							
6	Reserved							
7	Reserved							

The Feature Code field shall be set to 003Bh.

The Version field shall be set to 0000b.

The Persistent bit shall be defined as in 5.2.2.3.

The Current bit shall be defined as in 5.2.2.4. When Current = 0, either no disc is mounted or the disc currently mounted is not a DVD+R Double Layer disc. When Current = 1, a disc is mounted and it is a DVD+R Double Layer disc. Single Layer DVD+R command operation is not compatible with Double Layer DVD+R command operation. Consequently, when Double Layer DVD+R media is present in a Double Layer DVD+R drive, the Current bit of Feature 2Bh (Single Layer DVD+R Feature) shall be set to zero, and the Current bit of Profile 1Bh (Single Layer DVD+R Profile) shall be set to zero.

The Additional Length field shall be set to 04h.

If Write is zero, then no DVD+R Double Layer write capability is claimed.

If Write is one, then the drive claims the ability to write DVD+R Double Layer.

A device may report this feature only when Profile 10h (DVD-ROM) is reported.

If a drive reports this feature with the Current bit set to one, Table 162 shows commands that shall be supported based upon the setting of the Write bit.

Table 162 — Command Support Required by the DVD+R Double Layer Feature

Op Code	Write Bit	Command Description	Reference
5Bh	1	CLOSE TRACK/SESSION	6.3
28h	-	READ (10)	6.15
AAh	-	READ (12)	6.16
51h	-	READ DISC INFORMATION	6.22
ADh	-	READ DISC STRUCTURE (format field values 20h and FFh are mandatory)	6.23
52h	-	READ TRACK INFORMATION	6.26
53h	1	RESERVE TRACK	6.30
BFh	1	SEND DISC STRUCTURE (format field value 20h)	6.33
54h	1	SEND OPC INFORMATION	6.35
35h	1	SYNCHRONIZE CACHE	6.40
2Ah	1	WRITE (10)	6.43
AAh	1	WRITE (12)	6.44

The DVD+R Double Layer Feature does not require the use of the Write Parameters Mode Page.

Note 8. If the Write Parameters Mode Page is supported for other media types, the drive must accept valid mode selects to the Write Parameters Mode Page. The Host should be aware that the drive will always ignore the Write Parameters Mode Page when the DVD+R Double Layer Feature is current.

5.3.31 BD Read Feature (0040h)

This Feature identifies a Drive that is able to read control structures and user data from the BD disc. The BD Read Feature descriptor response data to be returned to the Host is defined in Table 163.

Table 163 — BD Read Feature Descriptor

Bit Byte	7	6	5	4	3	2	1	0
0	(MSB) Feature Code = 0040h (LSB)							
1								
2	Reserved		Version = 0000b				Persistent	Current
3	Additional Length = 28							
4	Reserved							
5	Reserved							
6	Reserved							
7	Reserved							
Class 0 Bitmap identifying BD-RE Read Support								
8	Version 15	Version 14	Version 13	Version 12	Version 11	Version 10	Version 9	Version 8
9	Version 7	Version 6	Version 5	Version 4	Version 3	Version 2	Version 1	Version 0
Class 1 Bitmap identifying BD-RE Read Support								
10	Version 15	Version 14	Version 13	Version 12	Version 11	Version 10	Version 9	Version 8
11	Version 7	Version 6	Version 5	Version 4	Version 3	Version 2	Version 1	Version 0
Class 2 Bitmap identifying BD-RE Read Support								
12	Version 15	Version 14	Version 13	Version 12	Version 11	Version 10	Version 9	Version 8
13	Version 7	Version 6	Version 5	Version 4	Version 3	Version 2	Version 1	Version 0
Class 3 Bitmap identifying BD-RE Read Support								
14	Version 15	Version 14	Version 13	Version 12	Version 11	Version 10	Version 9	Version 8
15	Version 7	Version 6	Version 5	Version 4	Version 3	Version 2	Version 1	Version 0
16 - 23	Class Bitmaps identifying BD-R Read Support							
24 - 31	Class Bitmaps identifying BD-ROM Read Support							

The Feature Code field shall be set to 0040h.

The Version field shall be set to 0000b.

The Persistent bit shall be defined as in 5.2.2.3.

The Current bit shall be defined as in 5.2.2.4.

The Additional Length field shall be set to 1Ch.

Bytes 8 and 9 contain a bit map of versions of BD-RE media class 0 that this Drive is capable of reading. Bytes 10 and 11 contain a bit map of versions of BD-RE media class 1 that this Drive is capable of reading. Bytes 12 and 13 contain a bit map of versions of BD-RE media class 2 that this Drive is capable of reading. Bytes 14 and 15 contain a bit map of versions of BD-RE media class 3 that this Drive is capable of reading. If the Version K bit (K = 0...15) of the Class M (M = 0...3) bit map is set to zero, the Drive claims no read capabilities for BD-RE

discs of Class M and Version K. If the version K bit is set to one, the Drive is able to read BD-RE discs of class 0 and version K.

Bytes 16 - 23 contain a bit map identifying the class/version of BD-R media that this Drive is capable of reading:

- Bytes 16 and 17 contain a bit map of versions of BD-R media class 0 that this Drive is capable of reading.
- Bytes 18 and 19 contain a bit map of versions of BD-R media class 1 that this Drive is capable of reading.
- Bytes 20 and 21 contain a bit map of versions of BD-R media class 2 that this Drive is capable of reading.
- Bytes 22 and 23 contain a bit map of versions of BD-R media class 3 that this Drive is capable of reading.

The Version bit meanings are as defined for BD-RE media.

Bytes 24 - 31 contain a bit map identifying the class/version of BD-ROM media that this Drive is capable of reading:

- Bytes 24 and 25 contain a bit map of versions of BD-ROM media class 0 that this Drive is capable of reading.
- Bytes 26 and 27 contain a bit map of versions of BD-ROM media class 1 that this Drive is capable of reading.
- Bytes 28 and 29 contain a bit map of versions of BD-ROM media class 2 that this Drive is capable of reading.
- Bytes 30 and 31 contain a bit map of versions of BD-ROM media class 3 that this Drive is capable of reading.

The Version bit meanings are as defined for BD-RE media.

If a Drive reports this feature with the Current bit set to one, then the Drive shall support the commands shown in Table 164.

Table 164 — Command Support Required by the BD Read Feature

Op Code	Command Description	Reference
28h	READ (10)	6.15
A8h	READ (12)	6.16
ADh	READ DISC STRUCTURE (format = 0, 30h, FFh)	6.23
43h	READ TOC/PMA/ATIP (format 0 and 1)	6.25

5.3.32 BD Write Feature (0041h)

This Feature identifies a Drive that is able to write control structures and user data to certain BD discs. The BD Write Feature descriptor response data to be returned to the Host is defined in Table 165.

Table 165 — BD Write Feature Descriptor

Bit	7	6	5	4	3	2	1	0
Byte								
0	(MSB) Feature Code = 0041h (LSB)							
1								
2	Reserved		Version = 0000h				Persistent	Current
3	Additional Length = 20							
4	Reserved							
5	Reserved							
6	Reserved							
7	Reserved							
Class 0 Bitmap identifying BD-RE Write Support								
8	Version 15	Version 14	Version 13	Version 12	Version 11	Version 10	Version 9	Version 8
9	Version 7	Version 6	Version 5	Version 4	Version 3	Version 2	Version 1	Version 0
Class 1 Bitmap identifying BD-RE Write Support								
10	Version 15	Version 14	Version 13	Version 12	Version 11	Version 10	Version 9	Version 8
11	Version 7	Version 6	Version 5	Version 4	Version 3	Version 2	Version 1	Version 0
Class 2 Bitmap identifying BD-RE Write Support								
12	Version 15	Version 14	Version 13	Version 12	Version 11	Version 10	Version 9	Version 8
13	Version 7	Version 6	Version 5	Version 4	Version 3	Version 2	Version 1	Version 0
Class 3 Bitmap identifying BD-RE Write Support								
14	Version 15	Version 14	Version 13	Version 12	Version 11	Version 10	Version 9	Version 8
15	Version 7	Version 6	Version 5	Version 4	Version 3	Version 2	Version 1	Version 0
16 - 23	Class Bitmaps identifying BD-R Write Support							

The Feature Code field shall be set to 0041h.

The Version field shall be set to 0000b.

The Persistent bit shall be defined as in 5.2.2.3.

The Current bit shall be defined as in 5.2.2.4.

.The Additional Length field shall be set to 14h.

Bytes 8 and 9 contain a bit map of versions of BD-RE media class 0 that this Drive is capable of writing. Bytes 10 and 11 contain a bit map of versions of BD-RE media class 1 that this Drive is capable of writing. Bytes 12 and 13 contain a bit map of versions of BD-RE media class 2 that this Drive is capable of writing. Bytes 14 and 15 contain a bit map of versions of BD-RE media class 3 that this Drive is capable of writing. If the Version K bit (K = 0...15) of the Class M (M = 0...3) bit map is set to zero, the Drive claims no write capabilities for BD-RE

discs of Class M and Version K. If the version K bit is set to one, the Drive is able to write BD-RE discs of class 0 and version K.

Bytes 16 - 23 contain a bit map identifying the class/version of BD-R media that this Drive is capable of recording:

- Bytes 16 and 17 contain a bit map of versions of BD-R media class 0 that this Drive is capable of recording.
- Bytes 18 and 19 contain a bit map of versions of BD-R media class 1 that this Drive is capable of recording.
- Bytes 20 and 21 contain a bit map of versions of BD-R media class 2 that this Drive is capable of recording.
- Bytes 22 and 23 contain a bit map of versions of BD-R media class 3 that this Drive is capable of recording.

The Version bit meanings are as defined for BD-RE media.

If a Drive reports this feature with the Current bit set to one, then the Drive shall support the commands shown in Table 166.

Table 166 — Command Support Required by the BD Write Feature

Op Code	Command Description	Reference
04h	FORMAT UNIT	6.5
2Ah	WRITE (10)	6.43

5.3.33 TSR Feature (0042h)

A Drive that reports the TSR (Timely Safe Recording) feature is able to detect and report defective writable units and to manage the defect or not according to instructions from the host. The feature descriptor is defined in Table 167.

Table 167 — TSR Feature Descriptor

Bit	7	6	5	4	3	2	1	0
Byte								
0	(MSB) Feature Code = 0042h							(LSB)
1								
2	Reserved		Version = 0000b			Persistent	Current	
3	Additional Length = 0							

The Feature Code field shall be set to 0042h.

The Version field shall be set to 0000b.

The Persistent bit shall be defined as in 5.2.2.3.

The Current bit shall be defined as in 5.2.2.4.

The Additional Length field shall be set to 00h.

When this feature is present and current, the Drive provides error detection and reporting within selectable threshold, and controllable hardware defect management.

If a Drive reports this feature with the Current bit set to one, then the Drive shall support the commands shown in Table 168.

Table 168 — Command Support Required by the TSR Feature

Op Code	Command Description	Reference
ACh	GET PERFORMANCE (Support for Type = 2 is mandatory)	6.8
35h	SYNCHRONIZE CACHE	6.40
2Ah	WRITE (10)	6.43
AAh	WRITE (12)	6.44

Drives that support this Feature shall implement the mode pages shown in Table 169.

Table 169 — TSR Feature Parameters

Page Code	Mode Page	Reference
01h	Read/Write Error Recovery Parameters Mode Page	7.3

5.3.34 HD DVD Read Feature (0050h)

This Feature identifies a Drive that **is able to** read HD DVD specific information from the media. This Feature indicates support for reading HD DVD specific structures. This Feature is current only if HD DVD specific structures are available for reading.

The Feature descriptor response data to be returned to the Host is defined in Table 170.

Table 170 — HD DVD Read Feature Descriptor

Bit Byte	7	6	5	4	3	2	1	0
0	(MSB) Feature Code = 0050h (LSB)							
1								
2	Reserved		Version = 0000b			Persistent	Current	
3	Additional Length = 04h							
4	Reserved						HD DVD-R	
5	Reserved							
6	Reserved						HD DVD-RW	
7	Reserved							

The Feature Code field shall be set to 0050h.

The Version field shall be set to 0000b.

The Persistent bit shall be defined as in 5.2.2.3.

The Current bit shall be defined as in 5.2.2.4. This bit shall be set to zero if HD DVD medium is not present.

The Additional Length field shall be set to 04h.

The HD DVD-R bit, when set to one, indicates support for reading of HD DVD-R media.

The HD DVD-RAM bit, when set to one, indicates support for reading of HD DVD-RAM media.

If a Drive reports this feature with the Current bit set to one, then the Drive shall support the commands shown in Table 171.

Table 171 — Command Support Required by the HD DVD Read Feature

Op Code	Command Description	Reference
28h	READ (10)	6.15
A8h	READ (12)	6.16
ADh	READ DISC STRUCTURE (Media Type = 0, format = 0, 03h, 04h, 12h, 15h, and FFh)	6.23
43h	READ TOC/PMA/ATIP	6.25

5.3.35 HD DVD Write Feature (0051h)

This Feature indicates the ability to write to HD DVD-R/-RW media.

The Feature descriptor response data to be returned to the Host is defined in Table 172.

Table 172 — HD DVD Write Feature Descriptor

Bit Byte	7	6	5	4	3	2	1	0	
0	(MSB) Feature Code = 0051h (LSB)								
1									
2	Reserved		Version = 0000b			Persistent	Current		
3	Additional Length = 04h								
4	Reserved							HD DVD-R	
5	Reserved								
6	Reserved							HD DVD-RW	
7	Reserved								

The Feature Code field shall be set to 0051h.

The Version field shall be set to 0000b.

The Persistent bit shall be defined as in 5.2.2.3.

The Current bit shall be defined as in 5.2.2.4. This bit shall be set to zero if HD DVD-R/-RW medium is not present.

The Additional Length field shall be set to 04h.

The HD DVD-R bit, when set to one, indicates support for writing of HD DVD-R media.

The HD DVD-RAM bit, when set to one, indicates support for writing of HD DVD-Rewritable media.

If a Drive reports this feature with the Current bit set to one and HD DVD-R set to one, then the Drive shall support the commands shown in Table 173.

Table 173 — Command Support Required by the HD DVD Write Feature for HD DVD-R

Op Code	Command Description	Reference
51h	READ DISC INFORMATION	6.22
52h	READ TRACK INFORMATION	6.26
2Ah	WRITE (10)	6.43
Aah	WRITE (12)	6.44
04h	FORMAT UNIT (Format Type = 16h)	6.5
	RESERVE TRACK	
BFh	SEND DISC STRUCTURE (Media Type = 0, Format = 0Fh)	6.33
54h	SEND OPC INFORMATION (Shall be implemented if OPC Information is returned in the READ DISC INFORMATION returned data.)	6.35

If a Drive reports this feature with the Current bit set to one and HD DVD-RAM set to one, then the Drive shall support the commands shown in Table 174.

Table 174 — Command Support Required by the HD DVD Write Feature for HD DVD-RAM

Op Code	Command Description	Reference
04h	FORMAT UNIT (Format Type = 00h)	6.5
2Ah	WRITE (10)	6.43
AAh	WRITE (12)	6.44
2Eh	WRITE AND VERIFY (10)	6.45

5.3.36 Hybrid Disc Feature (0080h)

This feature is present when the Drive is able to access some Hybrid Discs.

The Feature descriptor response data to be returned to the Host is defined in Table 175.

Table 175 — Hybrid Disc Feature Descriptor

Bit	7	6	5	4	3	2	1	0
Byte								
0	(MSB) Feature Code = 0080h							(LSB)
1								
2	Reserved		Version = 0000b			Persistent	Current	
3	Additional Length = 04h							
4	Reserved						RI	
5	Reserved							
6	Reserved							
7	Reserved							

The Feature Code field shall be set to 0080h.

The Version field shall be set to 0000b.

The Persistent bit shall be defined as in 5.2.2.3.

The Current bit shall be defined as in 5.2.2.4. This bit shall be set to one only when the Drive detects a supported hybrid disc.

The Additional Length field shall be set to 04h.

The Reset Immunity (RI) bit, when set to one, indicates the ability to maintain the online Format-layer through any reset and power-cycle. If the RI bit is set to one, the Drive shall preserve the selection of the Format-layer through power-cycle and reset. If the RI bit is set to zero, the online Format-layers before and after the power-cycle or reset may be different. The Drive may or may not clear the preservation of the online Format-layers at disc ejection. If the Drive supports recording of a writable Format-layer, the RI bit shall be set to one. Otherwise the Drive shall treat the recordable Format-layer as Read-only except the recordable Format-layer is the default Format-layer.

Drives that support this Feature shall implement the commands specified in Table 176.

Table 176 — Hybrid Disc Feature Commands

Op Code	Command Description	Reference
ADh	READ DISC STRUCTURE (Format code 90h shall be supported)	6.23
1Bh	START STOP UNIT (FL and Format-layer Number fields shall be supported)	6.39

5.3.37 Power Management Feature (0100h)

This Feature identifies a Drive that is able to perform Host and Drive directed power management. The Feature descriptor response data to be returned to the Host is defined in Table 177.

Table 177 — Power Management Feature Descriptor Format

Bit Byte	7	6	5	4	3	2	1	0	
0	(MSB) Feature Code = 0100h							(LSB)	
1									
2	Reserved		Version = 0000b				Persistent	Current	
3	Additional Length = 00h								

The Feature Code field shall be set to 0100h.

The Version field shall be set to 0000b.

The Persistent bit shall be defined as in 5.2.2.3.

The Current bit shall be defined as in 5.2.2.4.

The Additional Length field shall be set to zero.

Drives that support this Feature shall implement the commands specified in Table 178.

Table 178 — Power Management Feature Commands

Op Code	Command Description	Reference
4Ah	GET EVENT STATUS NOTIFICATION (Power Management Class events shall be supported)	6.7
1Bh	START STOP UNIT (Power Condition field shall be supported)	6.39

Drives that support this Feature shall implement the the mode parameters specified in Table 179.

Table 179 — Power Management Feature Parameters

Page Code	Page Description	Reference
1Ah	Power Condition mode page	

5.3.38 S.M.A.R.T. Feature (0101h)

This Feature identifies a Drive that is able to perform Self-Monitoring Analysis and Reporting Technology. S.M.A.R.T. was developed to manage the reliability of data storage Drives. S.M.A.R.T.

Peripheral data storage Drives may suffer performance degradation or failure due to a single event or a combination of events. Some events are immediate and catastrophic while others cause a gradual degradation of the Drive's ability to perform. It is possible to predict a portion of the failures, but S.M.A.R.T. is unable to and shall not predict all future Drive failures.

It is the responsibility of a S.M.A.R.T. Drive to predict an impending failure and report that failure via an Informational Exception Condition.

Table 180 — S.M.A.R.T. Feature Descriptor Format

Bit	7	6	5	4	3	2	1	0
Byte								
0	(MSB) Feature Code = 0101h							(LSB)
1								
2	Reserved		Version = 0000b			Persistent	Current	
3	Additional Length = 04h							
4	Reserved						PP	
5	Reserved							
6	Reserved							
7	Reserved							

The Feature Code field shall be set to 0101h.

The Version field shall be set to 0h.

The Persistent bit shall be defined as in 5.2.2.3.

The Current bit shall be defined as in 5.2.2.4.

The Additional Length field shall be set to 04h.

If the Page Present (PP) bit is set to zero, then this Drive claims no support for the Informational Exceptions Control mode page (1Ch).

If the Page Present (PP) bit is set to one, then the this Drive supports the Informational Exceptions Control mode page (1Ch).

If the Fault / Failure Reporting Mode Page is not supported the Drive shall use the following default values:

1. Performance (Perf) bit shall be 0 (Delays are acceptable).
2. Enable Warning (Ewasc) bit shall be 0 (Disable WARNING Sense Code reporting).
3. Disable Exception Control (Dexcept) bit shall be 0 (Do not Disable reporting of exception conditions). Test bit shall be 0.
4. Method of Reporting Informational Exceptions (MRIE) shall be 4 (Unconditionally generate recovered error).
5. Interval Timer shall be set to 6 000.

5.3.39 Embedded Changer Feature (0102h)

This Feature identifies a Drive that is able to move media from a storage area to a mechanism and back. The Feature descriptor response data to be returned to the Host is defined in Table 181.

Table 181 — Embedded Changer Feature Descriptor Format

Bit Byte	7	6	5	4	3	2	1	0
0	(MSB) Feature Code = 0102h (LSB)							
1								
2	Reserved		Version = 0000b			Persistent	Current	
3	Additional Length = 04h							
4	Reserved			SCC	Reserved	SDP	Reserved	
5	Reserved							
6	Reserved							
7	Reserved			Highest Slot Number				

The Feature Code field shall be set to 0102h.

The Version field shall be set to 0000b.

The Persistent bit shall be defined as in 5.2.2.3.

The Current bit shall be defined as in 5.2.2.4.

The Additional Length field shall be set to 4.

The SCC (Side Change Capable) bit, when set to zero, shall indicate that the Drive is not capable of selecting both sides of the media. When set to one, shall indicate that the Drive is capable of selecting both sides of the media.

The SDP (Supports Disc Present) bit, when set to zero, shall indicate that the Drive is unable to report the contents of the slots after a reset or magazine change. When set to one, shall indicate that the Drive is able to report the contents of the slots after a reset or magazine change and that the response to the MECHANISM STATUS command shall contain valid Disc is Present status information for all slots.

Highest Slot Number shall be set to the number of slots minus one.

If this Feature is current, the Removable Medium Feature shall be current. Drives that support an embedded changer shall implement the commands specified in Table 182.

Table 182 — Embedded Changer Feature Command

Op Code	Command Description	Reference
A6h	LOAD/UNLOAD MEDIUM	6.10
BDh	MECHANISM STATUS (If the Drive supports Write Protect Feature (0004h), the Media Cartridge Write Protection status bits (CWP_V, CWP) of the MECHANISM STATUS command shall be supported.)	6.11

5.3.40 Microcode Upgrade Feature (0104h)

This Feature identifies a Drive that is able to upgrade its internal microcode via the interface.

The Feature descriptor response data to be returned to the Host is defined in Table 183.

Table 183 — Microcode Upgrade Feature Descriptor Format

Bit Byte	7	6	5	4	3	2	1	0
0	(MSB) Feature Code = 0104h (LSB)							
1								
2	Reserved		Version = 0001b			Persistent	Current	
3	Additional Length = 04h							
4	Reserved						M5	
5	Reserved							
6	Reserved							
7	Reserved							

The Feature Code field shall be set to 0104h.

The Version field shall be set to 0001b.

The Persistent bit shall be defined as in 5.2.2.3.

The Current bit shall be defined as in 5.2.2.4.

The Additional Length field shall be set to 4.

The M5 bit is used to specify that the Drive supports validating the 5-bit Mode field of the READ BUFFER and WRITE BUFFER commands. If M5 is set to one, the Drive shall validate the Mode field of both the READ BUFFER and WRITE BUFFER commands as a 5-bit field as described in [SPC-3].

Drives that support microcode upgrades shall implement the commands specified in Table 184.

Table 184 — Microcode Upgrade Feature Command

Op Code	Command Description	Reference
3Ch	READ BUFFER with Mode 00011b set	6.17
3Bh	WRITE BUFFER with Mode 00111b (Download microcode with offset and save)	6.46

5.3.41 Timeout Feature (0105h)

This Feature identifies a Drive that is able to always respond to commands within a set time period. If a command is unable to complete normally within the allotted time, it completes with an error.

The Feature descriptor response data to be returned to the Host is defined in Table 185.

Table 185 — Timeout Feature Descriptor Format

Bit Byte	7	6	5	4	3	2	1	0	
0	(MSB) Feature Code = 0105h							(LSB)	
1									
2	Reserved		Version = 0001b			Persistent		Current	
3	Additional Length = 04h								
4	Reserved							Group3	
5	Reserved								
6	(MSB) Unit Length							(LSB)	
7									

The Feature Code field shall be set to 0105h.

The Version field shall be set to 0001b.

The Persistent bit shall be defined as in 5.2.2.3.

The Current bit shall be defined as in 5.2.2.4.

The Additional Length field shall be set to 04h.

The Group3 bit of one indicates that the Drive supports the G3Enable bit and the Group3 Timeout field in Timeout & Protect Mode Page (1Dh). If this bit is set to 1, the Drive shall also support VERIFY (10) command and handling of G3tout bit in VERIFY (10) command. See 11.1.1, "Group 3 timeout for Real Time Stream recording/playback" on page 217. If Real-Time Streaming Feature (0107h) is not supported, this bit shall be set to zero.

The Unit Length field indicates a unit of block length, in sectors, corresponds to increase a unit of Group 3 time unit. When the Group3 bit is set to 0, Unit Length field is not valid.

Drives that support this Feature shall support the parameters listed in Table 186.

Table 186 — Timeout Feature Parameter

Page Code	Parameter	Reference
1Dh	Timeout and Protect Page	7.9

Drives that support queuing shall support Event Notification Class 6. If queuing is not supported, the current command shall be terminated with CHECK CONDITION status and SK/ASC/ASCQ values shall be set to ILLEGAL REQUEST/INSUFFICIENT TIME FOR OPERATION.

Event Notification Class 6 (Device Busy) shall be supported if queuing is supported.

5.3.42 DVD CSS Feature (0106h)

This Feature identifies a Drive that is able to perform DVD CSS/CPM authentication and key management. This Feature identifies Drives that support CSS for DVD-Video and CPPM for DVD-Audio. The Drive shall maintain the integrity of the keys by only using DVD CSS authentication and key management procedures. This Feature shall be current only if a media containing CSS-protected DVD-Video and/or CPPM-protected DVD-Audio content is loaded.

The Feature descriptor response data to be returned to the Host is defined in Table 187.

Table 187 — DVD CSS Feature Descriptor Format

Bit Byte	7	6	5	4	3	2	1	0
0	(MSB) Feature Code 0106h (LSB)							
1								
2	Reserved		Version = 0000b			Persistent	Current	
3	Additional Length = 04h							
4	Reserved							
5	Reserved							
6	Reserved							
7	CSS Version							

The Feature Code field shall be set to 0106h.

The Version field shall be set to 0000b.

The Persistent bit shall be defined as in 5.2.2.3.

The Current bit shall be set to zero if DVD CSS/CPM media is not present. Otherwise, this bit shall be defined as in 5.2.2.4.

The Additional Length field shall be set to 4.

The CSS version shall be set to 01h.

Drives that support this Feature shall implement the commands specified by Table 188.

Table 188 — DVD CSS Feature Commands

Op Code	Command Description	Reference
A4h	REPORT KEY except KEY Format 010001b (The KEY Format 000100b (TITLE KEY) does not succeed for CPPM protected sectors, since they do not contain a Title Key.)	6.28
A3h	SEND KEY	6.34
ADh	READ DISC STRUCTURE with Format Code 02h	6.23

5.3.43 Real Time Streaming Feature (0107h)

This Feature identifies a Drive that is able to perform reading and writing within Host specified (and Drive verified) performance ranges. This Feature also indicates whether the Drive supports the Stream playback operation.

The Feature descriptor response data to be returned to the Host is defined in Table 189.

Table 189 — Real Time Streaming Feature Descriptor Format

Bit	7	6	5	4	3	2	1	0
Byte								
0	(MSB) Feature Code = 0107h							(LSB)
1								
2	Reserved		Version = 0011b			Persistent	Current	
3	Additional Length =04h							
4	Reserved		RBCB	SCS	MP2A	WSPD	SW	
5	Reserved							
6	Reserved							
7	Reserved							

The Feature Code field shall be set to 0107h.

The Version Field shall be set to 0011b.

The Persistent bit shall be defined as in 5.2.2.3.

The Current bit shall be defined as in 5.2.2.4.

The Additional Length field shall be set to 04h.

The Read Buffer Capacity Block (RBCB) bit indicates that the Drive supports the READ BUFFER CAPACITY command and its Block bit.

The Set CD Speed (SCS) bit of one indicates that the Drive supports the SET CD SPEED command. Otherwise, the Drive does not support the SET CD SPEED command.

The Mode Page 2A (MP2A) bit of one indicates that the MM Capabilities & Mechanical Status Mode Page (2Ah) with the Drive Write Speed Performance Descriptor Blocks is supported. Otherwise, the MM Capabilities & Mechanical Status Mode Page (2Ah), with the Drive Write Speed Performance Descriptor Blocks are not supported by the Drive.

Note 9. The MM Capabilities & Mechanical Status Mode Page is a legacy structure. Implementation is not recommended.

A Write Speed Performance Descriptor (WSPD) bit of one indicates that the Drive supports the Write Speed (Type field = 03h) data of GET PERFORMANCE command and the WRC field of SET STREAMING command. This bit shall be set to one, if Drive supports writing speed selection.

A Stream Writing (SW) bit of one indicates that the Drive supports the Stream recording operation. A SW bit of zero indicates that the Drive may not support the Stream recording operation (see 4.8.4)

Drives that support this Feature shall implement the commands listed in Table 190.

Table 190 — Real Time Streaming Feature Commands

Op Code	Command Description	Reference
ACh	GET PERFORMANCE with Type field of 00h, and Type field 01h when SW bit is set to one and Type field of 03h when WSPD bit is set to one	6.8
A8h	READ (12)	6.16
5Ch	READ BUFFER CAPACITY with Block bit of 1 (Shall be implemented when RBCB set to 1)	6.18
A7h	SET READ AHEAD	6.37
B6h	SET STREAMING (WRC field of SET STREAMING command shall be supported when WSPD bit is set to 1.)	6.38
AAh	WRITE (12) with Streaming bit when SW bit is set to one	6.44

5.3.44 Drive Serial Number Feature (0108h)

This Feature identifies a Drive that has a unique serial number. The vendor ID, model ID, and serial number is able to uniquely identify a Drive that has this feature.

The Feature descriptor response data to be returned to the Host is defined in Table 191.

Table 191 — Drive Serial Number Feature Descriptor

Bit	7	6	5	4	3	2	1	0	
Byte									
0	(MSB)							Feature Code = 0108h	(LSB)
1									
2	Reserved		Version = 0000b			Persistent	Current		
3	Additional Length								
4 – n	Serial Number								

The Feature Code field shall be set to 0108h.

The Version Field shall be set to 0000b.

The Persistent bit shall be defined as in 5.2.2.3.

The Current bit shall be defined as in 5.2.2.4.

The Additional Length field shall be set to a multiple of 4.

The Serial Number shall be ASCII graphic codes (i.e., codes 20h – 7Eh). Any unused bytes in the Serial Number shall be padded with spaces (20h). There should not be more than three pad bytes.

5.3.45 Media Serial Number Feature (0109h)

This Feature identifies a Drive that is capable of reading a media serial number of the currently installed media. The Feature descriptor response data to be returned to the Host is defined in Table 192.

Table 192 — Drive Serial Number Feature Descriptor

Bit Byte	7	6	5	4	3	2	1	0
0	(MSB) Feature Code = 0109h (LSB)							
1								
2	Reserved		Version = 0000b			Persistent	Current	
3	Additional Length							

The Feature Code field shall be set to 0109h.

The Version Field shall be set to 0000b.

The Persistent bit shall be defined as in 5.2.2.3.

The Current bit shall be defined as in 5.2.2.4.

The Additional Length field shall be set to 00h.

A Drive reporting this feature shall implement the commands listed in Table 193.

Table 193 — Commands Required by the Media Serial Number Feature

Op Code	Command Description	Reference
ABh/01h	Read Media Serial Number (The SERVICE ACTION IN command (ABh) is a meta-command with Service Action Codes that further define specific commands. The READ MEDIA SERIAL NUMBER command is defined by Service Action Code = 01H.)	[SPC-3]

5.3.46 Disc Control Blocks Feature (010Ah)

This Feature identifies a Drive that is able to read and/or write Disc Control Blocks from or to the media. The Feature descriptor response data to be returned to the Host is defined in Table 194.

Table 194 — Disc Control Blocks Feature Descriptor

Bit Byte	7	6	5	4	3	2	1	0
0	(MSB) Feature Code = 010Ah (LSB)							
1								
2	Reserved		Version = 0000b			Persistent	Current	
3	Additional Length							
4	(MSB) Supported DCB entry 0 (LSB)							
5								
6								
7								
n*4 + 4	(MSB) Supported DCB entry n (LSB)							
n*4 + 5								
n*4 + 6								
n*4 + 7								

The Feature Code field shall be set to 010Ah.

The Version Field shall be set to 0000b.

The Persistent bit shall be defined as in 5.2.2.3.

The Current bit shall be defined as in 5.2.2.4.

The Additional Length field shall be set to $N * 4$, where n is the number of Supported DCB entries. The Supported DCB entry n fields shall each contain the Content Descriptor of a supported DCB. Entries shall be sorted in ascending order.

Drives that support this Feature shall implement the commands listed in Table 195.

Table 195 — Disc Control Blocks Feature Commands

Op Code	Command Description	Reference
ADh	READ DISC STRUCTURE (Format Code 30h shall be supported.)	6.23
BFh	SEND DISC STRUCTURE (If any DCB's are identified as writable, format code = 30h of this command shall be supported.)	6.33

5.3.47 DVD CPRM Feature (010Bh)

This Feature identifies a Drive that is able to perform DVD CPRM and is able to perform CPRM authentication and key management. This Feature shall be current only if a DVD CPRM recordable or rewritable medium is loaded.

The Feature descriptor response data to be returned to the Host is defined in Table 196.

Table 196 — DVD CPRM Feature Descriptor Format

Bit Byte	7	6	5	4	3	2	1	0
0	Feature Code = 010Bh							
1								
2	Reserved		Version = 0000b			Persistent	Current	
3	Additional Length = 04h							
4	Reserved							
5	Reserved							
6	Reserved							
7	CPRM version							

The Feature Code field shall be set to 010Bh.

The Version Field shall be set to 0000b.

The Persistent bit shall be defined as in 5.2.2.3.

The Current bit shall be defined as in 5.2.2.4.

The Additional Length field shall be set 04h.

The CPRM version field shall be set to 01h.

Drives that support this Feature shall implement the commands listed in Table 197.

Table 197 — DVD CPRM Feature Commands

Op Code	Command Description	Reference
A2h	REPORT KEY (Key formats 000001b, 000010b, 010001b, 111111b)	6.28
A3h	SEND KEY (Key formats 000001b, 000011b, 111111b)	6.34
ADh	READ DISC STRUCTURE (Format codes 06h, 07h)	6.23

5.3.48 Firmware Information Feature (010Ch)

This Feature shall indicate that the Drive provides the date and time of the creation of the current firmware revision loaded on the device. The date and time shall be the date and time of creation of the firmware version. The date and time shall be GMT. The date and time shall not change for a given firmware revision. The date and time shall be later on “newer” firmware for a given device. This Feature shall be persistent and current if present. No commands are required for this Feature.

The Feature descriptor response data to be returned to the Host is defined in Table 198.

Table 198 — Firmware Information

Bit Byte	7	6	5	4	3	2	1	0
0	(MSB) Feature Code = 010Ch (LSB)							
1								
2	Reserved		Version = 0000b			Persistent	Current	
3	Additional Length = 10h							
4	(MSB) Century (LSB)							
5								
6	(MSB) Year (LSB)							
7								
8	(MSB) Month (LSB)							
9								
10	(MSB) Day (LSB)							
11								
12	(MSB) Hour (LSB)							
13								
14	(MSB) Minute (LSB)							
15								
16	(MSB) Second (LSB)							
17								
18	(MSB) Century (LSB)							
19								
18	Reserved							
19	Reserved							

The Feature Code field shall be set to 010Ch.

The Version Field shall be set to 0000b.

The Persistent bit shall be set to one.

The Current bit shall be set to one.

The Additional Length field shall be set to 10h.

When the creation year is represented as 4 decimal digits, the Century field shall contain the two high order decimal digits represented as ASCII (e.g. If the creation year is 2013, the Century field shall contain 3230h).

When the creation year is represented as 4 decimal digits, the Year field shall contain the two low order decimal digits represented as ASCII (e.g. If the creation year is 2013, the Year field shall contain 3133h).

The Month field contains the creation month represented as decimal ASCII (e.g. If the creation month is August, the Month field shall contain 3038h).

The Day field contains the creation day represented as decimal ASCII (e.g. If the creation day is August 12, the Day field shall contain 3132h).

The Hour field contains the creation hour represented as decimal ASCII (e.g. If the creation time is 1:20:43 PM, the Hour field shall contain 3133h).

The Minute field contains the creation minute represented as decimal ASCII (e.g. If the creation time is 1:20:43 PM, the Minute field shall contain 3230h).

The Second field contains the creation second represented as decimal ASCII (e.g. If the creation time is 1:20:43 PM, the Seconds field shall contain 3433h).

5.3.49 AACS Feature (010Dh)

This Feature identifies a Drive that supports AACS and **is able to** perform AACS authentication process. This Feature shall be current only if a AACS or AACS capable medium is present.

Table 199 — AACS Feature Descriptor

Bit	7	6	5	4	3	2	1	0
Byte								
0	(MSB) Feature Code = 010Dh							(LSB)
1								
2	Reserved		Version = 0000b			Persistent	Current	
3	Additional Length = 04h							
4	Reserved						BNG	
5	Block Count for Binding Nonce							
6	Reserved				Number of AGIDs			
7	AACS Version							

The Feature Code shall be set to 010Dh.

The Version field shall be set to 0000b.

The Persistent bit shall be defined as in 5.2.2.3.

The Current bit shall be defined as in 5.2.2.4. When the Current bit is set to one, an AACS or AACS capable Disc is present and ready.

The Additional Length field shall be set to 04h.

The BNG bit shall be set to one if the Drive supports generating the Binding Nonce. Otherwise it shall be set to zero.

The Block Count for Binding Nonce field shall specify how many blocks are required to store the Binding Nonce for the media.

The Number of AGIDs field indicates the maximum number of AGIDs that the Drive supports concurrently.

The AACS version field shall be set to 01h.

Drives that support this Feature shall implement the commands specified by Table 200.

Table 200 — AACS Feature Commands

Op Code	Command Description	Reference
A4h	REPORT KEY command, Key Class 02h, KEY Formats 000000b, 000001b, 000010b, 100001b, and 111111b.	6.28
A3h	SEND KEY command, Key Class 02h	6.34
ADh	READ DISC STRUCTURE command with Format Codes 80h, 81h, 82h, and 83h.	6.23

5.3.50 VCPS Feature (0110h)

The VCPS feature specifies that the Drive is able to process disc data structures that are specified in the [VCPS]. The VCPS feature descriptor is shown in Table 201.

Table 201 — The VCPS Feature Descriptor

Bit Byte	7	6	5	4	3	2	1	0
0	(MSB) Feature Code (0110h) (LSB)							
1								
2	Reserved		Version = 0000b			Persistent	Current	
3	Additional Length = 04h							
4	Reserved							
5	Reserved							
6	Reserved							
7	Reserved							

The Feature Code shall be set to 0110h.

The Version field shall be set to 0000b.

The Persistent bit shall be defined as in 5.2.2.3.

The Current bit shall be defined as in 5.2.2.4. When the Current bit is set to one, a Disc is present and ready that is either formatted for VCPS or is capable of being formatted for VCPS.

On DVD+R/+RW discs, bits 5 and 6 of byte 16 of the Physical Format Information found in the lead-in ADIP specify VCPS capability of the disc. Bit 5 is set to zero while bit 6 identifies the presence/absence of VCPS related information in the Extended Format Information. When bit 6 is set to zero, the Extended Format Information does not contain VCPS related information and the Current bit is set to zero. When bit 6 is set to one, the Extended Format Information contains VCPS related information and the Current bit is set to one.

Typically, the Control Data Zone is recorded to include this information. However, the Control Data Zone may be recorded by a recorder that is not VCPS capable. Consequently, the Physical Format Information in the Control Data Zone may not correctly match the ADIP version. A VCPS read-only Drive should determine disc capability by inspecting Buffer Zone 2. In the Physical Format Information of the Control Data Zone on a VCPS DVD+ROM disc, bit 6 is set to zero, while bit 5 identifies the presence/absence of VCPS information in Buffer Zone 2. When bit 5 is set to zero, Buffer Zone 2 does not contain VCPS related information. When bit 5 is set to one, the Buffer Zone 2 contains VCPS related information. If there is an indication that VCPS related information is present, then the Current bit is set to one. Otherwise, the Disc is not VCPS Capable and the Current bit is set to zero.

The Additional Length field shall be set to 04h.

A Drive reporting the VCPS Feature shall support the commands shown in Table 202.

Table 202 — Commands required by the VCPS Feature

Op Code	Command Name	Reference
A4h	REPORT KEY (Key Class = 20h)	6.28
A3h	SEND KEY (Key Class = 20h)	6.34

5.4 Profile Definitions

5.4.1 Overview

Profiles define a base set of functions for Drives. A Drive that specifies a Profile as current shall support all Features required by that Profile, but not all Features may be current. If the Drive is not ready (i.e., a Not Ready response to a TEST UNIT READY command) no Profile shall be current (e.g., a Drive, with unformatted media, may not be able to read or write and the corresponding Features are not current). However, the Profile corresponding to the Drive/media system may be current, (e.g., a DVD-RAM Drive with unformatted media loaded may claim compliance to the DVD-RAM Profile, while a DVD-RAM Drive with no media loaded shall claim no Profile as current.)

Drives may support Features in addition to those required by the Profile. A single device may implement more than one Profile, and more than one Profile may be current at any given time. Table 87 shows the list of profiles defined in this document.

5.4.2 No Current Profile (0000h)

The Feature Header (Table 82) contains the Current Profile field. When no supported profile is current, the Current Profile field shall be zero. Consequently, no profile shall be defined for profile number 0000h.

5.4.3 Non-Removable Disk Profile (0001h)

Drives identifying Profile 0001h as current shall support the Features listed in Table 203.

Table 203 — Mandatory Features for Non-removable Disks

Feature Number	Feature Name	Description
0000h	Profile List	A list of all Profiles supported by the device
0001h	Core	Basic Functionality
0010h	Random Readable, PP=1	Read ability for storage devices with random addressing.
0020h	Random Writable	Write support for randomly addressed writes
0024h	Defect Management	Ability of the Drive/media system to provide an apparently defect-free space
0100h	Power Management	Host and device directed power management
0101h	SMART	Self Monitoring Analysis and Reporting Technology (Failure prediction)

5.4.4 Removable Disk Profile (0002h)

Drives identifying Profile 0002h as current shall support the Features listed in Table 204.

Table 204 — Mandatory Features for Removable Disks

Feature Number	Feature Name	Description
0000h	Profile List	A list of all Profiles supported by the device
0001h	Core	Basic Functionality
0002h	Morphing	The device changes its operational behavior due to external events
0003h	Removable Medium	The medium may be removed from the device
0010h	Random Readable, PP=1	Read ability for storage devices with random addressing.
0020h	Random Writable	Write support for randomly addressed writes
0023h	Formattable	Support for formatting of media
0024h	Defect Management	Ability of the Drive/media system to provide an apparently defect-free space
0100h	Power Management	Host and device directed power management
0105h	Timeout	Ability to respond to all commands within a specific time

5.4.5 Magneto-Optical Erasable Profile (0003h)

Drives identifying Profile 0003h as current shall support the Features listed in Table 205.

Table 205 — Mandatory Features for Magneto-Optical Erasable

Feature Number	Feature Name	Description
0000h	Profile List	A list of all Profiles supported by the device
0001h	Core	Basic Functionality
0002h	Morphing	The device changes its operational behavior due to external events
0003h	Removable Medium	The medium may be removed from the device
0010h	Random Readable, PP = 1	Read ability for storage with random addressing
0020h	Random Writable	Write support for randomly addressed writes
0022h	Sector Erasable	Write support for erasable media and media that require an erase pass before overwrite.
0023h	Formattable	Support for formatting of media
0024h	Defect Management	Ability of the Drive/media system to provide an apparently defect free space.
0100h	Power Management	Host and Drive power management
0105h	Timeout	Ability to response to all commands within a specific time

5.4.6 Optical Write Once Profile (0004h)

Drives identifying Profile 0004h as current shall support the Features listed in Table 206.

Table 206 — Mandatory Features for Optical Write Once

Feature Number	Feature Name	Description
0000h	Profile List	A list of all Profiles supported by the device
0001h	Core	Basic Functionality
0002h	Morphing	The device changes its operational behavior due to external events
0003h	Removable Medium	The medium may be removed from the device
0010h	Random Readable, PP = 1	Read ability for storage with random addressing
0024h	Defect Management	Ability of the Drive/media system to provide an apparently defect free space.
0025h	Write Once	Write support for write-once media that is writable in random order.
0100h	Power Management	Host and Drive power management
0105h	Timeout	Ability to response to all commands within a specific time

5.4.7 AS-MO Profile (0005h)

Drives identifying Profile 0005h shall support the Features listed in Table 207.

Table 207 — Mandatory Features for AS-MO

Feature Number	Feature Name	Description
0000h	Profile List	A list of all Profiles supported by the device
0001h	Core	Basic Functionality
0002h	Morphing	The device changes its operational behavior due to external events
0003h	Removable Medium	The medium may be removed from the device
0010h	Random Readable, PP=1	Read ability for storage devices with random addressing.
0020h	Random Writable	Write support for randomly addressed writes
0023h	Formattable	Support for formatting of media
0024h	Defect Management	Ability of the Drive/media system to provide an apparently defect-free space
0100h	Power Management	Host and device directed power management
0105h	Timeout	Ability to respond to all commands within a specific time
0107h	Real-Time Streaming	Ability to read and write using Host requested performance parameters

5.4.8 Profile 0008h: CD-ROM

Drives identifying Profile 0008h as current shall support the Features listed in Table 208.

Table 208 — Mandatory Features for CD-ROM

Feature Number	Feature Name	Description
0000h	Profile List	A list of all Profiles supported by the device
0001h	Core	Basic Functionality
0002h	Morphing	The device changes its operational behavior due to external events
0003h	Removable Medium	The medium may be removed from the device
0010h	Random Readable, PP=1	Read ability for storage devices with random addressing.
001Eh	CD Read	The ability to read CD specific structures
0100h	Power Management	Host and device directed power management
0105h	Timeout	Ability to respond to all commands within a specific time

5.4.9 CD-R Profile (0009h)

Drives identifying Profile 0009h as current shall support the Features listed in Table 209.

Table 209 — Mandatory Features for CD-R

Feature Number	Feature Name	Description
0000h	Profile List	A list of all Profiles supported by the device
0001h	Core	Basic Functionality
0002h	Morphing	The device changes its operational behavior due to external events
0003h	Removable Medium	The medium may be removed from the device
0010h	Random Readable, PP = 1	Read ability for storage with random addressing
001Eh	CD Read	The ability to read CD specific structures
0021h	Incremental Streaming Writable	Write support of sequential recording
002Dh	CD Track at Once	Ability to write CD with Track at Once recording
0100h	Power Management	Host and Drive power management
0105h	Timeout	Ability to response to all commands within a specific time
0107h	Real-Time Streaming	Ability to read and write using Host requested performance parameters

5.4.10 CD-RW Profile (000Ah)

Drives identifying Profile 000Ah as current shall support the Features listed in Table 210.

Table 210 — Mandatory Features for CD-RW

Feature Number	Feature Name	Description
0000h	Profile List	A list of all Profiles supported by the device
0001h	Core	Basic Functionality
0002h	Morphing	The device changes its operational behavior due to external events
0003h	Removable Medium	The medium may be removed from the device
0010h	Random Readable, PP = 1	Read ability for storage with random addressing
001Dh	Multi-Read	The Drive complies with OSTA Multi-Read
001Eh	CD Read	The ability to read CD specific structure
0021h	Incremental Streaming Writable	Write support of sequential recording
0023h	Formattable	Support for formatting of media
0026h	Restricted Overwrite	Write support for media that shall be written in multiples of logical blocks
002Dh	CD Track at Once	Ability to write CD with Track at Once recording
0100h	Power Management	Host and Drive power management
0105h	Timeout	Ability to response to all commands within a specific time
0107h	Real-Time Streaming	Ability to read and write using Host requested performance parameters

5.4.11 DVD-ROM Profile (0010h)

Drives identifying Profile 0010h as current shall support the Features listed in Table 211.

Table 211 — Mandatory Features for DVD-ROM

Feature Number	Feature Name	Description
0000h	Profile List	A list of all Profiles supported by the device
0001h	Core	Basic Functionality
0002h	Morphing	The device changes its operational behavior due to external events
0003h	Removable Medium	The medium may be removed from the device
0010h	Random Readable, PP=1	Read ability for storage devices with random addressing.
001Fh	DVD Read	The ability to read DVD specific structures
0100h	Power Management	Host and device directed power management
0105h	Timeout	Ability to respond to all commands within a specific time
0107h	Real-Time Streaming	Ability to read using Host requested performance parameters

5.4.12 DVD-R Sequential recording Profile (0011h)

Drives identifying Profile 0011h as current shall support the Features listed in Table 212.

Table 212 — Mandatory Features for DVD-R Sequential recording

Feature Number	Feature Name	Description
0000h	Profile List	A list of all Profiles supported by the device
0001h	Core	Basic Functionality
0002h	Morphing	The device changes its operational behavior due to external events
0003h	Removable Medium	The medium may be removed from the device
0010h	Random Readable, PP = 1	Read ability for storage with random addressing
001Fh	DVD Read	The ability to respond to all commands within a specific time
0021h	Incremental Streaming Writable	Write support for sequential recording
002Fh	DVD-R/-RW Write	Ability to write data in Disc At Once mode
0100h	Power Management	Host and Drive power management
0105h	Timeout	Ability to response to all commands within a specific time
0107h	Real-Time Streaming	Ability to read and write using Host requested performance parameters
0108h	Drive Serial Number	Ability to provide Drive serial number

5.4.13 DVD-RAM Profile (0012h)

Drives identifying Profile 0012h as current shall support the Features listed in Table 213.

Table 213 — Mandatory Features for DVD-RAM

Feature Number	Feature Name	Description
0000h	Profile List	A list of all Profiles supported by the device
0001h	Core	Basic Functionality
0002h	Morphing	The device changes its operational behavior due to external events
0003h	Removable Medium	The medium may be removed from the device
0010h	Random Readable, PP=1	Read ability for storage devices with random addressing.
001Fh	DVD Read	The ability to read DVD specific structures.
0020h	Random Writable	Write support for randomly addressed writes
0023h	Formattable	Support for formatting of media
0024h	Defect Management	Ability of the Drive/media system to provide an apparently defect-free space
0100h	Power Management	Host and device directed power management
0105h	Timeout	Ability to respond to all commands within a specific time
0107h	Real-Time Streaming	Ability to read and write using Host requested performance parameters.

5.4.14 DVD-RW Restricted Overwrite Profile (0013h)

Drives identifying Profile 0013h as current shall support the Features listed in Table 214.

Table 214 — Mandatory Features for DVD-RW Restricted Overwrite

Feature Number	Feature Name	Description
0000h	Profile List	A list of all Profiles supported by the device
0001h	Core	Basic Functionality
0002h	Morphing	The device changes its operational behavior due to external events
0003h	Removable Medium	The medium may be removed from the device
0010h	Random Readable, PP=1	Read ability for storage devices with random addressing.
001Fh	DVD Read	The ability to read DVD specific structures.
0023h	Formattable	Support for formatting of media
002Ch	Rigid Restricted Overwrite	Ability to write DVD-RW specific structure
0100h	Power Management	Host and device directed power management
0105h	Timeout	Ability to respond to all commands within a specific time
0107h	Real-Time Streaming	Ability to read and write using Host requested performance parameters.
0108h	Drive Serial Number	Ability to provide Drive serial number

5.4.15 DVD-RW Sequential Recording Profile (0014h)

Drives identifying Profile 0014h as current shall support the Features listed in Table 215.

Table 215 — Mandatory Features for DVD-RW Sequential recording

Feature Number	Feature Name	Description
0000h	Profile List	A list of all Profiles supported by the device
0001h	Core	Basic Functionality
0002h	Morphing	The device changes its operational behavior due to external events
0003h	Removable Medium	The medium may be removed from the device
0010h	Random Readable, PP = 1	Read ability for storage with random addressing
001Fh	DVD Read	The ability to respond to all commands within a specific time
0021h	Incremental Streaming Writable	Write support for sequential recording
002Fh	DVD-R/-RW Write	Ability to write data in Disc At Once mode
0100h	Power Management	Host and Drive power management
0105h	Timeout	Ability to response to all commands within a specific time
0107h	Real-Time Streaming	Ability to read and write using Host requested performance parameters
0108h	Drive Serial Number	Ability to provide Drive serial number

5.4.16 DVD-RW Dual Layer Sequential Recording Profile (0015h)

Drives identifying Profile 0015h as current shall support the Features listed in Table 216.

Table 216 — Mandatory Features for DVD-RW Dual Layer Sequential recording

Feature Number	Feature Name	Description
0000h	Profile List	A list of all Profiles supported by the device
0001h	Core	Basic Functionality
0002h	Morphing	The device changes its operational behavior due to external events
0003h	Removable Medium	The medium may be removed from the device
0010h	Random Readable, PP = 1	Read ability for storage with random addressing
001Fh	DVD Read	The ability to respond to all commands within a specific time
0021h	Incremental Streaming Writable	Write support for sequential recording
002Fh	DVD-R/-RW Write	Ability to write data in Disc At Once mode
0100h	Power Management	Host and Drive power management
0105h	Timeout	Ability to response to all commands within a specific time
0107h	Real-Time Streaming	Ability to read and write using Host requested performance parameters
0108h	Drive Serial Number	Ability to provide Drive serial number

5.4.17 DVD-RW Dual Layer Jump Recording Profile (0016h)

Drives identifying Profile 0016h as current shall support the Features listed in Table 217.

Table 217 — Mandatory Features for DVD-RW Dual Layer Jump recording

Feature Number	Feature Name	Description
0000h	Profile List	A list of all Profiles supported by the device
0001h	Core	Basic Functionality
0002h	Morphing	The device changes its operational behavior due to external events
0003h	Removable Medium	The medium may be removed from the device
0010h	Random Readable, PP = 1	Read ability for storage with random addressing
001Fh	DVD Read	The ability to respond to all commands within a specific time
0021h	Incremental Streaming Writable	Write support for sequential recording
0033h	Layer Jump Recording	Write support for Layer Jump recording
0100h	Power Management	Host and Drive power management
0105h	Timeout	Ability to response to all commands within a specific time
0107h	Real-Time Streaming	Ability to read and write using Host requested performance parameters
0108h	Drive Serial Number	Ability to provide Drive serial number

5.4.18 DVD+RW Profile (001Ah)

Drives identifying Profile 001Ah as current shall support the features listed in Table 218.

Table 218 — Mandatory Features for DVD+RW

Feature Number	Feature Name	Description
0000h	Profile List	A list of all Profiles supported by the device
0001h	Core	Mandatory behavior for all devices
0002h	Morphing	The device changes its operational behavior due to external events
0003h	Removable Medium	The medium may be removed from the device
0010h	Random Readable, PP=1	Read ability for storage devices with random addressing
001Fh	DVD Read	The ability to read DVD specific structures
0020h	Random Writable ¹	Write support for randomly addressed writes
0023h	Formattable ¹	Support for formatting of media
002Ah	DVD+RW	Support for reading and optionally writing DVD+RW Media
0100h	Power Management	Host and device directed power management
0105h	Timeout	Ability to respond to all commands within a specific time
0107h	Real-time Streaming	Ability to read and write using Host requested performance parameters
010Ah	DCBs	The ability to read and optionally write DCBs.
¹ This feature is mandatory only when the Write bit of the DVD+RW Feature is set to one.		

5.4.19 DVD+R Profile (001Bh)

Drives identifying Profile 001B as current shall support the features listed in Table 219.

Table 219 — Mandatory Features for DVD+R

Feature Number	Feature Name	Description
0000h	Profile List	A list of all Profiles supported by the device
0001h	Core	Mandatory behavior for all devices
0002h	Morphing	The device changes its operational behavior due to external events
0003h	Removable Medium	The medium may be removed from the device
0010h	Random Readable, PP=1	Read ability for storage devices with random addressing
001Fh	DVD Read	The ability to read DVD specific structures
002Bh	DVD+R	Support for reading and optionally writing DVD+R Media and formats
0100h	Power Management	Host and device directed power management
0105h	Timeout	Ability to respond to all commands within a specific time
0107h	Real-time Streaming	Ability to read and write using Host requested performance parameters
010Ah	DCBs	The ability to read and optionally write DCBs.

5.4.20 DVD+RW Dual Layer Profile (002Ah)

Drives identifying Profile 002Ah as current shall support the features listed in Table 220.

Table 220 — Mandatory Features for DVD+RW

Feature Number	Feature Name	Description
0000h	Profile List	A list of all Profiles supported by the device
0001h	Core	Mandatory behavior for all devices
0002h	Morphing	Device changes operational behavior due to events external to the Host
0003h	Removable Medium	The medium may be removed from the device
0010h	Random Readable, PP=1	Read ability for storage devices with random addressing
001Fh	DVD Read	The ability to read DVD specific structures
0020h	Random Writable	Write support for randomly addressed writes ¹
0023h	Formattable	Support for formatting of media ¹
002Ah	DVD+RW	Support for reading and optionally writing SL DVD+RW Basic Format
003Ah	DVD+RW DL	Support for reading and optionally writing DVD+RW DL Basic Format
0100h	Power Management	Host and device directed power management
0105h	Time-Out	Ability to respond to all commands within a specific time
0107h	Real-time Streaming	Ability to read and write using Host requested performance parameters
010Ah	Disc Control Blocks	The ability to read and optionally write DCBs.
¹ Current only when the Write bit in the DVD+RW Feature Descriptor is set to 1.		

The presence of the DVD+RW DL Profile indicates that the Drive is capable of reading a DVD+RW DL disc that has been formatted and recorded according to [DVD+Ref4]. In addition, the presence of the DVD+RW DL Profile indicates that the WRITE bit in the DVD+RW DL feature is set to one.

5.4.21 DVD+R Double Layer Profile (002Bh)

Drives identifying Profile 002B as current shall support the features listed in Table 221.

Table 221 — Mandatory Features for DVD+R

Feature Number	Feature Name	Description
0000h	Profile List	A list of all Profiles supported by the device
0001h	Core	Mandatory behavior for all devices
0002h	Morphing	The device changes its operational behavior due to external events
0003h	Removable Medium	The medium may be removed from the device
0010h	Random Readable, PP=1	Read ability for storage devices with random addressing
001Fh	DVD Read	The ability to read DVD specific structures
003Bh	DVD+R Double Layer	Support for reading and optionally writing DVD+R Double Layer Media and formats
0100h	Power Management	Host and device directed power management
0105h	Timeout	Ability to respond to all commands within a specific time
0107h	Real-time Streaming	Ability to read and write using Host requested performance parameters
010Ah	DCBs	The ability to read and optionally write DCBs.

5.4.22 BD-ROM Profile (0040h)

Drives identifying Profile 0040h as current shall support the features listed in Table 222.

Table 222 — Mandatory Features for BD-ROM

Feature Number	Feature Name	Description
0000h	Profile List	A list of all Profiles supported by the device
0001h	Core	Mandatory behavior for all devices
0002h	Morphing	Device changes operational behavior upon events external to the Host
0003h	Removable Medium	The medium may be removed from the device
0010h	Random Readable ¹	Read ability for storage devices with random addressing
0040h	BD Read	The ability to read BD specific structures
0100h	Power Management	Host and device directed power management
0105h	Timeout	Ability to respond to all commands within a specific time
0107h	Real-time Streaming	Ability to read (and optionally write) using Host requested performance parameters.

¹PP bit in Random Readable Feature shall be set to 1.

5.4.23 BD-R Sequential Recording (SRM) Profile (0041h)

Drives identifying Profile 0041h as current shall support the features listed in Table 223.

Table 223 — Features For BD-R SRM Profile

Feature Number	Feature Name	Description
0000h	Profile List	A list of all Profiles supported by the device
0001h	Core	Mandatory behavior for all devices
0002h	Morphing	Device changes operational behavior upon events external to the Host
0003h	Removable Medium	The medium may be removed from the device
0010h	Random Readable ¹	Read ability for storage devices with random addressing
0021h	Incremental Streaming Writable	Write support for sequential recording
0023h	Formattable	Support for formatting of media
0024h	Defect Management ²	The Drive/media system is able to provide an apparently defect-free LBA space
0038h	BD-R POW ³	The ability to permit logical overwrites from the user data area of the disc
0040h	BD Read ⁴	The ability to read BD specific structures
0041h	BD Write	The ability to write BD user data areas and certain BD specific structures
0100h	Power Management	Host and device directed power management
0105h	Timeout	Ability to respond to all commands within a specific time
0107h	Real-time Streaming	Ability to read (and optionally write) using Host requested performance parameters.
¹ PP bit in Random Readable Feature shall be set to 1. ² Defect Management Feature shall be marked not Current when no spares are allocated. ³ If both the BD-R SRM profile and the BD-R POW feature are current, then the basic characteristics of sequential recording are maintained, but limited Pseudo-Overwrite is permitted. Such a disc is SRM+POW. ⁴ BD Read Feature shall be marked not Current when media is physically blank.		

5.4.24 BD-R Random Recording (RRM) Profile (0042h)

Drives identifying Profile 0042h as current shall support the features listed in Table 224.

Table 224 — Features For BD-R RRM Profile

Feature Number	Feature Name	Description
0000h	Profile List	A list of all Profiles supported by the device
0001h	Core	Mandatory behavior for all devices
0002h	Morphing	Device changes operational behavior upon events external to the Host
0003h	Removable Medium	The medium may be removed from the device
0010h	Random Readable ¹	Read ability for storage devices with random addressing
0023h	Formattable	Support for formatting of media
0024h	Defect Management ²	The Drive/media system is able to provide an apparently defect-free LBA space
0025h	Write-once	Write support for write-once media that is writable in random order
0040h	BD Read ³	The ability to read BD user data areas and certain BD specific structures
0041h	BD Write	The ability to write BD user data areas and certain BD specific structures
0100h	Power Management	Host and device directed power management
0105h	Timeout	Ability to respond to all commands within a specific time
0107h	Real-time Streaming	Ability to read (and optionally write) using Host requested performance parameters.
¹ PP bit in Random Readable Feature shall be set to 1. ² Defect Management Feature shall be marked not Current when no spares are allocated. ³ BD Read Feature shall be marked not Current when media is physically blank.		

5.4.25 BD-RE Profile (0043h)

Drives identifying Profile 0043h as current shall support the features listed in Table 225.

Table 225 — Mandatory Features for BD-RE

Feature Number	Feature Name	Description
0000h	Profile List	A list of all Profiles supported by the device
0001h	Core	Mandatory behavior for all devices
0002h	Morphing	Device changes operational behavior upon events external to the Host
0003h	Removable Medium	The medium may be removed from the device
0010h	Random Readable ¹	Read ability for storage devices with random addressing
0020h	Random Writable	Write support for randomly addressed writes
0023h	Formattable	Support for formatting of media
0024h	Defect Management ²	The Drive/media system is able to provide an apparently defect-free LBA space
0040h	BD Read ³	The ability to read BD specific structures
0100h	Power Management	Host and device directed power management
0105h	Timeout	Ability to respond to all commands within a specific time
0107h	Real-time Streaming	Ability to read (and optionally write) using Host requested performance parameters.
¹ PP bit in Random Readable Feature shall be set to 1. ² Defect Management Feature shall be marked not Current when no spares are allocated. ³ BD Read Feature shall be marked not Current when media is physically blank.		

5.4.26 HD DVD-ROM Profile (0050h)

Drives identifying Profile 0050h as current shall support the features listed Table 226.

Table 226 — Mandatory Features for HD DVD-ROM

Feature Number	Feature Name	Description
0000h	Profile List	A list of all Profiles supported by the device
0001h	Core	Mandatory behavior for all devices
0002h	Morphing	Device changes operational behavior upon events external to the Host
0003h	Removable Medium	The medium may be removed from the device
0010h	Random Readable ¹	Read ability for storage devices with random addressing
0050h	HD DVD Read	The ability to read HD DVD specific structures
0100h	Power Management	Host and device directed power management
0105h	Timeout	Ability to respond to all commands within a specific time
0107h	Real-time Streaming	Ability to read (and optionally write) using Host requested performance parameters.

¹PP bit in Random Readable Feature shall be set to 1.

5.4.27 HD DVD-R Profile (0051h)

Drives identifying Profile 0051h as current shall support the Features listed in Table 227.

Table 227 — Mandatory Features for HD DVD-R

Feature Number	Feature Name	Description
0000h	Profile List	A list of all Profiles supported by the device
0001h	Core	Basic Functionality
0002h	Morphing	The device changes its operational behavior due to external events
0003h	Removable Medium	The medium may be removed from the device
0010h	Random Readable, PP = 1	Read ability for storage with random addressing
0021h	Incremental Streaming Writable	Write support for sequential recording
0050h	HD DVD Read	The ability to respond to all commands within a specific time
0051h	HD DVD Write	Ability to write HD DVD specific structures
0100h	Power Management	Host and Drive power management
0105h	Timeout	Ability to response to all commands within a specific time
0107h	Real-Time Streaming	Ability to read and write using Host requested performance parameters
0108h	Drive Serial Number	Ability to provide Drive serial number

5.4.28 HD DVD-RAM Profile (0052h)

Drives identifying Profile 0052h as current shall support the Features listed in Table 227.

Table 228 — Mandatory Features for HD DVD-RAM

Feature Number	Feature Name	Description
0000h	Profile List	A list of all Profiles supported by the device
0001h	Core	Basic Functionality
0002h	Morphing	The device changes its operational behavior due to external events
0003h	Removable Medium	The medium may be removed from the device
0010h	Random Readable, PP=1	Read ability for storage devices with random addressing.
0020h	Random Writable	Write support for randomly addressed writes
0023h	Formattable	Support for formatting of media
0024h	Defect Management	Ability of the Drive/media system to provide an apparently defect-free space
0050h	HD DVD Read	The ability to read HD DVD specific structures.
0051h	HD DVD Write	Ability to write HD DVD specific structures
0100h	Power Management	Host and device directed power management
0105h	Timeout	Ability to respond to all commands within a specific time
0107h	Real-Time Streaming	Ability to read and write using Host requested performance parameters.

5.4.29 Profile FFFFh: Drives Not Conforming to a Standard Profile

Profile FFFFh is reported for media that has no defined profile.

Drives identifying Profile FFFFh as current shall support the Features listed in Table 229.

Table 229 — Mandatory Features for Drives Not Conforming to a Standard Profile

Feature Number	Feature Name	Description
0000h	Profile List	A list of all Profiles supported by the device
0001h	Core	Basic Functionality

6 Commands

6.1 Overview

The commands described in this clause are defined uniquely for Multi-Media Drives or have a unique behavior when performed by a Multi-Media Drive.

Certain commands or command options that were present in earlier versions of this standard have been defined as Legacy and are no longer recommended for use in Multi-Media devices and are not described in this clause. Those commands and command options are described in Annex E.

Some commands that may be implemented by MM Drives are not described in this standard, but are found in other SCSI standards. For a complete list of these commands refer to [SPC-3].

The commands described in this clause are listed in Table 230 and Table 231.

Table 230 — Commands for Multi-Media Drives in Alphabetic order

Command Name	Op Code	Reference
BLANK	A1h	6.2
CLOSE TRACK/SESSION	5Bh	6.3
ERASE (10)	2Ch	6.4
FORMAT UNIT	04h	6.5
GET CONFIGURATION	46h	6.6
GET EVENT STATUS NOTIFICATION	4Ah	6.7
GET PERFORMANCE	ACh	6.8
INQUIRY	12h	6.9
LOAD/UNLOAD MEDIUM	A6h	6.10
MECHANISM STATUS	BDh	6.11
MODE SELECT (10)	55h	6.12
MODE SENSE (10)	5Ah	6.13
PREVENT ALLOW MEDIUM REMOVAL	1Eh	6.14
READ (10)	28h	6.15
READ (12)	A8h	6.16
READ BUFFER	3Ch	6.17
READ BUFFER CAPACITY	5Ch	6.18
READ CAPACITY	25h	6.19
READ CD	BEh	6.20
READ CD MSF	B9h	6.21
READ DISC INFORMATION	51h	6.22
READ DISC STRUCTURE	ADh	6.23
READ FORMAT CAPACITIES	23h	6.24
READ TOC/PMA/ATIP	43h	6.25
READ TRACK INFORMATION	52h	6.26
REPAIR TRACK	58h	6.27

Table 230 — Commands for Multi-Media Drives in Alphabetic order (Continued)

Command Name	Op Code	Reference
REPORT KEY	A4h	6.28
REQUEST SENSE	03h	6.29
RESERVE TRACK	53h	6.30
SEEK (10)	2Bh	6.31
SEND CUE SHEET	5Dh	6.32
SEND DISC STRUCTURE	BFh	6.33
SEND KEY	A3h	6.34
SEND OPC INFORMATION	54h	6.35
SET CD SPEED	BBh	6.36
SET READ AHEAD	A7h	6.37
SET STREAMING	B6h	6.38
START STOP UNIT	1Bh	6.39
SYNCHRONIZE CACHE	35h	6.40
TEST UNIT READY	00h	6.41
VERIFY (10)	2Fh	6.42
WRITE (10)	2Ah	6.43
WRITE (12)	AAh	6.44
WRITE AND VERIFY (10)	2Eh	6.45
WRITE BUFFER	3Bh	6.46

Table 231 — Commands for Multi-Media Drives in Operation code order

Command Name	Op Code	Reference
TEST UNIT READY	00h	6.41
REQUEST SENSE	03h	6.29
FORMAT UNIT	04h	6.5
INQUIRY	12h	6.9
START STOP UNIT	1Bh	6.39
PREVENT ALLOW MEDIUM REMOVAL	1Eh	6.14
READ FORMAT CAPACITIES	23h	6.24
READ CAPACITY	25h	6.19
READ (10)	28h	6.15
WRITE (10)	2Ah	6.43
SEEK (10)	2Bh	6.31
ERASE (10)	2Ch	6.4
WRITE AND VERIFY (10)	2Eh	6.45
VERIFY (10)	2Fh	6.42

Table 231 — Commands for Multi-Media Drives in Operation code order (Continue)

Command Name	Op Code	Reference
SYNCHRONIZE CACHE	35h	6.40
WRITE BUFFER	3Bh	6.46
READ BUFFER	3Ch	6.17
READ TOC/PMA/ATIP	43h	6.25
GET CONFIGURATION	46h	6.6
GET EVENT STATUS NOTIFICATION	4Ah	6.7
READ DISC INFORMATION	51h	6.22
READ TRACK INFORMATION	52h	6.26
RESERVE TRACK	53h	6.30
SEND OPC INFORMATION	54h	6.35
MODE SELECT (10)	55h	6.12
REPAIR TRACK	58h	6.27
MODE SENSE (10)	5Ah	6.13
CLOSE TRACK/SESSION	5Bh	6.3
READ BUFFER CAPACITY	5Ch	6.18
SEND CUE SHEET	5Dh	6.32
BLANK	A1h	6.2
SEND KEY	A3h	6.34
REPORT KEY	A4h	6.28
LOAD/UNLOAD MEDIUM	A6h	6.10
SET READ AHEAD	A7h	6.37
READ (12)	A8h	6.16
WRITE (12)	AAh	6.44
GET PERFORMANCE	ACh	6.8
READ DISC STRUCTURE	ADh	6.23
SET STREAMING	B6h	6.38
READ CD MSF	B9h	6.21
SET CD SPEED	BBh	6.36
MECHANISM STATUS	BDh	6.11
READ CD	BEh	6.20
SEND DISC STRUCTURE	BFh	6.33

6.2 BLANK Command

6.2.1 Introduction

ReWritable media that reports either the Restricted Overwrite Feature or the Rigid Restricted Overwrite Feature carries the restriction that it shall be recorded in a sequential way. When those features are present, it becomes necessary to provide a re-initialization of the media to the blank state. The blanking action performed may be either Logical or physical. e.g., CD-RW data is overwritten with Mode 0 data, while the blanking action performed on DVD-RW is a physical erase. The BLANK command provides this capability. Features that specify the use of the BLANK command are listed in Table 232.

Table 232 — Features Associated with the BLANK Command

Feature Number	Feature Name	Command Requirement ¹
0021h	Incremental Streaming Writable	Mandatory for CD-RW and DVD-RW
002Ch	Rigid Restricted Overwrite	Mandatory for DVD-RW
002Dh	CD Track At Once	Mandatory for CD-RW
002Fh	DVD-R/-RW Write	Mandatory for DVD-RW

¹The command requirement is valid only when the feature is current.

6.2.2 The CDB and its Parameters

6.2.2.1 The CDB

The BLANK CDB is shown in Table 233.

Table 233 — BLANK CDB

Bit Byte	7	6	5	4	3	2	1	0
0	Operation Code (A1h)							
1	Reserved			IMMED	Reserved	Blanking Type		
2	(MSB)							
3	Start Address/Logical Track Number							
4								
5							(LSB)	
6	Reserved							
7	Reserved							
8	Reserved							
9	Reserved							
10	Reserved							
11	Control							

6.2.2.2 IMMED

If IMMED is zero, then the requested operation is processed to completion prior to returning status. If IMMED is one, then status is returned once the operation has begun.

6.2.2.3 Blanking Type

Blanking Type identifies the method and coverage of blanking. Blanking Type codes for CD-RW are defined in Table 234 and Blanking Type codes for DVD-RW are defined in Table 235.

6.2.2.4 Start Address/Track Number

Start Address/Track Number meanings are defined within the specific Blanking Type cases shown in Table 234 and Table 235.

Table 234 — Blanking Types CD-RW

Value	Name	Description
000b	Blank the disc	The entire disc is to be blanked. The Start Address parameter is ignored. This is used for clearing the entire disc. The PCA may be excluded. At completion of the operation, the entire PMA, the area from the start time of the lead-in through the last possible start time of lead-out plus 6 750 blocks.
001b	Minimally blank the disc	Blanks only the PMA, disc lead-in and the pre-gap of the first track. The Start Address parameter is ignored. This is used for blanking a disc quickly. After completion of this command the disc is treated as a blank disc. Caution should be exercised when using this command since the program area may still contain user data.
010b	Blank a Track	Blanks the track specified in the Start Address/Track Number field. This command blanks the track only, it does not blank the TOC or the PMA. The track to be blanked shall be in the incomplete session. If the Start Address/Track Number does not reference a track in the incomplete session, then this command shall be terminated with CHECK CONDITION status and SK/ASC/ASCQ values shall be set to ILLEGAL REQUEST/INVALID FIELD IN CDB.
011b	Un-reserve a Track	All data for the last track in the incomplete session shall be blanked. If the track has a PMA entry, the PMA entry shall be blanked. If the disc is blank, the command shall be terminated with GOOD status. The Start Address/Track Number parameter is ignored.
100b	Blank a Track Tail	This blank type is valid only for packet tracks within the incomplete session. If Start Address/Track Number specifies a valid LBA within a track and the LBA is the first sector of a packet, then the area between the LBA and the end of the track that shall be blanked. If the LBA does not exist in any track within the incomplete session, or if the LBA is not the first sector of a packet, then the command shall be terminated with CHECK CONDITION status and SK/ASC/ASCQ values shall be set to ILLEGAL REQUEST/LOGICAL BLOCK ADDRESS OUT OF RANGE. If the track is not a packet track, then this command shall be terminated with CHECK CONDITION status and SK/ASC/ASCQ values shall be set to ILLEGAL REQUEST/INVALID FIELD IN CDB.
101b	Unclose the last complete session	If the disc is blank or the last session is not empty and not closed, then this command shall be terminated with GOOD status. If the last session is empty or if the disc is finalized, the Lead-in and Lead-out of the last complete session shall be blanked.
110b	Blank the last non-empty Session	If the last session is empty, then the Lead-in, program area, and Lead-out of the last complete session shall be blanked. If the last session is incomplete, its program area shall be blanked. Each PMA item for each track in the newly blanked session shall be blanked. If the disc is blank, the command shall be terminated with GOOD status.
111b	Reserved	

Table 235 — Blanking Types for DVD-RW media

Value	Name	Description
000b	Blank the disc	The entire disc is to be blanked. The area from the RMA through the end of Last address of data area plus 3 ECC blocks into the lead-out area shall be blanked. The RMA Lead-in and six RMD blocks at the beginning of RMA shall not be blanked. The Start Address or Track Number parameter is ignored. If a disc is to be blanked that is already fully blanked, no error shall be reported.
001b	Minimally blank the disc	This operation is used for blanking a disc quickly. The Lead-in and the RMA shall be blanked. The RMA Lead-in and six RMD blocks at the beginning of RMA shall not be blanked. The Start Address or Track Number parameter is ignored. Caution should be exercised when using this command since the data area still contains user data. If a disc is to be blanked that is already fully/minimally blanked, no error shall be reported.
010b	Reserved	
011b	Un-reserve a Track	This operation is valid only when the last session has the incomplete state. If the last track is invisible, the track that immediately precedes the invisible track and its RMD entry are blanked. If the last track is incomplete, the incomplete track is blanked. The Start Address or Track Number parameter is ignored.
100b	Blank a Track Tail	This blanking type is valid for only a incrementally recorded track. The track to be blanked shall be in an incomplete session. Blank the area between the LBA specified in Start Address or Track Number field and the end of the track that includes the LBA specified. When the track that is to be blanked is complete track and if the next track is recorded, the last ECC block of the complete track shall be retained as BSGA to guarantee next track readable. If attempting to blank a track that causes generation of fourth NWA, the command shall be terminated with CHECK CONDITION status and SK/ASC/ASCQ shall be set to ILLEGAL REQUEST/NO MORE TRACK RESERVATIONS ALLOWED. The LBA specified shall be the first user data block of an ECC block and shall be an existing linking block of a track. If the start address sector is not a linking block, the command shall be terminated with CHECK CONDITION status and SK/ASC/ASCQ shall be set to ILLEGAL REQUEST/INVALID ADDRESS FOR WRITE.
101b	Unclose the last complete session	This blanking type is valid for only a incrementally recorded track. If the disc is blank or the last session is not empty and not closed, then this command shall be terminated with GOOD status. If the last session is empty or if the disc is finalized, the Lead-in and Lead-out of the last complete session shall be blanked.
110b	Blank Session	If the last session is complete, its Lead-in/Border-in through the end of the Lead-out/Border-out shall be blanked. If the last session is incomplete state, all track(s) in the incomplete session shall be blanked. If the last session is empty state, the complete session immediately preceding the empty session shall be blanked. If the disc is blank, the command shall be terminated with GOOD status.
111b	Reserved	

6.2.3 Command Processing

If the Drive is unable to write to the currently mounted medium, error reporting should follow the guidelines according to 4.1.6.3.

During a Blanking operation that began with the CDB IMMED bit set to one, the Drive shall respond to commands as follows:

1. In response to all commands except REQUEST SENSE, INQUIRY, GET CONFIGURATION, GET EVENT STATUS NOTIFICATION, and TEST UNIT READY, the Drive shall return CHECK CONDITION status and set SK/ASC/ASCQ to NOT READY/LOGICAL UNIT NOT READY/OPERATION IN PROGRESS.
2. In response to the TEST UNIT READY command, the Drive should return CHECK CONDITION status and set SK/ASC/ASCQ to NOT READY/LOGICAL UNIT NOT READY/OPERATION IN PROGRESS. Some legacy implementations allowed for a GOOD status response to a TEST UNIT READY command. This behavior is not recommended.
3. In response to the INQUIRY, GET CONFIGURATION, GET EVENT STATUS NOTIFICATION commands, the Drive shall respond as commanded.
4. In response to the REQUEST SENSE command, unless an error has occurred, the Drive shall return a SK/ASC/ASCQ values set to NOT READY/LOGICAL UNIT NOT READY/OPERATION IN PROGRESS, with the sense key specific bytes set for progress indication.

If the Drive changes to a not ready state during execution, an Operational Change Event shall be generated. When execution is completed and the state returns to ready, an Operational Change Event shall be generated. If the blanking results in one or more features changing currency, an additional Operational Change Event shall be generated.

Ready polling should be done by repetitively issuing the READ DISC INFORMATION command.

6.2.4 Timeouts

The BLANK command belongs to timeout group 2 when IMMED is zero. The group 2 timeout value is only for Host information. The Drive shall not time group 2 timeout commands. Execution shall continue until completion. When the IMMED is set to one, status shall be returned within a Group 1 timeout.

6.2.5 Error Reporting

When the command operation began with the CDB IMMED bit set to one, it is possible that a deferred error may be reported in some future command.

Recommended error reporting is defined in Table 236.

Table 236 — Recommended errors for BLANK Command

Error	Reference	May be Deferred
Unit Attention conditions	Table F.1	
CDB or parameter list validation errors	Table F.2	
Readiness errors	Table F.3	
General media access errors	Table F.5	√
Write errors	Table F.7	√
Hardware failures	Table F.8	√

6.3 CLOSE TRACK/SESSION Command

6.3.1 Introduction

The CLOSE TRACK/SESSION command allows closure of either a track or a session. The features associated with this command are shown in Table 237.

Table 237 — Features Associated with the CLOSE TRACK/SESSION command

Feature Number	Feature Name	Command Requirement ¹
0021h	Incremental Streaming Writable	Mandatory
0028h	MRW	Mandatory (when Write bit is one)
002Ah	DVD+RW	Mandatory (when Write bit is one)
002Bh	DVD+R	Mandatory (when Write bit is one)
002Dh	CD Track At Once	Mandatory
003Ah	DVD+RW Dual Layer	Mandatory
003Bh	DVD+R Double Layer	Mandatory

¹The command requirement is valid only when the feature is current.

6.3.2 The CDB and its Parameters

6.3.2.1 The CDB

The CLOSE TRACK/SESSION CDB is shown in Table 238.

Table 238 — CLOSE TRACK/SESSION CDB

Bit	7	6	5	4	3	2	1	0
Byte								
0	Operation Code (5Bh)							
1	Reserved							IMMED
2	Reserved					Close Function		
3	Reserved							
4	(MSB) Logical Track Number							
5	(LSB)							
6	Reserved							
7	Reserved							
8	Reserved							
9	Control Byte							

6.3.2.2 IMMED

The IMMED bit allows execution of the close function as an immediate operation. If IMMED is zero, then the requested close operation is processed to completion prior to returning status. If IMMED is one, then status is returned once the close operation has begun.

6.3.2.3 Close Functions

The Close Functions are specific to media type. See 6.3.3.1 through . If the Close Function is reserved for the currently mounted medium, the command shall be terminated with CHECK CONDITION status and SK/ASC/ASCQ values shall be set to ILLEGAL REQUEST/INVALID FIELD IN CDB.

6.3.2.4 Logical Track Number

Logical Track Number meanings are defined within the specific Close Function cases.

6.3.3 Command Processing

6.3.3.1 Close Function Definitions for CD-R/-RW

6.3.3.1.1 Reserved Close Functions

Close Functions 000b, 011b, 100b, 101b, 110b, and 111b are reserved when CD-R/-RW media is present.

If the Close Function is 000b, 011b, 100b, 101b, 110b, or 111b when CD-R/-RW is the mounted medium and not MRW formatted, the command shall be terminated with CHECK CONDITION status and SK/ASC/ASCQ values shall be set to ILLEGAL REQUEST/INVALID FIELD IN CDB.

6.3.3.1.2 Close Function 001b: Close a Logical Track

If this is the incomplete track, the Drive shall pad with all zero user data to the minimum length of 4 seconds. No other padding shall be done.

If this is a partially recorded or empty reserved track, the Drive shall pad until the end of the track. In the case of an empty track, the Drive shall write the track according to the Write Parameters Page. If the Write Parameters Page is inconsistent with the PMA, CHECK CONDITION status shall be returned and SK/ASC/ASCQ shall be set to ILLEGAL REQUEST/ILLEGAL MODE FOR THIS TRACK. For a partially recorded reserved track, the Drive shall continue writing in the same mode as the data already recorded.

6.3.3.1.3 Close Function 010b: Close Session/Finalize disc

If some track in the last Session is open, terminate the command with CHECK CONDITION status and set SK/ASC/ASCQ values to ILLEGAL REQUEST/SESSION FIXATION ERROR – INCOMPLETE TRACK IN SESSION.

Behavior of the closing operation is dependent on the Multi-Session field in the Write Parameters Page (05h). If the last session is empty, the command shall be terminated with GOOD status and no recording shall occur.

6.3.3.2 Close Function Definitions for DVD-R/-RW

6.3.3.2.1 Reserved Close Functions

Close Functions 000b, 100b, 101b, 110b, and 111b are reserved when DVD-R/-RW media is present.

If the Close Function is 000b, 100b, 101b, 110b, or 111b when DVD-R/-RW is the mounted medium, the command shall be terminated with CHECK CONDITION status and SK/ASC/ASCQ values shall be set to ILLEGAL REQUEST/INVALID FIELD IN CDB.

6.3.3.2.2 Close Function 001b: Close a Logical Track

If this is the Partially Recorded Reserved RZone or the Empty Reserved Rzone, the Drive shall pad the Rzone with 00h bytes. If the Rzone status is Invisible, no close operation is to be done. In the case of an Incomplete Rzone, no padding is to be done and the cached RMD shall be written into the RMA.

6.3.3.2.3 Close Function 010b: Close Session

If all Rzones in the last Session are not complete, the command shall be terminated with CHECK CONDITION status and sense bytes SK/ASC/ASCQ shall be set to ILLEGAL REQUEST/SESSION FIXATION ERROR – INCOMPLETE TRACK IN SESSION. If any empty or partially recorded, reserved Rzones exist in the incomplete Session, the command shall be terminated with CHECK CONDITION status and sense bytes SK/ASC/ASCQ shall be set to ILLEGAL REQUEST/EMPTY OR PARTIALLY WRITTEN RESERVED TRACK. Behavior of the closing operation is dependent on the Multisession/Border field in the Write Parameters Mode Page (05h). Closing an empty Session/Border shall not result in an error and a write to the media shall not occur.

For DVD-RW media, when the last Bordered Area is in the intermediate state, Lead-in and/or Border-out are recorded to make the Bordered Area complete state. If the Bordered Area is to be closed that is the first one, Lead-in and Border-out shall be recorded. If the Bordered Area is to be closed that is second or later one, only the Border-out shall be recorded.

6.3.3.2.4 Close Function 011b: Finalize the disc

For DVD-RW media, if the disc is in DVD-RW restricted overwrite mode and the last Bordered Area is complete state and Lead-out is not written, Lead-out shall be appended after the last Border-out. If the last Bordered Area is intermediate state, Border-out and Lead-out is recorded. If the disc is not formatted, the Drive shall report CHECK CONDITION status, 5/24/00 INVALID FIELD IN CDB.

For all other media, the command shall be terminated with CHECK CONDITION status and SK/ASC/ASCQ values shall be set to ILLEGAL REQUEST/INVALID FIELD IN CDB.

6.3.3.3 Close Function Definitions for DVD-R DL

6.3.3.3.1 Reserved Close Functions

Close Functions 000b, 011b, 100b, 101b, 110b, and 110b are reserved when DVD-R DL media is present.

If the Close Function is 000b, 011b, 100b, 101b, 110b, or 110b when DVD-R DL is the mounted medium, the command shall be terminated with CHECK CONDITION status and SK/ASC/ASCQ values shall be set to ILLEGAL REQUEST/INVALID FIELD IN CDB.

6.3.3.3.2 Close Function 001b: Close a Logical Track

When the recording mode is Incremental Recording, closing an Rzone on DVD-R DL is the same as closing an Rzone on DVD-R.

When the recording mode is Layer Jump recording, closing an Rzone is different since the Rzone occupies both layers. Unrecorded blocks of an Rzone shall be padded by the Drive when the Rzone is closed. The Blank Area between a Complete Rzone and the Rzone to be closed may be padded during the Rzone closing operation (e.g., A Blank Area on L1 between the two Rzones). The Blank Area that is adjacent to a non-Complete Rzone shall not be padded.

When an Invisible Rzone is closed, no action is performed. When the disc or the Border is closed, the Shifted Middle Area or Border-out is recorded from the NWA of the Invisible Rzone.

When an Incomplete Rzone of Manual Layer Jump or Regular Interval Layer Jump is closed, a Complete Rzone and Invisible Rzone are created. The LRA of new Complete Rzone is the same address of the LRA of old Incomplete Rzone. LRA means logical block address of the latest recorded user data sector.

When the NWA of an Incomplete Rzone is located on L0, a new Invisible Rzone is created from the NWA. The last sector of the ECC block that contains the last recorded sector on L0 becomes Layer Jump Address of the Complete Rzone. The unrecorded part of L1 shall be padded. If the previous Rzone is a Complete Rzone, the Blank Area may be padded.

6.3.3.3.3 Close Function 010b: Close Session

When the recording mode is Incremental Recording, the disc is single session. Otherwise, the description of closing the session on DVD-R DL is the same as DVD-R.

The Border Zone and multi-border recording are defined only for Layer Jump recording on DVD-R DL with Format 4 RMD.

The Border Zone size is dependent on its starting address. The Border-out start address shall be located after PSN 3FEFFh. The Drive shall pad with 00h data through PSN 3FEFFh when Bordered Area is closed and user data is recorded less than LBA 0FEFFh. The Next Border-in start address of Empty/Incomplete Bordered Area is calculated from the Start PSN of the first Rzone in the Bordered Area.

In Layer Jump recording mode, when the remaining user data capacity is not sufficient to record Border-out, the Border-out is recorded differently. When the remaining area is less than the Border-out size, the Border-out size is reduced to fit the remaining data recordable area and a part of Border-out (7 ECC blocks) is recorded at the innermost Middle Area with the Middle Area attribute. This assures the proper linear logical volume space.

When a Border is to be closed, the replacement data on a ECC block of an AP are copied to both Superficial Border-out and Superficial Border-in. If a ECC block of an AP is remapped, the corresponding RBVF shall be set to 1 except when the remapping is canceled in the first Bordered Area.

6.3.3.4 Close Function Definitions for DVD+R

6.3.3.4.1 Reserved Close Functions

Close Functions 000b, 011b, 100b, and 111b are reserved when DVD+R media is present.

If the Close Function is 000b, 011b, 100b, or 111b when DVD+R is the mounted medium, the command shall be terminated with CHECK CONDITION status and SK/ASC/ASCQ values shall be set to ILLEGAL REQUEST/INVALID FIELD IN CDB.

6.3.3.4.2 Close Function 001b: Close the Logical Track

If the current track is reserved and blank or partially written, the Drive shall pad the track to its defined length. User data areas in all pad sectors shall be zero filled. If the track being closed is the incomplete track and the incomplete track is not blank, then a new Session DCB shall be appended into the Session Identification Zone defining the existence of the track. If the track being closed is the incomplete track and the incomplete track is blank, then the command shall be terminated with GOOD status and sense data shall be set to NO SENSE/NO ADDITIONAL INFORMATION.

6.3.3.4.3 Close Function 010b: Close Session

If not all Tracks in the last Session are closed, the DVD+R Drive shall terminate this command with CHECK CONDITION Status and sense data shall be set to ILLEGAL REQUEST/SESSION FIXATION ERROR/ INCOMPLETE TRACK IN SESSION.

Without closing the session, determine the number of ECC blocks remaining if the session is closed. If that number is less than 65, the disc shall be finalized. Otherwise, the session should be closed.

If the session being closed is session number 154, when the close session is requested, the Drive shall instead finalize the disc.

6.3.3.4.4 Close Function 101b: Finalize the Disc with minimal radius

Close the last session and finalize the disc. Once this close function has been processed, no more writing to the disc is allowed. If not all Tracks in the last Session are closed, the DVD+R Drive shall terminate this command with CHECK CONDITION Status and sense data shall be set to ILLEGAL REQUEST/SESSION FIXATION ERROR/ INCOMPLETE TRACK IN SESSION.

In order to assure maximum interchange compatibility with read only devices, Guard Zone 2 shall be recorded to a device defined PSN that approximates a disc radius of 30 mm. Suggested value: 70DE0h (462 304).

6.3.3.4.5 Close Function 110b: Finalize the Disc

Close the last session and finalize the disc. Once this close function has been processed, no more writing to the disc is allowed. If not all Tracks in the last Session are closed, the DVD+R Drive shall terminate this command with CHECK CONDITION Status and sense data shall be set to ILLEGAL REQUEST/SESSION FIXATION ERROR/ INCOMPLETE TRACK IN SESSION.

6.3.3.5 Close Function Definitions for DVD+R DL

6.3.3.5.1 Reserved Close Functions

Close Functions 000b, 011b, and 111b are reserved when DVD+R DL media is present.

If the Close Function is 000b, 011b, or 111b when DVD+R DL is the mounted medium, the command shall be terminated with CHECK CONDITION status and SK/ASC/ASCQ values shall be set to ILLEGAL REQUEST/INVALID FIELD IN CDB.

6.3.3.5.2 Close Function 001b: Close a Logical Track

Close the fragment associated with the track number in the CDB as follows:

If the specified fragment is reserved and either blank or partially written, the DVD+R Double Layer Drive shall pad the fragment to its defined length. User data areas in all pad sectors shall be zero filled. If the fragment being closed is the incomplete fragment and the incomplete fragment is not blank, then a new DCB shall be appended into the Session Identification Zone defining the existence of the fragment. If the fragment being closed is the incomplete fragment and the incomplete fragment is blank, then the command shall be terminated with GOOD status and sense data shall be set to NO SENSE/NO ADDITIONAL INFORMATION.

6.3.3.5.3 Close Function 010b: Close Session

If the session is not session 1 and finalization is not required, closing the session will not cause any lead-out recording to be performed. When the first session is closed, a nominal lead-out shall be recorded on L1. The close process is described as follows:

1. If the disc has been finalized, the command shall be terminated with GOOD status.
2. If the disc contains an open session and the open session is blank, the command shall be terminated with GOOD status.
3. If the disc contains an open session, and the open session is not blank, then the Drive shall verify that each defined fragment within the session is closed and that the incomplete fragment is blank. If this verification fails, the command shall be terminated with CHECK CONDITION Status and sense bytes SK/ASC/ASCQ shall be set to ILLEGAL REQUEST/SESSION FIXATION ERROR/ INCOMPLETE TRACK IN SESSION.
4. If the session is session 1, the Lead-in Zone shall be recorded. If the session is not session 1, the session Intro shall be recorded.
5. Resources for adding new sessions may be exhausted, thereby requiring finalization.
 - a) If upon completion of the closure, less than 65 ECC blocks would remain, the disc shall be finalized.
 - b) If the TOC Zone contains exactly one available entry, then the TOC Zone will be full once the instance of this session is recorded. In this case, the disc shall be finalized.

Otherwise, the session closure shall be recorded, the TOC Zone shall be updated to include this session's instance, and the disc shall be left open.
6. If the last ECC block of the session closure is on L1 and the middle zones are not recorded, the middle zones shall be recorded.

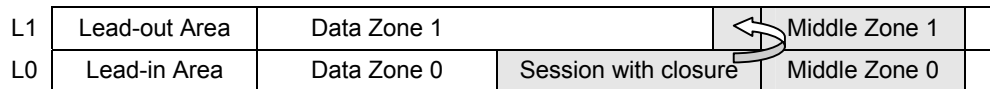

7. If the session just closed is session 1 the nominal the lead-out shall be recorded on L1.

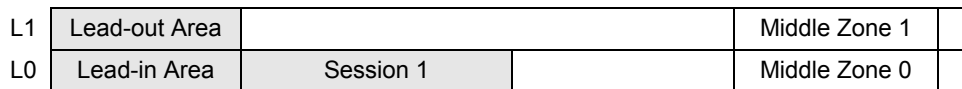

6.3.3.5.4 Close Function 100b: Close Session with minimal radius

If the session is not session 1 and finalization is not required, closing the session will not cause any lead-out recording to be performed. When the first session is closed, an extended lead-out shall be recorded on L1 when conditions permit. The close process is described as follows:

1. If the disc has been finalized, the command shall be terminated with GOOD status.
2. If the disc contains an open session and the open session is blank, the command shall be terminated with GOOD status.
3. If the disc contains an open session, and the open session is not blank, then the Drive shall verify that each defined fragment within the session is closed and that the incomplete fragment is blank. If this verification fails, the command shall be terminated with CHECK CONDITION Status and sense bytes SK/ASC/ASCQ shall be set to ILLEGAL REQUEST/SESSION FIXATION ERROR/ INCOMPLETE TRACK IN SESSION.
4. If the session is session 1, the Lead-in Zone shall be recorded. If the session is not session 1, the session Intro shall be recorded.
5. Resources for adding new sessions may be exhausted, thereby requiring finalization.
 - a) If the last ECC block of the session data is at or beyond the start of the extended Lead-out area, the disc shall be finalized and the command shall be terminated.
 - b) If upon completion of the closure, less than 65 ECC blocks would remain, the disc shall be fully finalized, and the command shall be terminated.
 - c) If the TOC Zone contains exactly one available entry, then the TOC Zone will be full once the instance of this session is recorded. In this case, the disc shall be finalized and the command shall be terminated.

Otherwise, the session closure shall be recorded, the TOC Zone shall be updated to include this session's instance, and the disc shall be left open.

6. If the last ECC block of the session closure is on L1 and the middle zones are not recorded, the middle zones shall be recorded.

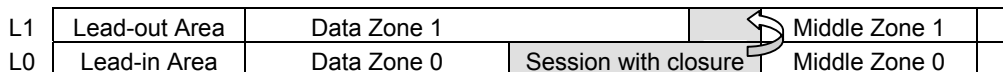

7. If the session just closed is session 1, and the L0 middle zone start address is at least at a 30 mm radius, the extended lead-out shall be recorded on L1.

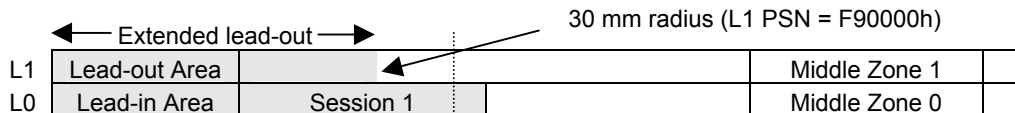

8. If the session just closed is session 1, and the L0 middle zone start address is less than a 30 mm radius (approximately LBA 40000h), the disc shall be finalized. If recording is completed within L0, the L0 middle zone start address shall be moved to immediately following the last recorded data on L0 before finalizing the disc. If the L0 middle zone ends prior to the 30mm radius, it is recommended that the middle zone recording be extended to the 30mm location.

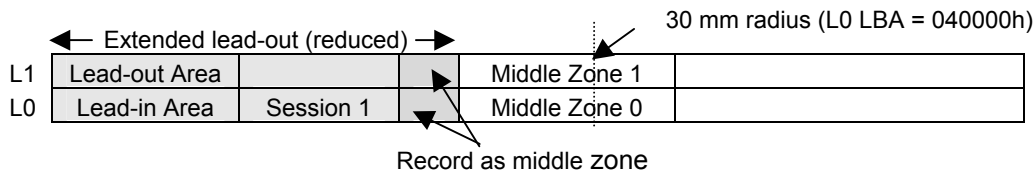

6.3.3.5.5 Close Function 101b: Finalize with Minimal Radius

If the disc has been finalized, then the command shall be terminated with GOOD status and sense bytes SK/ASC/ASCQ shall be set to NO SENSE/NO ADDITIONAL SENSE.

If the disc has not been finalized, finalization shall proceed as follows:

First ensure that L0 is completed:

1. If the L0 middle zone has been written, then the session to close is on L1. If the L0 middle zone ends prior to the 30 mm radius, the middle zone recording shall be extended to the 30 mm location.
2. If the L0 middle zone has not been written, then completing L0 is performed as follows:
 - a) If recording is completed within L0, the L0 middle zone start address shall be changed to the first ECC block after the last recorded data.

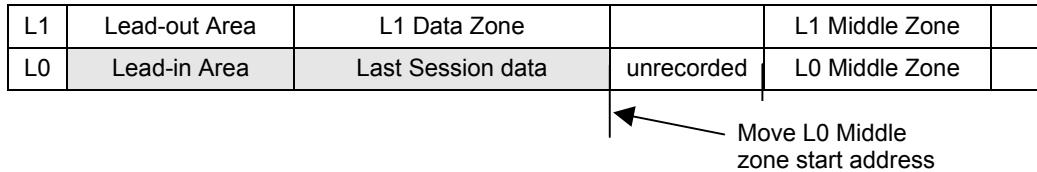

- b) The session intro (Lead-in, if session 1) shall be recorded. The L0 middle zone shall be recorded to a nominal length starting at the L0 middle zone start address.
- c) If the L0 middle zone ends prior to the 30 mm radius, the middle zone recording shall be extended to the 30 mm location.

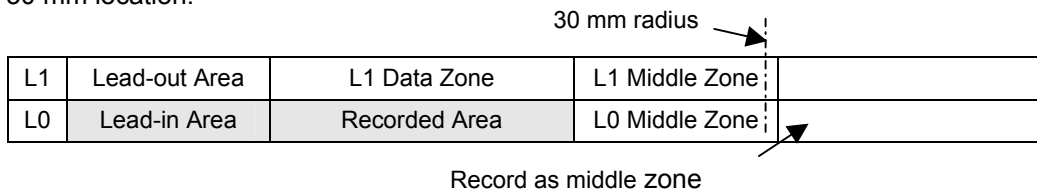

Next complete L1:

1. Write the L1 middle zone. It is strongly recommended that the L1 middle zone start at the radially equivalent position at which the L0 middle zone ends. The L1 middle zone recording should end at the radially equivalent position of the start of the L0 middle zone.
2. If the last session intro area is on L1, record the session intro.
3. All remaining, unrecorded L1 data zone ECC blocks shall be recorded as lead-out. If unrecorded ECC blocks remain within the lead-out area, those ECC blocks shall be recorded as lead-out.

6.3.3.5.6 Close Function 110b: Finalize

In order to maximize read compatibility with DVD-RO devices, it is recommended to use close function 101b. Close function 101b is preferred due to its minimal radius requirements.

If the disc has been finalized, then the command shall be terminated with GOOD status and sense bytes SK/ASC/ASCQ shall be set to NO SENSE/NO ADDITIONAL SENSE.

If the disc has not been finalized, finalization shall be performed as follows:

First ensure that L0 is completed:

1. If the L0 middle zone has been written, then the session to close is on L1.
2. If the L0 middle zone has not been written, then completing L0 is performed as follows:
 - a) If recording is completed within L0, the L0 middle zone start address shall be changed to the first ECC block after the last recorded data.

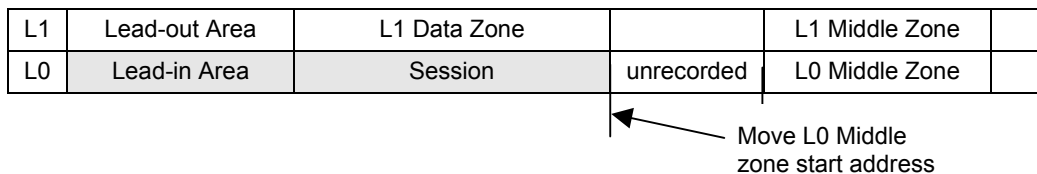

- b) The session intro (Lead-in if session 1) shall be recorded. The L0 middle zone shall then be recorded to a nominal length starting at the L0 middle zone start address.

Next complete L1:

1. Write the L1 middle zone. It is strongly recommended that the L1 middle zone start at the radially equivalent position at which the L0 middle zone ends. The L1 middle zone recording should end at the radially equivalent position of the start of the L0 middle zone.
2. If the last session intro area is on L1, record the session intro.
3. All remaining, unrecorded L1 data zone ECC blocks shall be recorded as lead-out. If unrecorded ECC blocks remain within the lead-out area, those ECC blocks shall be recorded as lead-out.

6.3.3.6 Close Function Definitions for DVD+RW

6.3.3.6.1 Reserved Close Functions

Close Functions 001b, 100b, 101b, 110b, and 111b are reserved when DVD+RW media is present.

If the Close Function is 001b, 100b, 101b, 110b, and 111b when DVD+RW is the mounted medium, the command shall be terminated with CHECK CONDITION status and SK/ASC/ASCQ values shall be set to ILLEGAL REQUEST/INVALID FIELD IN CDB.

6.3.3.6.2 Close Function 000b: Quick Stop Background Format

Optional behavior for DVD+RW media is defined. If a background format is in progress and de-icing is not completed, the format de-icing operation shall be stopped at some DVD+RW ECC block boundary. No further writing shall occur. If the medium mounted is DVD+RW and there is no background format in progress, then no operation shall occur and this shall not be considered an error. In this case, the Drive shall support FDCB bit maps.

6.3.3.6.3 Close Function 010b: Compatibility Stop Background Format with minimal radius

If a background format is in progress, the format operation shall be stopped and the disc shall be structured for removal according to the [DVD+Ref2] for the specific purpose of providing DVD-RO compatibility. In general, this means that a partial lead-in shall be written, a temporary lead-out shall be appended and all unrecorded gaps between lead-in and lead-out shall be format written. The radius difference between the start of the temporary lead-out and the end of the temporary lead-out shall approximate 1 mm. The data zone shall be expanded to ensure that the total recorded area reaches at least a radius of 30 mm.

6.3.3.6.4 Close Function 011b: Compatibility Stop Background Format

If a background format is in progress, the format operation shall be stopped and the disc shall be structured for removal according to the [DVD+Ref2] for the specific purpose of providing DVD-RO compatibility. In general, this means that a partial lead-in shall be written, a temporary lead-out shall be appended and all unrecorded gaps between lead-in and lead-out shall be format written. The radius difference between the start of the temporary lead-out and the end of the temporary lead-out shall approximate 1 mm.

6.3.3.7 Close Function Definitions for DVD+RW DL

6.3.3.7.1 Reserved Close Functions

Close Functions 001b, 100b, 101b, 110b, and 111b are reserved when DVD+RW DL media is present.

If the Close Function is 001b, 100b, 101b, 110b, and 111b when DVD+RW DL is the mounted medium, the command shall be terminated with CHECK CONDITION status and SK/ASC/ASCQ values shall be set to ILLEGAL REQUEST/INVALID FIELD IN CDB.

6.3.3.7.2 Close Function 000b: Quick Background Format

Optional behavior for DVD+RW DL media is defined. If a background format is in progress and de-icing is not completed, the format de-icing operation shall be stopped after the next layer 1 increment format write has completed. If the formatting is Quick Start, then each ECC block of the lead-in beyond the Initial Zone should be initialized. No further writing shall occur. If the medium mounted is DVD+RW DL and there is no background format in progress, then no operation shall occur and this shall not be considered an error.

6.3.3.7.3 Close Function 010b: Compatibility Stop Background Format with minimal radius

If a background format is in progress, the format operation shall be stopped and the disc shall be structured for removal according to the [DVD+Ref4] for the specific purpose of providing DVD-RO compatibility. The data zone shall be expanded to ensure that the total recorded area reaches at least a radius of 30 mm.

6.3.3.7.4 Close Function 011b: Compatibility Stop Background Format

If a DVD+RW DL background format is in progress, the format operation shall be stopped and the disc shall be structured for removal according to the [DVD+Ref4] for the specific purpose of providing DVD-RO compatibility.

6.3.3.8 Close Function Definitions for HD DVD-R

6.3.3.8.1 Reserved Close Functions

Close Functions 000b, 011b, 100b, 101b, and 111b are reserved when HD DVD-R media is present.

If the Close Function is 000b, 011b, 100b, 101b, or 111b when HD DVD-R is the mounted medium, the command shall be terminated with CHECK CONDITION status and SK/ASC/ASCQ values shall be set to ILLEGAL REQUEST/INVALID FIELD IN CDB.

6.3.3.8.2 Close Function 001b: Close Logical Track

Logical Track Number contains the number of the Rzone to close. If this is the Partially Recorded Reserved Rzone or the Empty Reserved Rzone, the Drive shall pad the Rzone with 00h bytes. If the Rzone status is Invisible, no close operation is to be done. In the case of an Incomplete Rzone, no padding is to be done and the cached RMD shall be written into the RMA/RMZ.

6.3.3.8.3 Close Function 010b: Close Session

If not all Rzones in the last Session/Border are complete, the command shall be terminated with CHECK CONDITION status and sense bytes SK/ASC/ASCQ shall be set to ILLEGAL REQUEST/SESSION FIXATION ERROR – INCOMPLETE TRACK IN SESSION. If an empty or partially recorded, reserved Rzone exists in the incomplete Session/Border, the command shall be terminated with CHECK CONDITION status and sense bytes SK/ASC/ASCQ shall be set to ILLEGAL REQUEST/EMPTY OR PARTIALLY WRITTEN RESERVED TRACK. Closing an empty Session/Border does not cause an error and a write to the media shall not occur. If the Bordered Area is to be closed that is the first one, Lead-in and Border-out shall be recorded. If the Bordered Area is to be closed that is second or later one, only the Border-out shall be recorded.

Closing an incomplete Bordered Area shall cause the Lead-in or Border-in and Border-out to be written for the incomplete Bordered Area. If the unrecorded ECC blocks in Current RMZ exist and the unrecorded ECC blocks in RDZ do not exist, the command shall be terminated with CHECK CONDITION status and sense bytes SK/ASC/ASCQ shall be set to ILLEGAL REQUEST/RDZ IS FULL.

6.3.3.8.4 Close Function 110b: Finalize the disc

Finalize the disc. If the last Border is the incomplete Border, the Border-out whose attribute is a Data Lead-out shall be written. If the last Border is empty Border, the Terminator shall be appended to the last Border-out. Once the Border-out whose attribute is a Data Lead-out or the Terminator has been written, data shall not be appended to the medium after the Border-out or the Terminator.

6.3.3.9 Close Function Definitions for BD-R

6.3.3.9.1 Reserved Close Functions

Close Functions 000b, 011b, 100b, 101b, and 111b are reserved when BD-R media is present.

If the Close Function is 000b, 011b, 100b, 101b, or 111b when BD-R is the mounted medium, the command shall be terminated with CHECK CONDITION status and SK/ASC/ASCQ values shall be set to ILLEGAL REQUEST/INVALID FIELD IN CDB.

6.3.3.9.2 Close Function 001b: Close Logical Track

Close the Logical Track (SRR) identified by Logical Track Number field (T) in the CDB.

A BD-R SRR is closed by removing its number from the list of open SRRs in the SRR1. Padding is not required. Since the disc is not finalized, the updated SRR1 shall be written into the current TDMA as a TDMS update unit. The actual write may be deferred.

If T is the invisible SRR and the invisible SRR is blank, then the command shall be terminated with GOOD status and sense data shall be set to NO SENSE/NO ADDITIONAL INFORMATION. If T is the invisible SRR and the invisible SRR is not blank, then the length of T shall be set to its recorded length, creating a new, blank invisible SRR with Logical Track Number = T+1.

If a Logical Track is closed, it may contain some blank Clusters. If the Host chooses to read a sector from a blank Cluster of a closed Logical Track, the Drive shall return all zeros in place of sector data.

6.3.3.9.3 Close Function 010b: Close Session

Close the currently open session on a SRM-POW Disc.

If the currently mounted disc is formatted SRM+POW, the command shall be terminated with CHECK CONDITION and sense bytes SK/ASC/ASCQ shall be set to ILLEGAL REQUEST/INVALID FIELD IN CDB.

If the currently mounted disc is SRM and the currently open session is empty, the command shall be terminated with GOOD status.

If the currently mounted disc is SRM-POW and the currently open session is non-empty, each open SRR in the last Session shall be closed by the Drive prior to closing the session.

6.3.3.9.4 Close Function 110b: Finalize Disc

Close the last session and finalize the disc. Once this close function has been processed, no more writing to the disc is allowed. Each open SRR in the last Session shall be closed by the Drive prior to closing the session.

The disc shall be closed by writing the four DMA zones of the disc and the DMA access indicator.

6.3.3.10 Close Function Definitions for the MRW Format

6.3.3.10.1 Reserved Close Functions

Close Functions 000b, 001b, 011b, 100b, 101b, 110b, and 111b are reserved when MRW formatted/formatting media is present.

If the Close Function is , 001b, 011b, 100b, 101b, 110b, or 111b when a MRW formatted/formatting disc is the mounted medium, the command shall be terminated with CHECK CONDITION status and SK/ASC/ASCQ values shall be set to ILLEGAL REQUEST/INVALID FIELD IN CDB.

6.3.3.10.2 Close Function 010b: Stop Background Format

If no background is in progress, the command shall be terminated with GOOD status. If a background format is in progress, the format operation shall be stopped and the disc shall be structured for removal. For CD-RW media, the *CD-MRW Defect Management & Physical Formatting Specification*, defines the structuring. For DVD+RW media, the *DVD+MRW Defect Management & Physical Formatting Specification* defines the structuring.

6.3.3.11 General Execution Characteristics

If the Drive is unable to write to the currently mounted medium, error reporting should follow the guidelines according to 4.1.6.3.

During a Close Track/Session operation that began with the IMMED bit set to one, the Drive shall respond to commands as follows:

- a) In response to all commands except REQUEST SENSE, INQUIRY, GET CONFIGURATION, GET EVENT STATUS NOTIFICATION, and TEST UNIT READY, the Drive shall return CHECK CONDITION status and set SK/ASC/ASCQ to NOT READY/LOGICAL UNIT NOT READY/OPERATION IN PROGRESS.
- b) In response to the TEST UNIT READY command, the Drive should return CHECK CONDITION status and set SK/ASC/ASCQ to NOT READY/LOGICAL UNIT NOT READY/OPERATION IN PROGRESS. Some legacy implementations allowed for a GOOD status response to a TEST UNIT READY command. This behavior is not recommended.
- c) In response to the INQUIRY, GET CONFIGURATION, GET EVENT STATUS NOTIFICATION commands, the Drive shall respond as commanded.
- d) In response to the REQUEST SENSE command, unless an error has occurred, the Drive shall return with SK/ASC/ASCQ values set to NOT READY/LOGICAL UNIT NOT READY/LONG WRITE IN PROGRESS or NOT READY/LOGICAL UNIT NOT READY/OPERATION IN PROGRESS, with the sense key specific bytes set for progress indication.

If the Drive changes to a not ready state during execution, an Operational Change Event shall be generated. When execution is completed and the state returns to ready, an Operational Change Event shall be generated. If the Closing a Track or Session results in one or more features changing currency, an additional Operational Change Event shall be generated.

6.3.4 Timeouts

The CLOSE TRACK SESSION command belongs to timeout group 2 when IMMED is zero. The group 2 timeout value is only for Host information. The Drive shall not time group 2 timeout commands. Execution shall continue until completion.

When the IMMED is set to one, status shall be returned within a Group 1 timeout.

6.3.5 Error Reporting

When the command operation began with the CDB IMMED bit set to one, it is possible that a deferred error may be reported in some future command.

Recommended error reporting is defined in Table 239.

Table 239 — Recommended errors for CLOSE TRACK/SESSION Command

Error	Reference	May be Deferred
Unit Attention conditions	Table F.1	
CDB or parameter list validation errors	Table F.2	
Readiness errors	Table F.3	
Protocol errors	Table F.4	
General media access errors	Table F.5	√
Write errors	Table F.7	√
Hardware failures	Table F.8	√

6.4 ERASE (10) Command

6.4.1 Introduction

The ERASE (10) command requests that the Drive erase the specified number of blocks starting at the specified logical block address on the medium. The features associated with this command are shown in Table 240.

Table 240 — Features Associated with the ERASE (10) Command

Feature Number	Feature Name	Command Requirement
0022h	Sector Erasable	Mandatory
NOTE 1: The command requirement is valid only when the feature is current.		

6.4.2 The CDB and its Parameters

6.4.2.1 The CDB

The ERASE (10) CDB is shown in Table 241.

Table 241 — ERASE (10) CDB

Bit	7	6	5	4	3	2	1	0
Byte								
0	Operation Code (2Ch)							
1	Reserved					ERA	IMMED	Obsolete
2	(MSB) Logical Block Address (LSB)							
3								
4								
5								
6								
7	(MSB) Number of Blocks (LSB)							
8								
9	Control							

6.4.2.2 ERA

An ERA bit (Erase All) of one indicates that all remaining blocks on the medium shall be erased. If ERA is one and the number of blocks is not zero, the command shall be terminated with CHECK CONDITION status and SK/ASC/ASCQ shall be set to ILLEGAL REQUEST/INVALID FIELD IN CDB.

6.4.2.3 IMMED

If IMMED is zero, then the requested operation is processed to completion prior to returning status.

If IMMED is one, then status is returned once the operation has begun.

6.4.2.4 Logical Block Address

The Logical Block Address field contains the LBA at which erase operations shall begin.

6.4.2.5 Number of Blocks

Number of Blocks specifies the number of contiguous logical blocks that shall be erased when ERA is zero. If ERA is zero, a Number of Blocks of zero indicates that no blocks shall be erased. This condition shall not be considered an error and no data shall be erased. Any other value indicates the number of logical blocks that shall be erased.

6.4.3 Command Processing

As used here, erased means either the medium shall be erased, or a pattern shall be written on the medium that appears to the Drive as no data present. The blocks erased shall be considered blank for purposes of blank checking. Previous data recorded on the medium, if any, shall not be recoverable.

If the Drive is unable to write to the currently mounted medium, error reporting should follow the guidelines according to 4.1.6.3.

During an Erasing operation that began with the IMMED bit set to one, the Drive shall respond to commands as follows:

- a) In response to all commands except REQUEST SENSE, INQUIRY, GET CONFIGURATION, and GET EVENT STATUS NOTIFICATION, the Drive shall return CHECK CONDITION status and set SK/ASC/ASCQ to NOT READY/LOGICAL UNIT NOT READY/OPERATION IN PROGRESS.
- b) In response to the INQUIRY, GET CONFIGURATION, GET EVENT STATUS NOTIFICATION commands, the Drive shall respond as commanded.
- c) In response to the REQUEST SENSE command, unless an error has occurred, the Drive shall return a SK/ASC/ASCQ values set to NOT READY/LOGICAL UNIT NOT READY/OPERATION IN PROGRESS, with the sense key specific bytes set for progress indication.

If the Drive changes to a not ready state during execution, an Operational Change Event shall be generated. When execution is completed and the state returns to ready, an Operational Change Event shall be generated.

6.4.4 Timeouts

The ERASE command belongs to timeout group 1. When the IMMED bit in the CDB is set to one, timeouts are not permitted. Otherwise, if the command is terminated with CHECK CONDITION status due to a timeout, sense bytes SK/ASC/ASCQ shall be set to NOT READY/INSUFFICIENT TIME FOR OPERATION.

6.4.5 Error Reporting

When the command operation began with the CDB IMMED bit set to one, it is possible that a deferred error may be reported in some future command.

Recommended error reporting is defined in Table 242.

Table 242 — Recommended errors for ERASE (10) Command

Error	Reference	May be Deferred
Unit Attention conditions	Table F.1	
CDB or parameter list validation errors	Table F.2	
Readiness errors	Table F.3	
General media access errors	Table F.5	√
Write errors	Table F.7	√
Hardware failures	Table F.8	√

6.5 FORMAT UNIT Command

6.5.1 Introduction

The FORMAT UNIT command formats a medium into Host addressable logical blocks according to Host defined options. The medium may be certified and control structures created for the management of the medium and defects. The medium may or may not be altered.

The features associated with this command are shown in Table 243.

Table 243 — Features Associated with the FORMAT UNIT Command

Feature Number	Feature Name	Command Requirement ¹
0023h	Formattable	Mandatory
0028h	MRW	Mandatory when the Write bit is one
002Ah	DVD+RW Basic Format	Mandatory when the Write bit is one
003Ah	DVD+RW Dual Layer	Mandatory when the Write bit is one
0041h	BD Write	Mandatory
0051h	HD DVD Write	Mandatory for HD DVD-R
¹ The command requirement is valid only when the feature is current.		

6.5.2 The CDB and Its Parameters

6.5.2.1 The CDB

The FORMAT UNIT CDB is shown in Table 244.

Table 244 — FORMAT UNIT CDB

Bit	7	6	5	4	3	2	1	0
Byte								
0	Operation Code (04h)							
1	Reserved			FmtData	CmpList	Format Code		
2	Reserved							
3	(MSB) Interleave Value (LSB)							
4								
5	Control Byte							

6.5.2.2 FmtData

If the FmtData bit is zero, there is no parameter list. If FmtData is one, a parameter list is available from the Host. For all Multi-media Drives, FmtData shall be set to one. If FmtData is zero, the command shall be terminated with CHECK CONDITION status and SK/ASC/ASCQ shall be set to ILLEGAL REQUEST/INVALID FIELD IN CDB.

6.5.2.3 CmpList

The CmpList bit is used in conjunction with the DCRT (Disable Certification) bit to determine usage of the existing G1-list, G2-list and SDL to construct new G1-list and G2-list (Table 245) on DVD-RAM and HD DVD-RAM media. If CmpList is set to zero, then the parameter list provided is in addition to those already available to the Drive. If CmpList is set to one, then the parameter list is complete and the Drive is to ignore any existing parameters. On CD-RW, DVD-RW, DVD+RW, BD-R, BD-RE media and MRW formats, CmpList bit shall be set to zero.

Table 245 — DVD-RAM/HD DVD-RAM Defect List Handling

CmpList	DCRT	Certification	PDL			SDL	Remarks
			P-list	G1-list	G2-list		
0	0	Yes	Preserved	New from Certification	Disposed	Disposed	Slow initialization
0	1	No	Preserved	Preserved	Old + New from SDL	Disposed	Change linear replacement to slipping, quickly
1	0	Yes (Partial) Obsolete	Preserved	Old plus New from Certification	Disposed	Disposed	Create new defect list by disposing all except P-list and G1-list
1	1	No	Preserved	Preserved	Disposed	Disposed	Return to original slipping at the latest certification, quickly

6.5.2.4 Format Code

The Format Code identifies the parameter list format. The Format Code shall be set to one (001b).

6.5.2.5 Interleave Value

The Interleave Value field identifies the value to be used when formatting. Interleave Value shall be zero.

6.5.3 Format Parameter List

6.5.3.1 List Format

The FORMAT UNIT parameter list (Table 246) consists of three descriptors: the Format List Header, the Initialization Pattern Descriptor, and the Format Descriptor.

Table 246 — Format Unit Parameter List

Bit	7	6	5	4	3	2	1	0
Byte								
0 – 3	Format List Header							
4 – n	Initialization Pattern Descriptor (present when IP = 1)							
n+1 to n+8	Format Descriptor							

6.5.3.2 Format List Header

The Format List Header (Table 247) provides several format control bits. Drives that implement these bits give Hosts additional control over the formatting operation. If the Host attempts to select any function not implemented by the Drive, the Drive shall terminate the command with CHECK CONDITION status and SK/ASC/ASCQ values shall be set to ILLEGAL REQUEST/INVALID FIELD IN PARAMETER LIST.

Table 247 — Format List Header

Bit Byte	7	6	5	4	3	2	1	0
0	Reserved							
1	FOV	DPRY	DCRT	STPF	IP	Try-out	IMMED	VS
2	(MSB) Format Descriptor Length							
3	(LSB)							

If the Format Options Valid (FOV) bit is zero, the Drive shall use its default settings for the values of DPRY, DCRT, STPF, IP, and Try-out. When the FOV bit is zero, the Host should set DPRY, DCRT, STPF, IP, and Try-out to zero. If any of these bits are not zero, the Drive shall terminate the command with CHECK CONDITION status and set SK/ASC/ASCQ values to ILLEGAL REQUEST/INVALID FIELD IN PARAMETER LIST. If FOV is one, the Drive shall examine the setting of the DPRY, DCRT, STPF, IP, and Try-out.

The DPRY, DCRT, STPF, IP, and Try-out, IMMED, and VS bits are defined as follows:

- a) A Disable Primary (DPRY) bit, when set to zero, shall indicate that the Drive shall retain the manufacturer's certification list (PList). When set to one, shall indicate that the manufacturer's certification list be retained but not used for defect management. DPRY bit shall be set to zero. If DPRY is set to one, the Drive shall terminate the command with CHECK CONDITION status and SK/ASC/ASCQ values shall be set to ILLEGAL REQUEST/INVALID FIELD IN PARAMETER LIST.
- b) If the Disable Certification (DCRT) bit is set to zero, the Drive shall perform a vendor-specific medium certification operation. A DCRT bit of one indicates that the Drive shall not perform the vendor-specific medium certification process or format verification operation while executing the FORMAT UNIT command.
- c) The STPF bit is reserved. If STPF is not zero, the Drive shall terminate the command with CHECK CONDITION status and set SK/ASC/ASCQ values to ILLEGAL REQUEST/INVALID FIELD IN PARAMETER LIST.
- d) If the Initialization Pattern (IP) bit is set to zero, an initialization pattern descriptor is not included and that the Drive shall use its default initialization pattern. If IP is set to one, an initialization pattern descriptor is sent to the Drive as part of the FORMAT UNIT Parameter List. IP shall be set to zero. If IP is set to one, the command shall be terminated with CHECK CONDITION status and SK/ASC/ASCQ values shall be set to ILLEGAL REQUEST/INVALID FIELD IN PARAMETER LIST.
- e) If Try-out is set to zero, the Drive shall perform format the disc as specified. If Try-out is set to one, the Drive shall determine the possibility of formatting the media, but the Drive shall not write to the media. If formatting is possible, then the command shall be terminated with GOOD status. If the Drive determines that error free formatting is not possible, the command shall be terminated with CHECK CONDITION status and SK/ASC/ASCQ values shall be set to MEDIUM ERROR/MEDIUM FORMAT CORRUPTED.
- f) If the immediate (IMMED) bit is zero, status shall be returned only after the format operation has completed. If the IMMED bit is set to one, the Drive shall return status as soon as the CDB and the Format Descriptor have been validated and it is determined that the format process is able to begin.
- g) The Vendor Specific (VS) bit has a vendor-specific definition.

The Format Descriptor Length shall be set to 8. If any other value is found in this field, the Drive shall terminate the command with CHECK CONDITION status and SK/ASC/ASCQ values shall be set to ILLEGAL REQUEST/INVALID FIELD IN PARAMETER LIST.

6.5.3.3 Format Descriptor

When the CDB Format Code is 001b, a Format Descriptor is included in the FORMAT UNIT Parameter List. The Format Descriptor (Table 248) is an eight-byte entry.

Table 248 — Format Code 001b Format Descriptor

Bit Byte	7	6	5	4	3	2	1	0
0	(MSB)							
1	Number of Blocks							
2	(LSB)							
3								
4	Format Type					Format Sub-type		
5	(MSB) Type Dependent Parameter							
6								
7								

The Format Type field specifies the type of formatting. Sub-type identifies special characteristics for formatting the type. If not specified, the Sub-type field is reserved. Contents of the Number of Blocks field and the Type Dependent Parameter field depend on Format Type.

Table 249 — Format Types

Format Type	Description	Type Dependent Parameter
00h	Full Format for rewritable media	Block Length (0800h)
01h	Spare Area Expansion	Block Length (0800h)
04h	Zone Reformat	Zone Number
05h	Zone Format	Zone Number
10h	CD-RW/DVD-RW Full Format	CD Fixed Packet Size/ECC block size (16)
11h	CD-RW/DVD-RW Grow Session	CD Fixed Packet Size/ECC block size (16)
12h	CD-RW/DVD-RW Add Session	CD Fixed Packet Size/ECC block size (16)
13h	DVD-RW Quick Grow Last Border	ECC block size (16)
14h	DVD-RW Quick Add Border	ECC block size (16)
15h	DVD-RW Quick Format	ECC block size (16)
16h	HD DVD-R Test Zone Expansion	—
20h	Full Format with Sparing Parameters	Sparing Parameters
24h	MRW Format	New/Restart Format
26h	DVD+RW Basic Format	New/Restart Format
30h	BD-RE Full Format with Spare Areas	Sparing Parameters
31h	BD-RE Full Format without Spare Areas	Block Length (0800h)
32h	BD-R Full Format with Spare Areas	Sparing Parameters

6.5.4 Command Processing

6.5.4.1 Overview

If the Drive is unable to write to the currently mounted medium, error reporting should follow the guidelines according to 4.1.6.3.

6.5.4.2 Formatting According to Format Type

6.5.4.2.1 Format Type = 00h (Full Format)

Formatting the entire media is specified. Unless otherwise specified, the Sub-type field is reserved. Typically, the Number of Blocks field specifies the number of addressable blocks for the entire disc and the Type Dependent Parameter field specifies the Block Length.

6.5.4.2.1.1 CD-RW

The entire media shall be format written in fixed length packets using parameters from the Write Parameter Mode Page information. After formatting, the number of LBAs on the media shall be at least Number of Blocks. The Number of Blocks parameter may be rounded up. The Type Dependent Parameter field specifies the Block Length (0800h).

6.5.4.2.1.2 DVD-RAM

The defect list handling is specified by the combination of the CmpList bit and the DCRT bit as shown in Table 245. In the case that the CmpList bit is set to zero and the DCRT bit is set to one, the Number of Blocks field shall be ignored and the number of addressable blocks shall be retained. Otherwise, the Number of Blocks field specifies the number of addressable blocks for the whole disc. The Number of Blocks value shall be the value returned by the READ FORMAT CAPACITIES command. The Type Dependent Parameter field specifies the Block Length.

6.5.4.2.1.3 DVD-RW

This format operation is always available when DVD-RW media is present. The area from the beginning of the RMA to the end of the Lead-out shall be recorded. There is only one session on the medium and the number of logical tracks is one after this operation. The Disc Status field of Format 3 RMD shall be set to 12h when the operation is completed.

6.5.4.2.1.4 DVD+RW (both SL and DL)

If this format type is available for DVD+RW, it shall be defined identically to format type 26h.

6.5.4.2.1.5 HD DVD-RAM

The description for formatting HD DVD-RAM in format type 0 is identical to the description for DVD-RAM.

6.5.4.2.1.6 BD-RE

Format Type 00h requires that the Drive execute the formatting process by using its default User Data Zone size. The Drive ignores the Number of Blocks field, and the Block Length field. The Sub-type field is reserved. The default behavior of the format process is Quick Reformat.

The total User Data Zone on the disc shall be the default size as reported by the Format Type 00h format descriptor returned by READ FORMAT CAPACITIES command.

The Spare Area size shall be the default size as resulting from the default User Data Zone Size.

6.5.4.2.1.7 BD-R

Format Type 00h requires that the Drive execute the formatting process by using its default User Data Zone size, default spares allocation, and default TDMA allocation.

The Drive ignores the Number of Blocks field, and the Type Dependent Parameter.

Format Sub-type selects a sub-type of format Type 00h for BD-R as shown in Table 250.

Table 250 — Format Sub-type Field

Sub-type Value	Description
00b	SRM+POW
01b	SRM-POW
10b	RRM
11b	Reserved

The total User Data Zone on the disc shall be the default size as reported by the Format Type 00h format descriptor returned by READ FORMAT CAPACITIES command.

As a part of the format process, the Drive shall allocate TDMA and spare areas according to vendor specific defaults. Table 251 shows an example of defaults for different BD-R discs.

Table 251 — Example of Default Allocations for Format Type 0, Sub-type 0

BD-R Disc	Allocations			
	Area	Spares	TDMA	Totals
80 mm Single Layer	ISA0	2 048	2 048	4 096
	OSA0	0	0	0
80 mm Dual Layer	ISA0	2 048	2 048	4 096
	OSA0	0	0	0
	OSA1	0	0	0
	ISA1	2 048	2 048	4 096
120 mm Single Layer	ISA0	2 048	2 048	4 096
	OSA0	4 096	4 096	8 192
120 mm Dual Layer	ISA0	2 048	2 048	4 096
	OSA0	4 096	4 096	8 192
	OSA1	4 096	4 096	8 192
	ISA1	2 048	2 048	4 096

6.5.4.2.2 Format Type = 01h (Spare Area Expansion)

This Format Type is defined for DVD-RAM, HD DVD-RAM, and BD-RE media.

6.5.4.2.2.1 DVD-RAM and HD DVD-RAM

In order to keep more Spare area, this formatting is used. Eventually the capacity of the formatted area is reduced. Therefore, this formatting type is just available with the case of reduction of formatted capacity.

The Drive shall ignore the defect list handling specified by the combination of the CmpList bit and the DCRT bit. The defect list entries and the written user data within the range of the area that is specified by this command shall be preserved through the execution of this command. The number of Blocks field specifies the number of addressable blocks for the whole disc and the Type Dependent Parameter field specifies the Block Length. Neither field is changeable from the values reported by the READ FORMAT CAPACITIES command (6.24).

6.5.4.2.2.2 BD-RE

If the Expand bit is set to one in the Formattable Feature descriptor, Format Type 01h is supported and is used to convert some of the User Data Zone into Spare Area. Spare areas are permitted to be expanded when the total spare area size is non-zero. If the current disc formatting has no spare area allocated, then this command shall be terminated with CHECK CONDITION status and the sense bytes SK/ASC/ASCQ shall be set to ILLEGAL REQUEST/INVALID FIELD IN PARAMETER LIST.

If the Number of Blocks field does not provide space for additional spare area, the command shall be terminated with GOOD status.

Only the last spare area may be expanded. On a SL disc, only the OSA0 may be expanded. On a DL disc, only the ISA1 may be expanded.

The Host should determine the location and size of the part of the User Data Zone that it expects to be taken as spares. User Data in that area should be preserved by the Host and all address links to that User Data should be removed.

Although defect status may change, each registered defect within the range of the area taken as spares shall remain a registered defect after the execution of this command. The Number of Blocks field specifies the number of addressable blocks for the whole disc and the Type Dependent Parameter field specifies the Block Length.

Once formatting has completed, if space is available, the Host should restore any data that was copied off the disc.

6.5.4.2.3 Format Type = 04h (Zone Reformat)

This Format Type is defined for DVD-RAM and HD DVD-RAM media.

The Zoned formatting for a zone of the media is specified where the size of zone is not constant across zones. The defect list handling is specified by the combination of the CmpList bit and the DCRT bit as shown in Table 245. The Number of Blocks field specifies the number of addressable blocks for the zone and the Type Dependent Parameter field specifies the Zone number of the zone to be formatted. If a spare sector is used as a replacement for another zone so that the zoned formatting is unable to be preformed, the command shall be terminated with a CHECK CONDITION status, SK/ASC/ASCQ values shall be set to MEDIUM ERROR/ZONED FORMATTING FAILED DUE TO SPARE LINKING, and the sense key specific bytes set to zone number of the first zone that has a spare linking into the designated zone.

The discarding of G1-list, G2-list, and SDL is only applicable to defects within the zone being reformatted.

6.5.4.2.4 Format Type = 05h (Zone Format)

This Format Type is defined for DVD-RAM and HD DVD-RAM media.

The Zoned formatting for a zone of the media is specified where the size of zone is constant for each zone, e.g. floppy media where each track is labeled a zone. The Number of Blocks field specifies the number of addressable blocks for the zone and the Type Dependent Parameter field specifies the Zone number of the zone to be formatted. The zone number shall be in the range of 0 to the Type Dependent Parameter reported in READ FORMAT CAPACITIES command (6.24).

6.5.4.2.5 Format Type = 10h (CD/DVD-RW Full Format)

Formatting to create a session on CD/DVD-RW media is specified. The created session shall become the only session on the medium. The Number of Blocks field specifies the number of addressable blocks for the new session and the Type Dependent Parameter field specifies the Fixed Packet Size for CD or set to ECC block size (16) for DVD-RW. The number of blocks field may be adjusted to a value less than or equal to the values reported by the READ FORMAT CAPACITIES command (6.24). The Drive shall round the Number of Blocks up to be an integral multiple of the packet size for CD or set to ECC block size (16) for DVD-RW. The Packet Size field shall not be adjusted. In the case of CD media, if a different Fixed Packet Size is desired, the Host should modify the Write Parameters Page.

On DVD-RW media, this format operation is always available. The track number in the created session is one after this operation. The Disc Status field of Format 3 RMD shall be set to 12h when the operation is completed.

6.5.4.2.6 Format Type = 11h (CD/DVD-RW Grow Session)

In the case of CD-RW, formatting to expand the last session is specified. The Number of Blocks field specifies the number of addressable blocks to be enlarged and the Type Dependent Parameter field specifies the Packet Length. The Number of Blocks field may be adjusted to a value greater than the existing Session size and less than or equal to the values reported by the READ FORMAT CAPACITIES command. The Drive shall round the Number of Blocks up to be an integral multiple of the packet size. The Packet Size field shall not be adjusted.

In the case of DVD-RW, formatting to expand the last session and enter the last session program area into intermediate state is specified. The Number of Blocks field specifies the number of addressable blocks to be added to current session capacity and the Type Dependent Parameter field is set to ECC block size (16). The Drive shall round the Number of Blocks up to be an integral multiple of the ECC block size.

This format operation is available only when a disc is in restricted overwrite mode and the last session is in a complete state. Growing of session operation shall start from the next sector of End Sector Number of Track #n field that is corresponded to the last track. End PSN of Data Area and Start PSN of the current Lead-out/Border-out field of Lead-in/Border-in shall be changed to reflect the expanded session. The number of sessions and tracks does not change after this operation.

6.5.4.2.7 Format Type = 12h (CD/DVD-RW Add Session)

Formatting to add a new session to a CD/DVD-RW media is specified. The Number of Blocks field specifies the number of addressable blocks for the new session and the Type Dependent Parameter field specifies the Fixed Packet Size for CD or is set to ECC block size (16) for DVD-RW. The Number of Blocks field may be adjusted to a value less than or equal to the values reported by the READ FORMAT CAPACITIES Command (6.24).

The Drive shall round the Number of Blocks up to be an integral multiple of the packet size for CD or the ECC block size for DVD. The Packet Size field shall not be adjusted. On CD media, if a different Fixed Packet Size is desired, the Host should modify the Write Parameters Page.

On DVD-RW media, this format operation is available only when a disc is in restricted overwrite mode and the last session is in a complete state. Start PSN of the next Border-in field in the previous Border-in/Lead-in shall be updated.

6.5.4.2.8 Format Type = 13h (DVD-RW Quick Grow the last Session)

Formatting to expand the last session and enter the last session into intermediate state of a DVD-RW medium is specified. The Number of Blocks field specifies the number of addressable blocks to be added to current session capacity and the Type Dependent Parameter field is set to ECC block size (16). The Drive shall round the Number of Blocks up to be an integral multiple of the ECC block size.

This format operation is available only when the disc is in restricted overwrite mode and the last session is complete state. Growing of session operation shall start from the next sector of End Sector Number of Track #n field that is corresponded to the last track.

The number of sessions and tracks does not change after this operation. The Disc Status field of Format 3 RMD shall be set to 13h when the operation is completed. End PSN of Data Area field in Lead-in/Border-in of the last session shall be set to 30000h. And Start PSN of the current Border-out and Start PSN of the next Border-in field in Lead-in/Border-in of the last session shall be set to 00h.

6.5.4.2.9 Format Type = 14h (DVD-RW Quick Add Session)

Formatting to add a new intermediate state session to an existing session on DVD-RW media is specified. At least one or more sessions shall exist on a medium and the last session shall not be intermediate state before start this operation.

The area from the beginning of Border-in that follows the last Border-out, user data blocks and 32 ECC blocks with Lead-out attribute is recorded. Start PSN of the next Border-in field in the previous Border-in/Lead-in shall not be changed to reflect the intermediate state session that is added.

If FORMAT UNIT command with this Format Type is issued when the last session is already intermediate state, the command shall be terminated with CHECK CONDITION status and SK/ASC/ASCQ values shall be set to ILLEGAL REQUEST/INVALID FIELD IN PARAMETER LIST.

The Number of Blocks field specifies the number of addressable blocks for the new session and the Type Dependent Parameter field is set to ECC block size (16). The Number of Blocks field may be adjusted to a value less than or equal to the values reported by the READ FORMAT CAPACITIES command. The Drive shall round the Number of Blocks up to be an integral multiple of the ECC block size.

6.5.4.2.10 Format Type = 15h (DVD-RW Quick)

Formatting to create an Intermediate State session on DVD-RW media is specified. The created session shall become the only session on the medium. The Number of Blocks field specifies the number of addressable blocks for the new session and the Type Dependent Parameter field is set to ECC block size (16). The Number of Blocks field may be adjusted to a value less than or equal to the values reported by the READ FORMAT CAPACITIES command. The Drive shall round the Number of Blocks up to be an integral multiple of the ECC block size for DVD.

This format operation is always available. If a disc is to be formatted that is blanked, new intermediate state session is created at the beginning of the disc and the recording mode is changed to restricted overwrite mode. The number of track in the created session is one after this operation. The Disc Status field of Format 3 RMD shall be set to 13h when the operation is completed.

6.5.4.2.11 Format Type = 16h (HD DVD-R Expand Test Zone)

In order to keep more space as Test Zone, this formatting is used. Eventually the capacity of the Data Area is reduced. The FOV, DPRO, DCRT, STPF, IP, Try-out and VS bit shall be set to 0. The Number of Blocks field and the Type Dependent Parameter field shall be ignored.

The Test Zone **may** be extended only once. Attempting to extend the Test Zone when the Test Zone is already extended, the command shall be terminated with CHECK CONDITION status and sense bytes SK/ASC/ASCQ shall be set to ILLEGAL REQUEST/NO MORE TEST ZONE EXTENSIONS ARE ALLOWED.

This Format Type is used for extending Test zone in HD DVD-R media. Then this Format descriptor shall not be returned by READ FORMAT CAPACITIES command.

6.5.4.2.12 Format Type = 20h (Full Format with sparing parameters)

This Format Type is defined for DVD-RAM and HD DVD-RAM media.

The Number of Blocks field specifies the maximum number of addressable blocks for the whole disc. The Type Dependent Parameter is shown in Table 252. M specifies SL where $SL = 2^M$, $4 \leq M \leq 15$ or $SL = 0$ if $M = 0$ and N identifies SI where $SI = 2^N$, $4 \leq N \leq 24$.

Table 252 — Type Dependent Parameter for Format Type 20h

Bit Byte	7	6	5	4	3	2	1	0
5	Integer M such that $M = 0$ or $4 \leq M \leq 15$							
6	Reserved							
7	Integer N such that							

The drive shall verify that SL and SI are usable values (will not cause overflow of the SDL).

6.5.4.2.13 Format Type = 24h, (MRW Full Format)

If the currently mounted medium is neither CD-RW nor DVD+RW, the command shall be terminated with CHECK CONDITION status and set SK/ASC/ASCQ values to ILLEGAL REQUEST/INVALID FIELD IN PARAMETER LIST.

If the currently mounted media is CD-RW and a new format is requested, the Number of Blocks parameter shall have the value FFFFFFFFh. If the field contains any other value, the Drive shall terminate the command with CHECK CONDITION status and set SK/ASC/ASCQ values to ILLEGAL REQUEST/INVALID FIELD IN PARAMETER LIST.

If the currently mounted media is 8 cm DVD+RW and a new format is requested, the Number of Blocks parameter shall have the value FFFFFFFFh. If the field contains any other value, the Drive shall terminate the command with CHECK CONDITION status and set SK/ASC/ASCQ values to ILLEGAL REQUEST/INVALID FIELD IN PARAMETER LIST. Spare area 1 shall be 4 096 sectors in length while spare area 2 shall be 61 440 sectors in length. Sparing represents approximately 10% of the primary user data space.

If the currently mounted media is 12 cm DVD+RW and a new format is requested, the Number of Blocks parameter shall have either the value FFFFFFFFh or FFFF0000h. If the field contains any other value, the Drive shall terminate the command with CHECK CONDITION status and set SK/ASC/ASCQ values to ILLEGAL REQUEST, INVALID FIELD IN PARAMETER LIST. Spare area 1 is always 4 096 sectors in length. When the Number of Blocks value is FFFFFFFFh, spare area 2 is 61 440 in length. In this case, sparing represents approximately 3% of the primary user data space. When the Number of Blocks value is FFFF0000h, spare area 2 is 258 048 in length. In this case, sparing represents approximately 12.8% of the primary user data space.

Formatting operates in background for Format Type 24h. The Host may suspend a format in progress and may restart the format.

The Type Dependent Parameter has the meaning of "New format" when it has the value 000000h. The Type Dependent Parameter has the meaning of "Restart format" when it has the value 000001h. When Restart format is selected, the Number of Blocks field has no meaning and shall be ignored. If the field contains any other value, the Drive shall terminate the command with CHECK CONDITION status and set SK/ASC/ASCQ values to ILLEGAL REQUEST/INVALID FIELD IN PARAMETER LIST.

Certification of the format is based upon current medium status as shown in Table 253.

Table 253 — Use of DCRT when MRW Formatting

Current Disc Status	DCRT = 0	DCRT = 1
Physically Blank	Write entire surface format, verify MRW structures and user areas	Write entire surface format, verify only MRW structures
Written, but not MRW Formatted (includes logically blank)	Write format, verify MRW structures and user areas. In this case, the CD-MRW Defect Management & Physical Formatting Specification and the DVD+MRW Defect Management & Physical Formatting Specification require certification of the user area.	
MRW formatted	Reinitialize MRW structures, verify MRW structures and user areas. In this case, the CD-MRW Defect Management & Physical Formatting Specification and the DVD+MRW Defect Management & Physical Formatting Specification require certification of the user area.	

In all cases when:

- DCRT is set to zero,
- the Host requests to WRITE the sector at LBA = N, and
- sector N has not yet been verified by the format operation,.

The WRITE command shall be treated as a WRITE and VERIFY command.

6.5.4.2.14 Format Type = 26h, (DVD+RW Basic Format)

If the currently mounted medium is not DVD+RW, the command shall be terminated with CHECK CONDITION status and set SK/ASC/ASCQ values to ILLEGAL REQUEST/INVALID FIELD IN PARAMETER LIST.

The Number of Blocks field shall be set to either the value returned by the READ FORMAT CAPACITIES command or FFFFFFFFh. The Drive shall accept either value. If the Host sends any other value, then the Drive shall terminate the command with CHECK CONDITION status and set SK/ASC/ASCQ values to ILLEGAL REQUEST/ILLEGAL VALUE IN PARAMETER BLOCK. Implementation of background format is mandatory.

Formatting operates in background for Format Type 26h. The Host may suspend a format in progress and may restart the format.

The Type Dependent Parameter is shown in Table 254.

Table 254 — Type Dependent Parameter for Format Type 26h

Bit Byte	7	6	5	4	3	2	1	0
5	Reserved							
6	Reserved							
7	Reserved						Quick Start	Restart

When Quick Start is zero, the format operation shall initialize the lead-in according to [DVD+Ref2], prior to declaring the format command complete. When Quick Start is one, the format operation shall not initialize the entire lead-in prior to sending GOOD status for the format command. The amount of the lead-in initialized by Quick Start formatting is vendor specific.

When Restart is set to zero, the Drive shall perform a new format.

When Restart is set to one, the DVD+RW Drive shall continue a suspended background format. All other fields in the Type Dependent Parameter shall be ignored. If there is no suspended background format to continue, the DVD+RW Drive shall terminate the command with CHECK CONDITION status and set sense data to ILLEGAL REQUEST, COMMAND SEQUENCE ERROR.

DCRT has no meaning when formatting type 26h. The device ignores DCRT.

6.5.4.2.15 Format Type = 30h (Format BD-RE with Spare Areas)

Format Sub-type (Table 255) selects a sub-type of Format Type 30h that is independent of the setting of the DCRT bit in the Format List Header.

Table 255 — Format Sub-type Field

Sub-type Value	Description
00b	Quick Reformat: If the disc is blank, the format process shall simply initialize the disc structures with no certification. If the disc has been previously formatted, a Quick Reformat shall be performed. Quick Reformat consists of declaring that all Clusters marked as defective in the DFL become marked as possibly bad during the reformat. Assigned spares are released.
01b	No Certification: No certification shall be applied to the data area after disc structures have been initialized. The defect tables shall be initialized to indicate no media defects.
10b	Full Certification: The entire data area shall be certified. The defect tables shall be initialized with defects discovered during the certification process.
11b	Quick Certification: If the media has been previously formatted, the defect tables shall be reconstructed by certifying only the Clusters that were previously declared to be defective.

Format Type 30h requires that the Drive format the disc in order that the User Data Zone contains at least Number of Blocks. The number of spare Clusters allocated shall be less than or equal to:

$S = IP[(Data\ Zone\ Size - Number\ of\ Blocks)/32]$, where IP is the integer part of the result.

Allocation rules for spare areas differ for disc size (i.e. 80mm or 120mm) and number of layers as shown in Table 256.

Table 256 — Maximum Spare Area Sizes on BD-RE

Disc Spare Area	80 mm Single Layer	80 mm Dual Layer	120 mm Single Layer	120 mm Dual Layer
ISA0 ¹	4096	4096	4096	4096
OSA0 ²	0	0	16384	8192
OSA1 ²	-	0	-	8192
ISA1 ²	-	16384	-	16384
Totals	4096	20480	20480	36864

¹The size of ISA0 is fixed at 4096 Clusters, regardless of size of number of layers.
²The spare area must be allocated in increments of 256 Clusters.

Since the formatted capacity of the media may be larger than the Number of Blocks field, when formatting has completed, the Host should send the READ CAPACITY command in order to determine the actual capacity.

Sub-type identifies certification to be performed as described in Table 258. The Spare Area size in Clusters field is ignored by the Drive.

6.5.4.2.15.1 Spares Allocation on 80mm Single Layer BD-RE

S shall be at least 4096. If S is less than 4096, then the command shall be terminated with CHECK CONDITION status and sense bytes SK/ASC/ASCQ shall be set to ILLEGAL REQUEST/INVALID FIELD IN PARAMETER LIST.

6.5.4.2.15.2 Spares Allocation on 80mm Dual Layer BD-RE

S shall be at least 4096. If S is less than 4096, then the command shall be terminated with CHECK CONDITION status and sense bytes SK/ASC/ASCQ shall be set to ILLEGAL REQUEST/INVALID FIELD IN PARAMETER LIST.

If $S > 4096$, then set $S_1 = \text{MIN}(256 * IP[(S - 4096)/256], 16384)$. ISA1 shall be allocated S_1 spare Clusters.

6.5.4.2.15.3 Spares Allocation on 120mm Single Layer BD-RE

S shall be at least 4096. If S is less than 4096, then the command shall be terminated with CHECK CONDITION status and sense bytes SK/ASC/ASCQ shall be set to ILLEGAL REQUEST/INVALID FIELD IN PARAMETER LIST.

If $S > 4096$, then set $S_1 = \text{MIN}(256 * IP[(S - 4096)/256], 16384)$. OSA0 shall be allocated S_1 spare Clusters.

6.5.4.2.15.4 Spares Allocation on 120mm Dual Layer BD-RE

S shall be at least 4096. If S is less than 4096, then the command shall be terminated with CHECK CONDITION status and sense bytes SK/ASC/ASCQ shall be set to ILLEGAL REQUEST/INVALID FIELD IN PARAMETER LIST.

ISA0 shall be allocated 4096 Clusters.

Due to the fixed size of ISA0, it is preferred to allocate OSA0, OSA1, and ISA1 such that the size of ISA1 is at least twice the size of OSA0. Thus, when $S > 4096$, the preferred allocations for ISA1, OSA0, and OSA1 are given by the following:

$$SizeofOSA0 = SizeofOSA1 = 256 * IP\left(\frac{S - 4096}{4 * 256}\right)$$

and

$$SizeofISA1 = 256 * IP\left(\frac{S - 4096}{256}\right) - 2 * SizeofOSA0$$

6.5.4.2.16 Format Type = 31h (Format BD-RE without Spare Areas)

If the RENoSA bit is set to one in the Formattable Feature descriptor, Format Type 31h is supported. Format Type 31h specifies the drive to execute the formatting process with no Spare Area.

The User Data Zone size specifies the total number of user accessible blocks on all layers of the disc. The recommended value of this field for the mounted disc is obtained by READ FORMAT CAPACITIES command. The value of User Data Zone size field shall be less than or equal to the Number of Blocks field value in the Formattable Capacity Descriptor for the minimum Spare Area size, and shall be greater than or equal to the Number of Blocks field value in the Formattable Capacity Descriptor for the maximum Spare Area size.

Format Sub-type identifies certification to be performed as described in Table 255.

The Type Dependent Parameter specifies the Block Length in bytes.

6.5.4.2.17 Format Type = 32h (Format BD-R with Spare Areas)**6.5.4.2.18 Overview**

Format Type 32h permits formatting a BD-R disc in SRM+POW, SRM-POW, or RRM. When formatted with Format Type 32h, the BD-R disc is required to allocate a non-zero number of spares.

Table 257 shows the Type Dependent Parameter for Format Type 32h.

Table 257 — Type Dependent Parameter for Format Type = 32h

Bit Byte	7	6	5	4	3	2	1	0
5	ISA_V	Reserved			Spare Area Distribution Parameter			
6	TDMA_V	Reserved			TDMA Distribution Parameter			
7	Reserved							

Number of Blocks contains the minimum number of LBAs that shall be formatted on the disc.

Format Sub-type selects a sub-type of format Type 32h.

Table 258 — Format Sub-type Field

Sub-type Value	Description
00b	SRM+POW
01b	SRM-POW
10b	RRM
11b	Reserved

If ISA_V is set to one, the Spare Area Distribution Parameter is valid. If ISA_V is set to zero, a vendor specific default shall be assigned for the numeric value of the Spare Area Distribution Parameter.

The Drive shall interpret Spare Area Distribution Parameter as the integer between 1 and 15 that most nearly satisfies:

$$\frac{\text{SpareAreaDistributionParameter}}{16} = \frac{\text{ISA0size} + \text{ISA1size}}{\text{TotalSAsize}} = \frac{4096 + \text{ISA1size}}{S}$$

If TDMA_V is set to one, the TDMA Distribution Parameter is valid.

If TDMA_V is set to zero, a vendor specific default shall be assigned for the numeric value of the TDMA Distribution Parameter.

The Drive shall interpret TDMA Distribution Parameter as the nearest integer that satisfies:

$$\frac{\text{TDMADistributionParameter}}{16} = \frac{\text{TDMAsize}}{\text{TotalSAsize}}$$

Consequently,

$$\text{TDMAsize} = \text{TotalSAsize} * \frac{\text{TDMADistributionParameter}}{16}$$

6.5.4.2.19 Calculating Spare Size

Allocation rules for spare areas differ for disc size (i.e. 80mm or 120mm) and number of layers as shown in Table 259.

Table 259 — Maximum Spare Area Sizes on BD-R

Disc Spare Area	80 mm Single Layer	80 mm Dual Layer	120 mm Single Layer	120 mm Dual Layer
ISA0 ¹	4 096	4 096	4 096	4 096
OSA0 ²	65 536	65 536	196 608	196 608
OSA1 ²	-	65 536	-	196 608
ISA1 ²	-	16 384	-	16 384
Max Possible Allocatable Spares	69 632	151 552	200 704	413 696

¹The size of ISA0 is fixed at 4096 Clusters, regardless of size of number of layers.
²The spare area must be allocated in increments of 256 Clusters.

Format Type 32h requires that the Drive format the disc in order that the User Data Zone contains at least Number of Blocks. The number of spare Clusters allocated shall be at most:

$$S = 256 * IP \left(\frac{DataZoneSize - NumberOfBlocks}{256 * 32} \right)$$

where IP is the integer part of the result.

S is a count of Clusters that is an integral multiple of 256.

S shall be at least 4096. If S is less than 4096, then the command shall be terminated with CHECK CONDITION status and sense bytes SK/ASC/ASCQ shall be set to ILLEGAL REQUEST/INVALID FIELD IN PARAMETER LIST.

If the disc is single layer and $S > 4096$, then

$$ISA0size = 4096$$

and

$$OSA0size = MIN[MaxOSA0size, S - 4096].$$

If the disc is dual layer and $S > 4096$, then

$$ISA0size = 4096,$$

$$ISA1size = MIN \left[MaxISA1size, 256 * IP \left(\frac{S * SADP}{16} - 4096 \right) \right],$$

and

$$OSA0size = OSA1size = MIN \left[MaxOSA0size, 256 * IP \left(\frac{S - 4096 - ISA1size}{2 * 256} \right) \right].$$

6.5.4.2.20 Calculating Additional TDMA Space

Spare area sizes must be determined prior to calculating the TDMA allocations.

Inner Zone TDMA's has a fixed size of 2048 Clusters each. Additional TDMA space is taken from the spare areas. The amount of each spare area that is allocated for TDMA is determined by the TDMA Distribution Parameter.

When the BD-R disc is single layer:

$$TDMA0size = 2048,$$

$$TDMA1Size = 256 * IP \left(\frac{4096 * TDMADistributionParameter}{16 * 256} \right), \text{ and}$$

$$TDMA2Size = 256 * IP \left(\frac{OSA0size * TDMADistributionParameter}{16 * 256} \right).$$

When the BD-R disc is dual layer:

$$TDMA0size = 2048,$$

$$TDMA1size = 2048,$$

$$TDMA2Size = 256 * IP \left(\frac{4096 * TDMADistributionParameter}{16 * 256} \right),$$

$$TDMA3Size = TDMA4size = 256 * IP \left(\frac{OSA0size * TDMADistributionParameter}{16 * 256} \right), \text{ and}$$

$$TDMA5Size = 256 * IP \left(\frac{ISA1size * TDMADistributionParameter}{16 * 256} \right)$$

6.5.4.3 Use of the IMMED Bit

If the IMMED bit is set to zero, the Drive shall format the entire media according to the Format Unit Parameter List and shall not terminate the command until completed. This is undesirable when the Host/Device interface has limited or no disconnect/reselect capability.

If the IMMED bit is set to one, the Drive shall verify that execution of the Format Unit command may begin without error and then terminate the command with GOOD status.

During a format operation that began with the IMMED bit set to one, the Drive shall respond to commands as follows:

- In response to all commands except REQUEST SENSE, INQUIRY, GET CONFIGURATION, and GET EVENT STATUS NOTIFICATION, the Drive shall return CHECK CONDITION status and set SK/ASC/ASCQ to NOT READY/LOGICAL UNIT NOT READY/FORMAT IN PROGRESS. If the Drive changes ready state, an Operational Change Event shall be generated. If appropriate, other events may be generated (e.g. Media Events).
- In response to the INQUIRY, GET CONFIGURATION, GET EVENT STATUS NOTIFICATION commands, the Drive shall respond as commanded.

In response to the REQUEST SENSE command, unless an error has occurred, the Drive shall return a SK/ASC/ASCQ values set to NOT READY/LOGICAL UNIT NOT READY/FORMAT IN PROGRESS, with the sense key specific bytes set for progress indication (Table 260). The normative description is found in [SPC-3]. SKSV shall be set to one and the Progress Indication field shall contain 16 bit unsigned value such that (Progress Indication)/65 536 X 100% approximates the percentage of completion of the operation. Once the operation is completed, SKSV shall be set to zero.

Table 260 — Sense Key Specific Bytes in Sense Data

Bit	7	6	5	4	3	2	1	0	
Byte									
15	SKSV	Reserved							
16	(MSB)	Progress							
17		Indication							(LSB)

6.5.4.4 Background Formatting

6.5.4.4.1 Overview

Background formatting is defined for MRW (Format Type 24h) and DVD+RW (Format Type 26h). Background Formatting is divided into 2 processes: the foreground format process, and the background format process. The foreground format process is performed first. Once the foreground process has completed, the background format process begins. Of total format time required, the foreground format process should represent a very small part, while the background format process represents a significantly larger part.

Once the background format process has begun, the Host may request a suspension of the format operation for the purpose of media removal. If a suspension is requested, the Drive shall write to the media in such a way that the format state and level of completion may be identified for the purpose of continuing the background format process.

During the term of the background format, its state (Completed (3), Not Complete and running (2), Not complete and not running (1)) shall be reported in the returned data of the READ DISC INFORMATION command. See 6.22.3.14.

6.5.4.4.2 The Foreground Part of the Format Process

During the foreground format process, basic media structures shall be minimally initialized such that the media Format State may be identified. Relative to the Host, the operation is no different from other formatting. The foreground format process is completed when:

1. The specific format type is identifiable based upon written media structures.
2. Format restart information indicates that a suspended background format may be continued with an indication that zero amount of the background format process has been performed.

If the IMMED bit is set to zero, then once the foreground format process has completed, the command shall be terminated with GOOD status.

If the IMMED bit is set to one, the Format Unit Command should be terminated with GOOD status once the CDB and parameter list have been validated.

6.5.4.4.3 The Background Format Process

Once the foreground part of the formatting has completed, the Drive shall continue the format in background. It is at this point that BG format status in the READ DISC INFORMATION returned data becomes non-zero. If the formatting had begun with IMMED = 0, the Format Unit Command shall terminated with GOOD status. At this point, the media is viewed as "write accessible". If any media accessing command is issued before this time, the Drive shall terminate the command with CHECK CONDITION status and set sense bytes SK/ASC/ASCQ to NOT READY/LOGICAL UNIT NOT READY/FORMAT IN PROGRESS.

Regardless of the setting of IMMED, once the disc has become write accessible, and there are no pending errors, sense bytes SK/ASC/ASCQ shall be set to NO SENSE/FORMAT IN PROGRESS and the sense key specific bytes (Table 260) shall be set as a progress indicator.

Warning to Implementers:

Drive panel indicators (e.g. LEDs) may normally indicate writing. Implementers should choose to modify this behavior during background formatting in order to avoid confusing the user.

6.5.4.4.4 Stopping and Restarting Background Format

If a format is executing in background:

- a) The CLOSE TRACK/SESSION Command shall be used to stop the formatting process. See 6.3 for details.

- b) The inactivity timer (CD-ROM Mode Page) is disabled. This insures that lack of Host activity does not allow a spin down during background formatting.
- c) If the Host sends a SCSI command that requires that the medium spin down, the Drive shall terminate the command with CHECK CONDITION status and set sense data to NOT READY, LOGICAL UNIT NOT READY, FORMAT IN PROGRESS. Examples: START/STOP UNIT command is issued with Start = 0, START/STOP UNIT command with power controls that require a spin-down.
- d) If the Host/Drive physical interface provides a command layer with commands that may cause the medium to spin down, then those commands shall be terminated with the appropriate error status. e.g. if the interface is ATA and the command is EXECUTE DIAGNOSTICS, IDLE or SLEEP, then the command shall be terminated with the status register ERROR bit set to true.
- e) If any other command is issued to the Drive, it shall be processed normally.

The format process may be restarted with a FORMAT UNIT Command in which the format descriptor is sent with the type dependent parameter set to 000001h. If the format has been completed, restarting the background format function shall not be considered an error. The command shall terminate with GOOD status and the BGformatCompleted event shall be posted.

The Drive may also restart the format process automatically. If a write is requested at an address within the final media capacity and beyond the current user formatted space, the background format shall be restarted using parameters saved on the media. The BgformatRestarted Media Event shall be posted. The format state shall be changed to "Not Complete and Running", and the write shall proceed accordingly.

6.5.4.4.5 Writing During the Background Format Process

Writing to the media during different format states sometimes requires different action by the Drive. The cases are shown in Table 261.

Table 261 — Writing During different Format States

State of Format	Write Range	Action By Drive
Completed	All valid user space addresses	The Host's data is written as provided.
Not Complete and running	All valid user space addresses	The Host's data is written as provided. Format state shall not be changed.
Not complete, not running	Valid user space addresses in formatted region	The Host's data is written as provided. Format state shall not be changed.
	Valid user space addresses beyond formatted region. This includes relocations into a spare area beyond the temporary STA. The implementer should be aware that relocations may occur during read when ARRE is set to one in the READ/WRITE ERROR RECOVERY MODE PAGE.	The background format shall be restarted using parameters saved on the media. The BgformatRestarted Media Event shall be posted. The format state is now "Not Complete and Running", so the write shall proceed accordingly.

6.5.4.4.6 Recovering an Incomplete Format

The background format may be stopped in a controlled way as described in 6.5.4.4.4, above. An interface level RESET or loss of power may also stop a background format operation, but not in a controlled way. This may produce a disc that is partially formatted, however, it may also contain recoverable data. The format may not be recoverable, however, user data should be recoverable. After a catastrophic power loss, some use data may be lost.

A Host operated recovery application may be produced in order to recover data from the disc. Refer to the appropriate physical format documents.

6.5.5 Timeouts

The FORMAT UNIT command belongs to timeout group 2 when IMMED is zero. The group 2 timeout value is only for Host information. The Drive shall not time group 2 timeout commands. Execution shall continue until completion.

When the IMMED is set to one, status shall be returned within a Group 1 timeout.

6.5.6 Error Reporting

When the command operation began with the CDB IMMED bit set to one, it is possible that a deferred error may be reported in some future command. Recommended error reporting is defined in Table 262.

Table 262 — Recommended Errors for the FORMAT UNIT Command.

Error	Reference	May be Deferred
Unit Attention conditions	Table F.1	
CDB or parameter list validation errors	Table F.2	
Readiness errors	Table F.3	
Protocol errors	Table F.4	
General media access errors	Table F.5	√
Write errors	Table F.7	√
Hardware failures	Table F.8	√

6.6 GET CONFIGURATION Command

The GET CONFIGURATION command provides a Host with information about Drive capabilities; both current and potential. The command shall not return a CHECK CONDITION Status due to a pending UNIT ATTENTION Condition. Any pending UNIT ATTENTION Condition shall not be cleared for the Drive issuing the GET CONFIGURATION Command.

Features that specify implementation of the GET CONFIGURATION command are listed in Table 263.

Table 263 — Features Associated with the GET CONFIGURATION Command

Feature Number	Feature Name	Command Requirement
0001h	Core	Mandatory
0002h	Morphing	Mandatory

6.6.1 The CDB and its Parameters

6.6.1.1 The CDB

The Get Configuration CDB is shown in Table 264.

Table 264 — GET CONFIGURATION CDB

Bit	7	6	5	4	3	2	1	0
Byte								
0	OPERATION CODE (46h)							
1	Reserved						RT	
2	(MSB) Starting Feature Number (LSB)							
3								
4	Reserved							
5	Reserved							
6	Reserved							
7	(MSB) Allocation Length (LSB)							
8								
9	Control							

6.6.1.2 RT

The RT field identifies the type of data to be returned by the Drive. The possibilities and meanings for the RT field are listed in Table 265.

Table 265 — RT Field Definitions

RT value	Definition
00b	The Drive shall return the Feature Header and all Feature Descriptors supported by the Drive without regard to currency.
01b	The Drive shall return the Feature Header and only those Feature Descriptors in which the Current bit is set to one.
10b	The Feature Header and the Feature Descriptor identified by Starting Feature Number shall be returned. If the Drive does not support the specified feature, only the Feature Header shall be returned.
11b	Reserved

6.6.1.3 Starting Feature Number

The Starting Feature Number field indicates the first Feature number to be returned. All supported Feature numbers higher than the Starting Feature Number shall be returned.

6.6.1.4 Allocation Length

The Allocation Length field specifies the maximum length in bytes of the Get Configuration response data. An Allocation Length field of zero indicates that no data shall be transferred. This condition shall not be considered an error.

6.6.2 Command Processing

6.6.2.1 GET CONFIGURATION Response Data

The GET CONFIGURATION response Data (Table 266) consists of a header field and zero or more variable length feature descriptors.

Table 266 — GET CONFIGURATION response data format

Bit Byte	7	6	5	4	3	2	1	0
0 – 7	Feature Header							
8 – n	Feature Descriptor(s)							

The Feature Header field to be returned is shown in Table 267.

Table 267 — Feature Header

Bit Byte	7	6	5	4	3	2	1	0
0	(MSB) Data Length (LSB)							
1								
2								
3								
4	Reserved							
5	Reserved							
6	(MSB) Current Profile (LSB)							
7								

The Data Length field indicates the amount of data available given a sufficient allocation length following this field. This length shall not be truncated due to an insufficient Allocation Length. If the Data Length is greater than 65 530 bytes, multiple GET CONFIGURATION commands with different Starting Feature Numbers are required for the Host to read all configuration data. This field is adjusted as appropriate for the given Starting Feature Number.

The maximum number of definable Features is 65,536. The maximum number of bytes that a Drive may return to describe its Features in one Command is 65,534. Feature lists longer than 65,534 bytes require multiple Commands.

Note 10. In this standard, the entire set of defined feature descriptors amounts to less than 1 KB.

The Current Profile field shall indicate the Drive's current Profile. The Drive shall select the current Profile from the list of Profiles (see Table 87) with their CurrentP bit set. If more than one Profile is current, the largest Profile number is used. If no Profile is currently active, this field shall contain zero.

6.6.2.2 Features

Features are the smallest set of commands, pages, and behavior that may be implemented. A list of defined features is shown in Table 84.

The Feature Descriptor(s) generic format returned is defined in Table 83. Each individual Feature description is defined in the appropriate sub-clause.

6.6.2.3 Profile List

This Feature identifies Profiles supported by the Drive. Profiles are defined as collections of Features and provide a method to quickly determine the Drive's type. This Feature is always current, even if none of the Profiles listed is current.

The Profile Descriptor format is shown in Table 86. All Profiles supported by the Drive shall always be reported. The Profile Number identifies a Profile to which the Drive conforms. See 5.4. Profile descriptors are returned in descending numerical order.

6.6.3 Timeouts

Command Processing timeouts as specified by the Timeout Feature do not apply to the GET CONFIGURATION command.

6.6.4 Error Reporting

Recommended error reporting is defined in Table 268.

Table 268 — Recommended Errors for the GET CONFIGURATION Command

Error	Reference
CDB or parameter list validation errors	

6.7 GET EVENT STATUS NOTIFICATION Command

The GET EVENT STATUS NOTIFICATION command requests that the Drive report events and statuses according to a Notification Class as a method of asynchronous notification. Two modes of operation are defined: polling and asynchronous.

Features that specify implementation of the GET EVENT STATUS NOTIFICATION command are listed in Table 269.

Table 269 — Features Associated with the GET EVENT STATUS NOTIFICATION Command

Feature Number	Feature Name	Command Requirement
0001h	Core	Mandatory
0002h	Morphing	Mandatory

6.7.1 The CDB and its Parameters

6.7.1.1 The CDB

The GET EVENT STATUS NOTIFICATION CDB is shown in Table 270.

Table 270 — GET EVENT STATUS NOTIFICATION CDB

Bit	7	6	5	4	3	2	1	0	
0	Operation Code (4Ah)								
1	Reserved							Polled	
2	Reserved								
3	Reserved								
4	Notification Class Request								
5	Reserved								
6	Reserved								
7	(MSB)	Allocation Length							
8								(LSB)	
9	Control								

6.7.1.2 Polled

The Polled bit is used to select operational mode. When Polled is set to zero, the Host is requesting asynchronous operation. If the Drive does not support asynchronous operation, the command shall be terminated with CHECK CONDITION status and the values for SK/ASC/ASCQ shall be set to ILLEGAL REQUEST/INVALID FIELD IN CDB.

Note 11. If Polled is zero while a Group 2 timeout command is executing, the GET EVENT STATUS NOTIFICATION command may be queued, but it never terminates.

When Polled is set to one, the Host is requesting polled operation. The Drive shall return event information for the highest priority requested event. If no event has occurred, the Drive shall report the “No Change” event for the highest priority requested event class.

6.7.1.3 Notification Class Request

Notification Class Request field specifies that the Drive report event(s) from the event classes requested in this field. Table 271 defines the codes listed in this field.

Table 271 — Notification Class Request field definition

Bit	Definition
0	Reserved
1	Operational Change
2	Power Management
3	External Request
4	Media
5	Multi-Host
6	Device Busy
7	Reserved

Lowest class number has highest priority.

Bit 7 is reserved for future standardization and shall be treated as unsupported event class. Bit 0 is perpetually reserved. If either of these bits is set to one, it shall not be considered an error.

A Notification Class Request field of zero shall not be considered an error.

6.7.1.4 Allocation Length

The Allocation Length field indicates the maximum number of bytes that shall be transferred from the Drive. If Allocation Length is 4 or less, then the Drive shall transfer Event Header only and shall not clear any event. An event shall be considered reported for all Allocation Lengths greater than 4. An Allocation Length of zero shall not be considered an error.

Note 12. The Host should set Allocation Length field to 8 or greater in order to retrieve Event Data correctly.

6.7.2 Command Processing

6.7.2.1 General

When polling, the Host should issue GET EVENT STATUS NOTIFICATION commands at periodic intervals. The Drive shall complete this command with the most recently available event status requested. The Drive shall support polling mode.

Asynchronous operation requires a transport that provides command queueing and disconnect. The Host should issue a single GET EVENT STATUS NOTIFICATION command. The Drive shall process the command and return requested event information only when some requested event has occurred.

Only one event class per GET EVENT STATUS NOTIFICATION command shall be reported. The priority of event reporting shall be by Event Class number where lowest Classes are higher priority.

This command shall not return CHECK CONDITION status to report a unit attention condition. Any pending unit attention condition for which a corresponding event is reported shall not be cleared for the Drive.

6.7.2.2 Event Status Notification Data

The Event Status Notification Response (Table 272) is a 4-byte header followed by an Event Descriptor associated with exactly one event class.

Table 272 — Event Status Notification Response

Bit	7	6	5	4	3	2	1	0
Byte								

0 – 3	Event Header
4 – n	Event Descriptor

The Event Header content defined in Table 273.

Table 273 — Event Header

Bit Byte	7	6	5	4	3	2	1	0
0	(MSB) Event Descriptor Length							
1	(LSB)							
2	NEA	Reserved				Notification Class		
3	Supported Event Class							

The Event Descriptor Length field specifies the number of bytes of data that follows the Event Status Notification Header.

If NEA (No Event Available) is set to one, the Drive supports none of the requested notification classes. If NEA is set to zero, at least one of the requested notification classes is supported.

The Notification Class field specifies the class of notification as defined in Table 274. If NEA is set to one, this field shall contain 000b.

Table 274 — Notification Class Field Values

Field	Description
000b	No requested Event Classes are supported
001b	Operational Change Request/Notification
010b	Power Management
011b	External Request
100b	Media
101b	Multiple Hosts
110b	Device Busy
111b	Reserved

Supported Event Classes field specifies the event classes that the Drive supports. If an Event Class is supported, the bit corresponding to the Event Class identified in Table 271 is set to one.

The general format of the Event Descriptor is shown in Table 275.

Table 275 — General Event Descriptor Format

Bit Byte	7	6	5	4	3	2	1	0
0	Reserved				Event Code			
1 – N	Specific Event Information							

When Event Code is zero, no change has occurred. Non-zero values for Event Code are Event specific.

Upon reporting an event to the Host, this field is reported as 0h on subsequent GET EVENT STATUS NOTIFICATION commands until a new event of the same class occurs.

6.7.2.3 Operational Change Events

When the Notification Class code in the Event Header is 001b, an Operational Change Event Descriptor (Table 276) follows the header.

An Operational Change event indicates that the operational capabilities or parameters may have changed for this Drive.

Table 276 — Operational Change Event Descriptor

Bit	7	6	5	4	3	2	1	0
Byte								
0	Reserved				Event Code			
1	Persistent Prevented	Reserved			Operational Status			
2	(MSB) Operational Change							(LSB)
3								

Persistent Prevented bit reports the current state of the persistent prevent for the Drive. See 5.3.4.

The Event Code (Table 277) identifies the operational change. Some Event codes present in earlier standards are reserved in this standard. Those codes are Legacy and defined in E.4.

Table 277 — Event Codes For the Operational Change Class

Code	Status	Description
0h	NoChg	No changes in the Drive Operational state
1h	Reserved	-
2h	Drive has changed Operational state	The Drive has changed Operational state
3h – Fh	Reserved	-

If a new Event occurs before an existing Event is reported to the Host, the new event shall replace the old Event if the new Event has a higher Code than the old Event. Otherwise, the new Event shall be deleted.

The Operational Status field is reserved and shall be set to zero (0h) by Drives that comply with this standard. Non-zero values in the Operational Status field are Legacy; see E.4.

The Operational Change field (Table 278) reports the source of the change. If this field contains a non-zero value, the Host should send a GET CONFIGURATION command in order to discover any configuration changes. Some Operational Change field codes present in earlier standards are reserved in this standard. Those codes are Legacy and defined in E.4.

Table 278 — Operational Change

Code	Event	Description
0h	NoChg	No changes in operational state requested or performed
1h	Feature Change	An unspecified event may have changed Feature currency
2h – FFFFh	Reserved	-

6.7.2.4 Power Management Events

When the Notification Class code in the Event Header is 010b, a Power Management Event Descriptor (Table 279) follows the header.

A Power Management Event is reported whenever there is a change to power status. Power changes may occur due to a command from the Host or a timeout as specified in the Timeout and Protect Mode Page (see 7.9).

Table 279 — Power Management Event Descriptor

Bit Byte	7	6	5	4	3	2	1	0
0	Reserved				Event Code			
1	Power Status							
2	Reserved							
3	Reserved							

The Power Event field (Table 280) identifies the power change event.

Table 280 — Power Event Field

Code	Event	Description
0h	NoChg	No changes in power state, or in power state transition
1h	PwrChg-Successful	The Drive successfully changed to the specified power state
2h	PwrChg-Fail	The Drive failed to enter the last requested state, and is still operating at the power state specified in the Power Status field.
3h – Fh	Reserved	

If the Drive is commanded to go the same state that it is currently in, the next GET EVENT STATUS NOTIFICATION (Power Management Class) command shall report a Power Change Successful event.

The Power Status field (Table 281) indicates the current power state of the Drive. The Drive shall be set to Standby (3h) by a Hard reset, a power-on reset or a Device reset (issued from a Sleep state).

Table 281 — Power Status Field

Code	Status	Description
0h	Reserved.	-
1h	Active	The Drive is in Active state
2h	Idle	The Drive is in Idle state
3h	Standby	The Drive is in Standby state
4h	Sleep	The Drive is about to enter Sleep state
5h – Fh	Reserved	-

6.7.2.5 External Request Events

When the Notification Class code in the Event Header is 011b, an External Request Event Descriptor (Table 282) follows the header. The Load/Eject button is not included as an external event.

The External Request Event field reports external requests to change state and notifications of changes in Drive state.

Table 282 — External Request Descriptor

Bit	7	6	5	4	3	2	1	0
Byte								
0	Reserved				Event Code			
1	Persistent Prevented	Reserved			External Request Status			
2	(MSB)				External Request			
3					(LSB)			

The External Request Events are listed in Table 283.

Table 283 — External Request Events

Code	Event	Description
0h	NoChg	No changes in the Drive Operational state performed or requested
1h	Drive Key Down	A front, back, or remote button has been depressed
2h	Drive Key Up	A front, back, or remote button has been released
3h	External Request Notification	The Drive has received a command from another Host that requires an action that may interfere with the Persistent Prevent owner's operation.
4h – Fh	Reserved	-

The Host may respond to Events 1-3 with no action, an appropriate action, or with a SEND EVENT command. If a Persistent Prevent is in place for the Host, the Drive shall not perform the requested action. If a Persistent Prevent is not in place for the Host, the Drive shall notify the Host of actions that change Drive state.

The Host may respond to Event 4 with a GET CONFIGURATION command. Events 1 and 2 should occur in pairs.

The Persistent Prevented bit reports the current state of the persistent prevent for the Drive. This bit shall be set to 1 if any Host has performed a persistent reservation.

The External Request Status field (Table 284) reports the Drive's ability to respond to the Host.

Table 284 — External Request Status Codes

Code	Status	Description
0h	Ready	The Drive is ready for operation
1h	Other Prevent	Indicates that another Host has an active Persistent Prevent. The Persistent Prevented bit shall be set to one.
2h – Fh	Reserved	Reserved

The External Request field (Table 285) reports the operation requested or operation that has been performed. The request usually originates from the unit's own user interface (i.e., front panel buttons) or from another Host.

Table 285 — External Request Codes

Code	Status	Description
0h	No Request	No requests are pending
1h	Overrun	The Request Queue has overflowed, External Request Events may be lost.
2h – 100h	Reserved	
101h	Play	The play button was pressed or another Host requested a play operation.
102h	Rewind/back	The rewind/back button was pressed or another Host requested a rewind/back operation.
103h	Fast Forward	The fast/forward button was pressed or another Host requested a fast/forward operation.
104h	Pause	The pause button was pressed or another Host requested a pause.
105h	Reserved	
106h	Stop	The stop button was pressed or another Host requested a stop.
107h – 1FFh	Reserved	
200h – 2FFh	ASCII Button	A front panel button was pressed or equivalent action requested by another Host. The button has an associated ASCII value. The ASCII value shall be the least significant 8 bits of the Code.
300h – EFFFh	Reserved	
F000h – FFFFh	Vendor Unique	

6.7.2.6 Media Events

When the Notification Class code in the Event Header is 100b, a Media Event Descriptor follows the header.

Table 286 — Media Event Descriptor

Bit Byte	7	6	5	4	3	2	1	0
0	Reserved				Event Code			
1	Media Status							
2	Start Slot							
3	End Slot							

6.7.2.6.1 Event Code

The Media Event field is defined in Table 287.

Table 287 — Media Event Format

Code	Event	Description
0h	NoChg	Media status is unchanged
1h	EjectRequest	The Drive has received a request from the user (usually through a mechanical switch on the Drive) to eject the specified slot or media.
2h	NewMedia	The specified slot (or the Drive) has received new media, and is ready to access it.
3h	MediaRemoval	The media has been removed from the specified slot, and the Drive is unable to access the media without user intervention. This applies to media changers only.
4h	MediaChanged	The user has requested that the media in the specified slot be loaded. This applies to media changers only.
5h	BgformatCompleted	A MRW or DVD+RW background format has completed. Since MRW and DVD+RW Drives are capable of generating multiple media events concurrently, such Drives shall be capable of queuing media events.
6h	BgformatRestarted	A MRW or DVD+RW background format has been automatically restarted by the Drive. Since MRW and DVD+RW Drives are capable of generating multiple media events concurrently, such Drives shall be capable of queuing media events.
7h – Fh	Reserved	

6.7.2.6.2 Media Status

The Media Status byte is defined in Table 288.

Table 288 — Media Status Byte Definition

Bit Byte	7	6	5	4	3	2	1	0
0	Reserved						Media Present	Door or Tray open

If the Media Present bit is set to zero, no media is present in the Drive. If the Media Present bit is set to one, media is present in the Drive.

If the Door or Tray Open bit is set to zero, the Tray or Door mechanism is in the closed state. If the Door or Tray Open bit is set to one, the Tray or Door mechanism is in the open state. If the Drive does not have either a tray or a door, this bit shall be set to zero.

6.7.2.6.3 Start Slot

Start Slot field defines the first slot of a multiple slot Drive the media status notification applies to. For Drives that do not support multiple slots, this field shall be reserved.

The slot numbers are defined in the MECHANISM STATUS command, see 6.11.

6.7.2.6.4 End Slot

End Slot field defines the last slot of a multiple slot Drive the media status notification applies to. For Drives that do not support multiple slots, this field shall be reserved.

The slot numbers are defined in the MECHANISM STATUS command, see 6.11.

6.7.2.7 Multiple Host Events

When the Notification Class code in the Event Header is 101b, a Multiple Host Event Descriptor (Table 288) follows the header.

Multi-Host Class Events notify the Host of requests for control by other Hosts.

Table 289 — Multiple Host Descriptor

Bit	7	6	5	4	3	2	1	0
Byte								
0	Reserved				Event Code			
1	Persistent Prevented	Reserved			Multiple Host Status			
2	(MSB) Multiple Host Priority							(LSB)
3								

The Multi-Host Event field reports requests for control of and reporting of changes in Drive state. If a Persistent Prevent is in place for that Host, the Drive shall not perform the action requested. If a Persistent Prevent is not in place for that Host, the Drive shall notify the Host of actions that change the Drive state.

The Multi-Host Events are listed in Table 290.

Table 290 — Multiple Host Event Format

Code	Event	Description
0h	NoChg	No changes in the Drive Operational state performed or requested
1h	Control Request	Another Host has requested Drive control.
2h	Control Grant	Another Host has received Drive control.
3h	Control Release	Another Host has released Drive control.
4h – Fh	Reserved	

The Host may respond to Events 1-3 with no action or an appropriate Persistent Prevent or Persistent Allow.

The Persistent Prevented bit reports the current state of the Persistent Prevent for the Drive.

The Multiple Host Status (Table 291) field reports the Drive ability to respond to the Host.

Table 291 — Multiple Host Status Codes

Code	Status	Description
0h	Ready	The Drive is ready for operation
1h	Other Prevent	Indicates that another Host has an active Persistent Prevent. The Persistent Prevented bit shall be set to one.
2h – Fh	Reserved	Reserved

The Multiple Host Priority (Table 292) reports the other Host's relative priority.

Table 292 — Multiple Host Priority Codes

Code	Status	Description
0h	No Request	No requests are pending
1h	Low	There are no tasks pending on the Host for this Drive.
2h	Medium	There are no critical tasks pending on the Host for this Drive.
3h	High	There are critical tasks pending on the Host for this Drive
4h – FFFFh	Reserved	

6.7.2.8 Device Busy Events

When the Notification Class code in the Event Header is 110b, a Device Busy Event Descriptor (Table 293) follows the header.

Device Busy Events are used to notify the Host of commands that are executing but that require an abnormally long time to complete. Conditions that may cause the Drive to become Busy are defined in 4.1.6.2.

Table 293 — Device Busy Event Descriptor

Bit	7	6	5	4	3	2	1	0
Byte								
0	Reserved				Event Code			
1	Device Busy Status							
2	(MSB) Time							
3	(LSB)							

The Device Busy Event code is defined in Table 294.

Table 294 — Device Busy Event Codes

Code	Event	Description
0h	NoChg	The Drive Busy state has not changed.
1h	Change	The Drive Busy state has changed
2h – Fh	Reserved	

The Device Busy Status byte is defined in Table 295.

Table 295 — Device Busy Status

Code	Status	Description
00h	Not Busy	The Drive is Not Busy.
01h	Busy	The Drive is Busy.
02h – FFh	Reserved	

The Time field is the predicted amount of time remaining for the Drive to become not busy, in units of 100ms. If the Device Busy Status is Not Busy, the contents of the Time field are unspecified.

In order to assure accurate timing information, any command that may cause the Drive Busy condition should not be queued.

If both the Host and the Drive support command queuing, the Host should issue a GESN command requesting only the Device Busy Event class with the Polled bit in the CDB set to zero prior to issuing the command that may cause a Drive Busy condition. If the Drive becomes busy, the first GESN command shall be performed to report the Change (Not-Busy to Busy transition). The Host may issue another GESN command for the purpose of being notified of completion. Once the command has stopped executing, the second GESN command shall be performed to report the Change (Busy to Not-Busy transition).

Figure 126 shows the flow of execution of a command that may cause a Drive Busy condition.

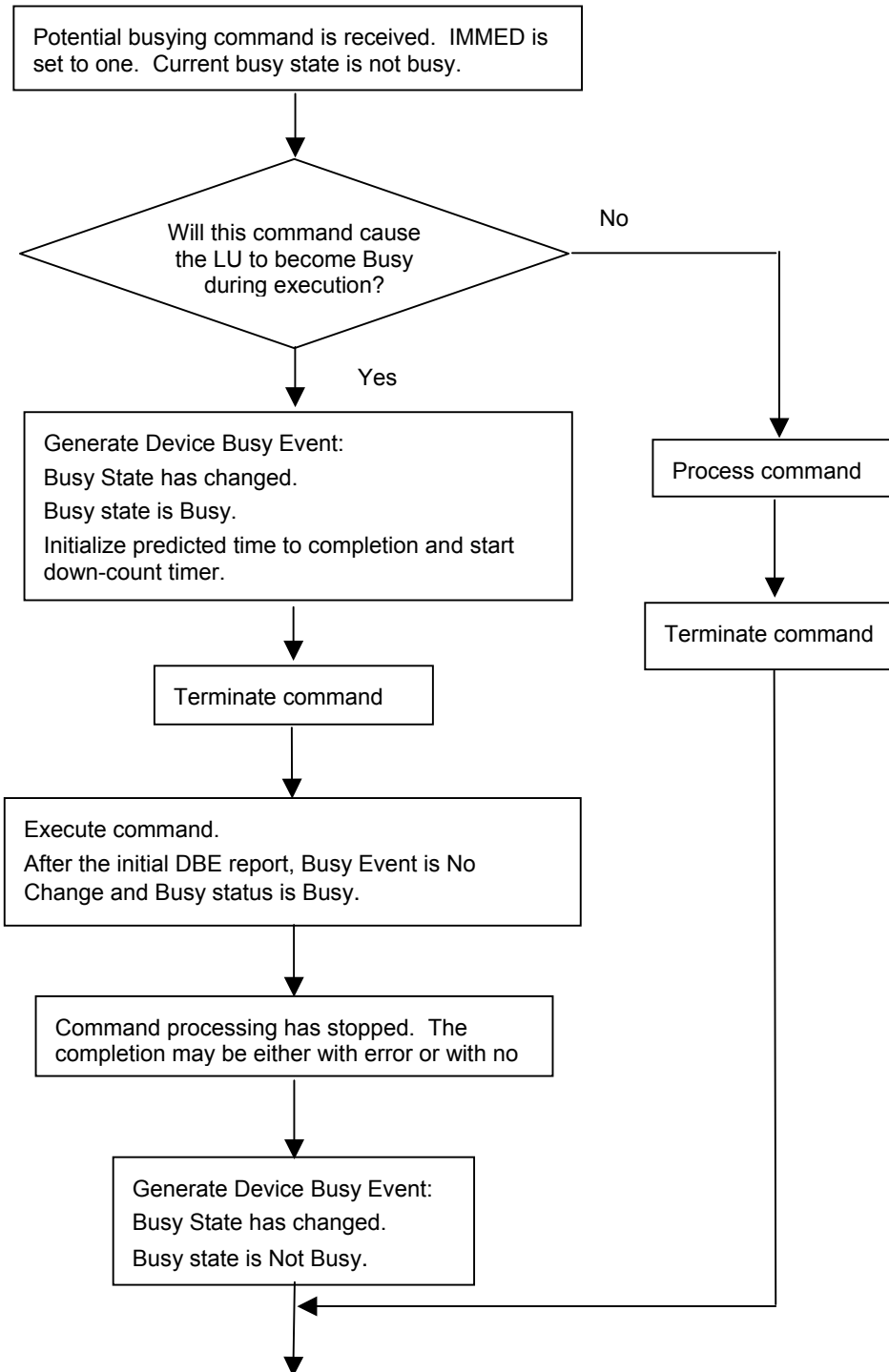

Figure 126 — Execution of a command that may cause Drive Busy

6.7.3 Timeouts

Command Processing timeouts as specified by the Timeout Feature do not apply to the GET EVENT STATUS NOTIFICATION command.

6.7.4 Error Reporting

Recommended error reporting for the GET EVENT STATUS NOTIFICATION Command is defined in Table 296.

Table 296 — Recommended Errors for GET EVENT STATUS NOTIFICATION Command

Error	Reference
CDB or parameter list validation errors	Table F.2

6.8 GET PERFORMANCE Command

6.8.1 Introduction

The GET PERFORMANCE command provides a method for the Host to obtain detailed information about the performance of the Drive. The command also provides a means for the Host to get current status and events that occurred during Stream recording/playback operation. Performance parameters are reported separately for read and write.

Table 297 shows the features associated with the GET PERFORMANCE command.

Table 297 — Features Associated with the GET PERFORMANCE Command

Feature Number	Feature Name	Command Requirement ¹
0029h	Enhanced Defect Reporting	Mandatory
002Ch	Rigid Restricted Overwrite	Mandatory
0107h	Real-time Streaming	Mandatory

¹The command requirement is valid only when the feature is current.

6.8.2 The CDB and its Parameters

6.8.2.1 The CDB

The GET PERFORMANCE CDB is shown in Table 298.

Table 298 — GET PERFORMANCE CDB

Bit	7	6	5	4	3	2	1	0
Byte								
0	Operation Code (ACh)							
1	Reserved			Data Type				
2	(MSB) Starting LBA (LSB)							
3								
4								
5								
6								
7	Reserved							
8	(MSB) Maximum Number of Descriptors (LSB)							
9								
10	Type							
11	Control							

6.8.2.2 Data Type

The Data Type field definition is dependent upon the Type field value.

6.8.2.3 Starting LBA

Use of the Starting LBA field is determined by the contents of the Type field.

6.8.2.4 Maximum Number of Descriptors

The Drive shall not return more performance descriptors than specified by the Maximum Number of Descriptors field. If Maximum Number of Descriptors is zero, then only the descriptor header shall be returned.

6.8.2.5 Type

The Type field specifies the type of data requested. Table 299 shows the valid values for Type.

Table 299 — Type Field Definitions

Type Field	Description
00h	Performance data
01h	Unusable Area data
02h	Defect Status data
03h	Write Speed Descriptor
04h	DBI
05h	DBI Cache Zone
06h – FFh	Reserved

If the Drive does not support the specified value of Type field for the mounted medium, the Drive shall terminate this command with CHECK CONDITION status and set SK/ASC/ASCQ values to ILLEGAL REQUEST/INVALID FIELD IN CDB.

6.8.3 Command Processing

6.8.3.1 Overview

The performance response (Table 300) shall contain a Performance header and zero or more Performance descriptors.

Table 300 — Performance response format

Bit	7	6	5	4	3	2	1	0
Byte								
0 – 7	Performance Header							
8 – n	Performance Descriptor(s)							

The Performance Header is defined in Table 301.

Table 301 — Performance Header

Bit	7	6	5	4	3	2	1	0
Byte								
0	(MSB) Performance Data Length (LSB)							
1								
2								
3								
4	Reserved					Write	Except	
5	Reserved							
6	Reserved							
7	Reserved							

The Performance Data Length field shall specify the amount of result data not including the Performance Data Length. This value is not modified when the allocation length indicated by the Maximum Number of Descriptors is insufficient to return all of the data available.

The values of Write and Except are dependent upon the Performance Type.

6.8.3.2 Performance (Type field = 00h)

The command reports its characteristics of reading/writing performance.

The Data Type Field (Table 302) is a collection of bit fields that specify the form of the returned descriptor.

Table 302 — Data Type Field Definitions for Type = 00h

Data Type Bit Fields				
4	3	2	1	0
Tolerance		Write	Except	
00b = Reserved		0b = Read Performance	00b = nominal performance	
01b = Reserved			01b = Entire performance list	
10b = 10%, nominal; 20%, exceptions		1b = Write Performance	10b = performance exceptions only	
11b = Reserved			11b reserved	

The Starting LBA field in the CDB is valid only when Except = 01b. If Except = 01b, the Starting LBA field shall indicate the starting point for returning performance data. All performance data shall be for logical block addresses greater than or equal to this LBA.

The Write bit (in the Header), when set to zero, shall indicate that the result data is for read performance using the nominal command for the data type. When set to one, shall indicate that the result data is for write performance.

The Except bit (in the Header), when set to zero, shall indicate that the result data is for nominal performance (see Table 303). When set to one, shall indicate that the result data is for exception conditions (Table 304). Performance Descriptors shall be returned for the current medium. If no media is present, Performance Descriptors for the fastest medium shall be returned.

The Performance Descriptors (Table 303) for nominal performance are intended to give the Host an approximation of Drive performance. All numbers are nominal. On CD media, all sectors shall be reported as 2 352 byte sectors. The descriptor includes a Start LBA value, a Start Performance value in increments of 1 000 Bytes/second, an End LBA value, and an End Performance value in increments of 1 000 Bytes/second.

Table 303 — Performance Descriptor – Nominal Performance

Bit Byte	7	6	5	4	3	2	1	0
0	(MSB)							
1	Start LBA							
2								
3	(LSB)							
4	(MSB)							
5	Start Performance							
6								
7	(LSB)							
8	(MSB)							
9	End LBA							
10								
11	(LSB)							
12	(MSB)							
13	End Performance							
14								
15	(LSB)							

The Start LBA field contains the first logical block address of the extent described by this descriptor.

The Start Performance field contains the nominal Drive performance at the Start LBA.

The End LBA field contains the last logical block address of the extent described by this descriptor.

The End Performance field contains the nominal Drive performance at the End LBA.

Table 304 — Performance Descriptor – Exceptions

Bit Byte	7	6	5	4	3	2	1	0
0	(MSB) LBA							
1								
2								
3	(LSB)							
4	(MSB)				Time			
5	(LSB)							

The LBA field shall indicate that there is a seek delay between (LBA – 1) and LBA.

The Time field shall indicate the expected additional delay between (LBA – 1) and LBA from nominal, in units of tenths of milliseconds (100 microseconds). This seek delay may be due to linear replacement, zone boundaries, or other media dependent Features. The expected additional delay should represent the typical time expected for the type of exception described.

Note 13. A block replaced by linear replacement may cause two exceptions to appear in the Exception Descriptor list – one between the non-replaced area and the beginning of the replaced block, and one from the end of the replaced block back to the non-replaced area.

6.8.3.3 Unusable Area Data (Type=01h)

This command reports data to the Host that how the physically unusable areas are allocated on the mounted writable media. If the mounted media is not a writable media, the Drive shall terminate the command with CHECK CONDITION status and set SK/ASC/ASCQ values to ILLEGAL REQUEST/INVALID FIELD IN CDB.

The corresponding parameter field allocation is specified in Table 305.

The Unusable Area Type field specifies the type of the unusable area to be transferred. See Table 305.

Table 305 — Unusable Area Type values

Unusable Area Type value	Description
000b	Zone boundary information
001b	PDL information
010b	SDL information
Others	Reserved

The Write and Except bits in the Performance Header for Unusable Area data are not used and shall be set to zeros.

All Unusable Area data shall be for LBAs that are greater than or equal to the Starting LBA specified in the CDB. Each Unusable Area Descriptor shall be transferred to the Host in ascending order.

Table 306 — Unusable Area Descriptor

Bit Byte	7	6	5	4	3	2	1	0
0	(MSB) LBA (LSB)							
1								
2								
3								
4	(MSB) Number of Unusable Physical Blocks (LSB)							
5								
6								
7								

The LBA field shall specify the first LBA of the unusable area if the Unusable Area Type field in CDB is set to 010b. The LBA field shall specify the LBA just before the unusable area when the Unusable Area Type field in CDB is set to 000b or 001b.

The Number of Unusable Physical Blocks field shall specify number of physical blocks included in the specified unusable area. When the Unusable Area Type field in CDB is set to 000b, this field is reserved.

6.8.3.4 Defect Status data (Type=02h)

This command reports Defect Status data to the Host that is created by certification on Restricted Overwrite media or by TSR writing. If the mounted media is not a Restricted Overwrite media or if the Drive does not support certification, and if the Drive does not support TSR on the current media, this command shall be terminated with CHECK CONDITION status and SK/ASC/ASCQ values shall be set to ILLEGAL REQUEST/INVALID FIELD IN CDB.

The Data Type field in CDB shall be set to zero.

All Defect Status data shall be for LBAs that are greater than or equal to the Starting LBA specified in the CDB. In the case of TSR, the host when reading defect information after the Drive reported CHECK CONDITION and sense bytes SK/ASC/ASCQ MEDIUM ERROR/WRITE ERROR. RECOVERY NEEDED shall set the Starting LBA in the CDB to the lowest LBA for which the host knows the data (according the Error Reporting Window size).

The Write and Except bits in the Performance Header for Defect Status data are not used and shall be set to zeros.

Defect Status Descriptors shall be transferred to the Initiator in ascending order. If the certified areas are non-contiguous and scattered, separate descriptors, to exclude the void areas shall return the Defect Status Descriptor(s).

The Defect Status Data Length field shall specify the amount of data that follows the Defect Status Data Length field. If there is no Defect Status data on the medium, Defect Status Data Length field shall be set to 4 and no Defect Status Descriptor shall be transferred.

Table 307 — Defect Status Descriptor

Bit Byte	7	6	5	4	3	2	1	0
0	Start LBA (MSB) (LSB)							
1								
2								
3								
4	End LBA (MSB) (LSB)							
5								
6								
7								
8	Blocking Factor							
9	Reserved					First Bit Offset		
10	DS #8	DS #7	DS #6	DS #5	DS #4	DS #3	DS #2	DS #1
...
2047	DS # 16 304	DS # 16 303	DS # 16 302	DS # 16 301	DS # 16 300	DS # 16 299	DS # 16 298	DS # 16 297

The Start LBA field contains the start Logical Block Address of the certified sector where the following Defect Status (DS #n bits) starts. The returned Logical Block Address shall be the first sector of a Block that contains logical blocks specified by the Blocking Factor field.

The End LBA field contains the end Logical Block Address of the certified sector where the following Defect Status (DS #n bits) ends. The returned Logical Block Address shall be the last sector of a Block that contains logical blocks specified by the Blocking Factor field.

The Blocking Factor field shall indicate the number of logical blocks per DS #n bit. In the case of DVD-RW and DVD-RAM, this field shall be set to 16 as an ECC Block. In the case of HD DVD-Rewritable, BD-R and BD-RE, this field shall be set to 32 as an ECC Block or Cluster.

The First Bit offset field shall indicate the start valid bit number in byte 10. The lower bits in byte 10 are invalid. e.g., if First Bit offset field contains 3, bit 3 of byte 10 has the defect status of the block that contains the Logical block specified Start LBA field. From bit 2 to bit 0 are invalid in this case.

DS #n bit contains the certification result of the block #m. When DS #n bit is set to 0, indicate that the block has no defect and is able to read and write the block safely. When DS #n bit is set to 1, indicates that the block has defect and might not be able to read and write the block safely.

6.8.3.5 Write Speed (Type=03h)

This command reports a list of possible Write Speed descriptors. If recordable media is mounted, Drive shall report the list of speeds that are available for the Blocks of the current mounted medium. If no recordable media is mounted, the Drive shall report the most appropriate list of speeds or only the maximum recording speed. Write Speed descriptors shall be reported in descending order of the Write Speed value. If the Drive supports both CLV and CAV on the media, then the Drive shall report all CLV descriptors first. The Host may determine a desired write speed descriptor from the result of this command, then set the Write Speed accordingly via the SET STREAMING command. To apply this descriptor to the SET STREAMING command, the Start LBA field is set to 0, the Read Time field and the Write Time field are set to 1000 (1sec).

Table 308 — Write Speed Descriptor

Bit Byte	7	6	5	4	3	2	1	0
0	Reserved			WRC		RDD	Exact	MRW
1	Reserved							
2	Reserved							
3	Reserved							
4	(MSB) End LBA (LSB)							
5								
6								
7								
8	(MSB) Read Speed (LSB)							
9								
10								
11								
12	(MSB) Write Speed (LSB)							
13								
14								
15								

The Write Rotation Control (WRC) field specifies the type of the medium Rotation Control. See Table 309.

Table 309 — Write Rotation Control values

WRC value	Description
00b	CLV and non-pure CAV
01b	Pure CAV
Others	Reserved

Media default rotation control is the rotation control defined by the media specification. Media default rotation control is typically:

- a) CD-R/RW CLV
- b) DVD-R/-RW CLV
- c) DVD-RAM ZCLV
- d) DVD+RW CLV
- e) HD DVD-R CLV
- f) HD DVD-RAM ZCLV
- g) BD CLV

If default rotation control is CAV, this field shall be set to zero.

RDD bit shall be set to zero.

Exact bit of one indicates that the Drive may perform the recording operation specified by Write Speed Descriptor on the whole media mounted. If the Drive is uncertain, this bit shall set to zero.

The MRW bit indicates that this Write Speed Descriptor is suitable for mixture of read and write (e.g. overwrite mode).

The End LBA field shall indicate the medium capacity if a medium is mounted. The value shall be same as the value reported by READ CAPACITY command. If no medium is mounted, the Drive shall report the maximum capacity of the most appropriate media.

The Read Speed field shall indicate the lowest read performance data of all Blocks in kilobytes per second.

The Write Speed field shall indicate the lowest write performance data of all Blocks in kilobytes per second.

Note 14. The Write Speed (Type field = 03h) format may not be able show the difference between 6X CLV and 6X-8X ZCLV on DVD-R/+R media. 6X-8X ZCLV may be regarded as 8X CLV. The correct write speed profile and read speed profiles that are selected are shown by Performance (Type field = 00h) format.

6.8.3.6 DBI (Type=04h)

This command reports a list of Defective Block Information (DBI) data that is a certification result of the medium. To keep compatibility among three DBI memory models described in 4.7.4.5, "DBI memory management", the Host should specify the correct logical block address to be read for defect information in the Starting LBA field of GET PERFORMANCE CDB.

If the Drive supports Enhanced Defect Reporting Feature but this Feature is not current, only DBI data Header shall be reported. If the Drive does not support Enhanced Defect Reporting Feature, this command shall be terminated with CHECK CONDITION status and SK/ASC/ASCQ values shall be set to ILLEGAL REQUEST/INVALID FIELD IN CDB.

The result data shall be formatted as shown in Table 290, Table 311, and Table 312.

The result data shall be formatted as listed in Table 277.

Table 310 — DBI data

Bit	7	6	5	4	3	2	1	0
Byte								
0-7	DBI data Header							
8-n	DBI Descriptor(s)							

Table 311 — DBI data Header

Bit	7	6	5	4	3	2	1	0
Byte								
0	(MSB) DBI Data Length (LSB)							
1								
2								
3								
4-7	Reserved							

The DBI Data Length field specifies the length in bytes of the following result data. The DBI Data Length value does not include the DBI Data Length field itself. This value is not modified when the Maximum number of descriptors is insufficient to return all of the DBI data available.

Table 312 — DBI Descriptor

Bit	7	6	5	4	3	2	1	0
Byte								
0	(MSB) Start LBA of defective blocks (LSB)							
1								
2								
3								
4	(MSB) Number of consecutive defective blocks (LSB)							
5								
6	Reserved			DBIF	Error Level Type			
7	Reserved							

The Start LBA of defective blocks field indicates the start LBA of defective blocks on the medium. The value shall be the packet start LBA that the packet includes the sector specified by the Starting LBA field in CDB.

The Number of consecutive defective blocks field indicates the number of consecutive defective blocks from the LBA specified by the Start LBA of defective blocks field.

The DBI Full (DBIF) bit indicates that incomplete verify operation occurs due to DBI memory full when Simple DBI memory model or small DBI cache memory model is used (see 4.7.4.5, “DBI memory management”). If this bit is set to 1, the VERIFY (10) or WRITE AND VERIFY (10) command was terminated at the address calculated from this descriptor before certification completion of specified number of blocks in CDB. The actual terminated address of VERIFY (10) or WRITE AND VERIFY (10) command is “Start LBA of defective blocks” + “Number of consecutive defective blocks” – 1. To continue the verification of the blocks, the Host should issue VERIFY (10) command from “Start LBA of defective blocks” + “Number of consecutive defective blocks” address.

If this bit is set to 0, indicates that the VERIFY (10) or WRITE AND VERIFY (10) command is terminated without DBI memory full.

At the beginning of the next VERIFY (10)/WRITE AND VERIFY (10) command or at the medium change, the DBIF bit shall be set to zero. By transferring the DBI descriptor of DBIF = 1 or by performing of READ (10)/READ (12) command, this bit shall not be cleared.

In the case of small DBI cache memory model, when WDBI cache is updated by the WRITE (10)/WRITE (12) command, the DBIF bit shall be set to zero.

The Error Level Type field indicates the type of the error level of the defective blocks. See Table 293.

Table 313 — Error Level Type values

Error Level Type value	Error Level Type	Description
0	Type 1	Recovered light defect in specified defective blocks. Data in the blocks may be recovered by error correction.
1	Type 2	Recovered heavy defect in specified defective blocks. Data in the blocks may be recovered by error correction and multiple retry seek/read action.
2	Type 3	Un-recovered read/seek error defect in specified defective blocks.
3	Type 4	Write error occurs in the specified defective blocks. Data had not be written on the sectors.
Others	Others	Reserved

6.8.3.7 DBI cache zone (Type=05h)

This command reports a list of Defective Block Information (DBI) data that is a certification result of the medium. To keep compatibility among three DBI memory models described in 4.7.4.5, “DBI memory management”, the Host should specify the correct logical block address to be read for defect information in the Starting LBA field of GET PERFORMANCE CDB.

If the Drive supports Enhanced Defect Reporting Feature but this Feature is not current, only DBI data Header shall be reported. If the Drive does not support Enhanced Defect Reporting Feature, this command shall be terminated with CHECK CONDITION status and SK/ASC/ASCQ values shall be set to ILLEGAL REQUEST/INVALID FIELD IN CDB.

The result data shall be formatted as listed in Table 552, Table 614, and Table 554.

The DBI cache zone descriptor provides a way for the Host to indicate to the Drive that the application has specific request for Drive behavior of small DBI cache model in DRT-DM mode. Disc volume space is divided into a few DBI cache zones. RDBI and WDBI memory shall be allocated for each DBI cache zones. Minimally 2 DBI cache zones shall be supported. Number of supported DBI cache zone is shown in Number of DBI cache zones field of Table 124 – Enhanced Defect Reporting Feature Descriptor.

If the Drive supports “Simple DBI memory model” (see 4.7.4.5.2), the Drive shall terminate this command with CHECK CONDITION status and SK/ASC/ASCQ values shall be set to ILLEGAL REQUEST/INVALID FIELD IN CDB. If the Drive supports “Large DBI buffer memory model” (see 4.7.4.5.3), the Drive shall report single DBI cache zone that starts from LBA 0 to the end of the medium.

The descriptor data shall be formatted as listed in **Error! Reference source not found.** – DBI cache zone Descriptor(s).

6.8.4 Timeouts

The GET PERFORMANCE command belongs to timeout group 1. If the command is terminated with CHECK CONDITION status due to a timeout, sense bytes SK/ASC/ASCQ shall be set to UNIT ATTENTION/INSUFFICIENT TIME FOR OPERATION.

6.8.5 Error Reporting

Recommended error reporting is defined in Table 314.

Table 314 — Recommended errors for GET PERFORMANCE Command

Error	Reference
Unit Attention conditions	Table F.1
CDB or parameter list validation errors	Table F.2
Readiness errors	Table F.3
General media access errors	Table F.5
Hardware failures	Table F.8

6.9 INQUIRY Command

6.9.1 Introduction

The INQUIRY Command requests that information regarding identification of the Drive be sent to the Host. Options allow the Host to request additional information about the Drive. Features that specify implementation of the INQUIRY command are listed in Table 315.

Table 315 — Features Associated with the INQUIRY Command

Feature Number	Feature Name	Command Requirement
0001h	Core Feature	Mandatory

The INQUIRY command is described in [SPC-3]. The description of command behavior is consistent for all Drives, however, there are variations in INQUIRY data for ATAPI and USB connected Drives.

6.9.2 INQUIRY Data for ATAPI and USB Drives

ATAPI and USB Drives shall have at least 36 bytes if INQUIRY data available according to Table 316.

Table 316 — INQUIRY Data for ATAPI and USB Drives

Field	Value	Field	Value
Peripheral Device Type	00101b	MCHNGR	0b
Peripheral Qualifier	000b	MultIP	0b
RMB	1b	VS1	0b
Version	According to [SPC-3]	EncServ	0b
Response Data Format	0011b	BQUE	0b
HiSup	0b	VS2	0b
NormACA	0b	CmdQue	0b
Protect	0b	LINKED	0b
3PC	0b	SYNC	0b
TPGS	0b	WBUS16	0b
ACC	0b	Vendor Identification	According to [SPC-3]
SCCS	0b	Product Identification	According to [SPC-3]
ADDR16	0b	Product Revision Level	According to [SPC-3]

All fields beyond byte 35 may be available in ATAPI and USB Drives. If available, those fields shall be according to [SPC-3].

6.9.3 Timeouts

Command Processing timeouts as specified by the Timeout Feature do not apply to the INQUIRY command.

6.9.4 Error Reporting

Table 317 describes errors that may occur during the operation of the Command or that may cause a CHECK CONDITION status to be reported.

Table 317 — INQUIRY Command Errors

Error	Reference
CDB or parameter list validation errors	

6.10 LOAD/UNLOAD MEDIUM Command

6.10.1 Introduction

The LOAD/UNLOAD MEDIUM command requests the Drive Changer to load or unload a Disc. This command is associated with the features listed in Table 318.

Table 318 — Features Associated with the LOAD/UNLOAD MEDIUM Command

Feature Number	Feature Name	Command Requirement ¹
0102h	Embedded Media Changer	Mandatory
¹ The command requirement is valid only when the feature is current.		

6.10.2 The CDB and its Parameters

6.10.2.1 The CDB

The LOAD/ONLOAD MEDIUM CDB is shown in Table 319.

Table 319 — LOAD/UNLOAD MEDIUM CDB

Bit Byte	7	6	5	4	3	2	1	0
0	OPERATION CODE (A6h)							
1	Reserved			Reserved			IMMED	
2	Reserved							
3	Reserved							
4	Reserved						LoUnlo	Start
5	Reserved							
6	Reserved							
7	Reserved							
8	SLOT							
9	Reserved							
10	Reserved							
11	Control							

6.10.2.2 IMMED

If the IMMED is set to zero, the command shall not be terminated until the load/unload operation has completed. If the IMMED bit is set to one the Drive shall return status as soon as the CDB has been validated.

6.10.2.3 Start and LoUnlo

Meanings of the Start and LoUnlo bits are defined in Table 320.

Table 320 — LoUnlo/Start Operation

LoUnlo	Start	Operation
0	0	Abort any prior changer command
0	1	Reserved
1	0	Unload media. The Slot parameter has no meaning
1	1	Either move the disc in the selected slot to the play position or select the specified slot for use with media access commands

6.10.2.4 Slot

The Slot field indicates the Slot to be loaded. The Drive should always initialize (Load) Slot 0 at Power On or Hard Reset.

If a Load is requested when the requested slot does not contain a disc, the Drive shall terminate the command with CHECK CONDITION Status and set SK/ASC/ASCQ values to NOT READY/MEDIUM NOT PRESENT.

If an Unload is requested when the Play Position does not contain a disc, the Drive shall terminate the command with CHECK CONDITION Status and set SK/ASC/ASCQ values to ILLEGAL REQUEST/INVALID FIELD IN CDB for the Slot Byte.

6.10.3 Command Processing

No UNIT ATTENTION Condition shall be generated for the Host issuing the LOAD/UNLOAD MEDIUM Command when discs are loaded or unloaded from the playing position.

6.10.4 Timeouts

The LOAD/UNLOAD MEDIUM command belongs to timeout group 2 when IMMED is zero. The group 2 timeout value is only for Host information. The Drive shall not time group 2 timeout commands. Execution shall continue until completion.

When the IMMED is set to one, status shall be returned within a Group 1 timeout.

6.10.5 Error Reporting

When the command operation began with the CDB IMMED bit set to one, it is possible that a deferred error may be reported in some future command.

Table 321 describes errors that may occur during the operation of the Command or that may cause a CHECK CONDITION status to be reported.

Table 321 — LOAD/UNLOAD MEDIUM Command Errors

Error	Reference	May be Deferred
Unit Attention conditions	Table F.1	
CDB or parameter list validation errors	Table F.2	
Readiness errors	Table F.3	
Hardware failures	Table F.8	√

6.11 MECHANISM STATUS Command

6.11.1 Introduction

The Mechanism Status command requests that the Drive respond with the current status of the device, including any Changer Mechanism that adheres to this standard. This command is intended to provide information to the Host about the current operational state of the Drive. The Drive takes operational direction from both the Host and the user. Movement of media in/out of the Drive as well as Play operations may be due to external controls or Host commands. This command provides a method that allows the Host to know what has transpired with the changer mechanism.

Table 322 shows the features associated with this command.

Table 322 — Features Associated with the MECHANISM STATUS Command

Feature Number	Feature Name	Command Requirement ¹
0003h	Removable Medium	Mandatory
0102h	Embedded Media Changer	Mandatory
¹ The command requirement is valid only when the feature is current.		

6.11.2 The CDB and its Parameters

The MECHANISM STATUS CDB is shown in Table 323.

Table 323 — MECHANISM STATUS CDB

Bit	7	6	5	4	3	2	1	0	
0	Operation code (BDh)								
1	Reserved								
2	Reserved								
3	Reserved								
4	Reserved								
5	Reserved								
6	Reserved								
7	Reserved								
8	(MSB)	Allocation Length							
9								(LSB)	
10	Reserved								
11	Control								

The Allocation Length field specifies the maximum length, in bytes, of the Mechanism Status Parameter list that shall be transferred from the Drive to the Host. An Allocation Length field of zero indicates that no data shall be transferred. This condition shall not be considered an error.

6.11.3 Command Processing

The Mechanism Status Parameter list returned contains a header followed by zero or more fixed-length Slot Tables (Table 324). If the Drive does not support the changer commands, then the number of slot tables returned to the Host should be zero.

Table 324 — Mechanism Status Parameter List Format

Bit	7	6	5	4	3	2	1	0
Byte								
0 – 7	Mechanism Status Header							
8 – n	Slot Tables							

The Mechanism Status Header format is shown in Table 325.

Table 325 — Mechanism Status Header

Bit	7	6	5	4	3	2	1	0								
Byte																
0	Fault	Changer State		Current Slot (Low order 5 bits)												
1	Mechanism State			Door open	Reserved	Current Slot (High order 3 bits)										
2	(MSB) (LSB)															
3									Current LBA (Legacy)							
4																
5									Number of Slots Available							
6	(MSB)				Length of Slot Tables				(LSB)							
7																

The Fault bit indicates that the changer failed to complete the operation reported in the Changer State field. The Changer State field (Table 326) indicates the current state of the changer.

Table 326 — Changer State Field

Changer State	Definition
0h	Ready
1h	Load in Progress
2h	Unload in Progress
3h	Initializing

The Current Slot field (an 8-bit field) indicates the Current Slot selected. Changers compatible with a bootable device specification should always initialize (Load) Slot zero on power-on reset or hard reset. This value shall only be changed when a LOAD/UNLOAD command is processed. Operations initiated by a user shall not cause this value to change. If the Drive is not a changer, then this field is reserved.

The Mechanism State field (Table 327) encodes the current operation of mechanism.

Table 327 — Mechanism State Field

Mechanism State	Definition
0h	Idle
1h	Legacy definition - Playing (Audio or Data)
2h	Legacy definition - Scanning
3h	Legacy definition - Active with Host, Composite or Other Ports in use (i.e., READ)
4h-6h	Reserved
7h	No State Information Available

The Slot Table response data format is defined in Table 328. Each slot shall respond with the status defined.

The Door open bit, when set to one, indicates that the Door(s) or Tray(s) is open or the magazine is not present. If the Drive does not have either a tray or a door, this bit shall be set to zero.

The Current LBA value returns the location that was last used while reading or playing. Once a Read or Play operation has been completed the value of this field may be undefined. While a Read or Play is in progress this field shall contain the LBA of the current block being processed. This field is defined as Legacy.

The Number of Slots Available field indicates the number of slots available. The maximum number of slots is 255.

The Length of Slot Tables field specifies the length in bytes of the all the slot information that follows (e.g. for a 2 slot Drive this value is 8). The Slot Table format is shown in Table 328.

Table 328 — Slot Table Format

Bit	7	6	5	4	3	2	1	0
Byte								
0	Disc Present	Reserved	Reserved	Reserved	Reserved	Reserved	Reserved	Change
1	Reserved						CWP_V	CWP
2	Reserved							
3	Reserved							

The Disc Present bit indicates that there is a Disc in this slot. The reporting of this information is optional after a reset or Disc change. If this capability is not supported, the bit shall be set to one after a reset condition or when a medium has been changed. When the Drive is given a load command for a slot that contains no Disc, the bit corresponding to that slot shall then contain a zero for any following response.

The Change bit indicates that the Disc in that slot has been changed since the last time the disc was loaded. The Change bit is mandatory.

CWP_V, if set to one, indicates that the Media Cartridge Write Protection (CWP) of the Cartridge in that slot has been checked and CWP bit is valid. If CWP_V is zero, the CWP bit is invalid.

CWP, if set to 1, indicates that the CWP status is active on the Cartridge. If CWP_V is set to 0, CWP bit is invalid and shall be set to zero.

6.11.4 Timeouts

The MECHANISM STATUS command belongs to timeout group 1. If the command is terminated with CHECK CONDITION status due to a timeout, sense bytes SK/ASC/ASCQ shall be set to UNIT ATTENTION/INSUFFICIENT TIME FOR OPERATION.

6.11.5 Error Reporting

Recommended error reporting for the MECHANISM STATUS command is defined in Table 329.

Table 329 — Recommended errors for Mechanism Status Command

Error	Reference
Unit Attention conditions	Table F.1
CDB or parameter list validation errors	Table F.2

6.12 MODE SELECT (10) Command

6.12.1 Introduction

The MODE SELECT (10) command provides a means for the Host to specify medium, Drive, or peripheral device parameters. Hosts should issue MODE SENSE (10) prior to each MODE SELECT (10) to determine supported mode pages, mode page lengths, and current settings.

Table 330 shows the features associated with the MODE SELECT command.

Table 330 — Features Associated with the Mode Select Command

Feature Number	Feature Name	Command Requirement
0001h	Core Feature	Mandatory

The MODE SELECT (10) command is described in [SPC-3].

See clause 7 for detailed descriptions of mode pages, parameters and formats.

6.12.2 Timeouts

The MODE SELECT (10) command belongs to timeout group 1. If the command is terminated with CHECK CONDITION status due to a timeout, sense bytes SK/ASC/ASCQ shall be set to UNIT ATTENTION/INSUFFICIENT TIME FOR OPERATION.

6.12.3 Error Reporting

Recommended error reporting for the MODE SELECT (10) command is defined in Table 331.

Table 331 — Recommended errors for Mode Select (10) Command

Error	Reference
Unit Attention conditions	Table F.1
CDB or parameter list validation errors	Table F.2

6.13 MODE SENSE (10) Command

6.13.1 Introduction

The MODE SENSE (10) command provides a means for the Host to specify medium, Drive, or peripheral device parameters. Hosts should issue MODE SENSE (10) prior to each MODE SELECT (10) to determine supported mode pages, mode page lengths, and current settings.

Table 332 shows the features associated with the MODE SENSE command.

Table 332 — Features Associated with the Mode Sense Command

Feature Number	Feature Name	Command Requirement
0001h	Core Feature	Mandatory

The MODE SELECT (10) command is described in [SPC-3].

See clause 7 for detailed descriptions of mode pages, parameters and formats.

Note 15. Since MM Drives do not support sub-pages of mode pages, the Sub-Page field of the MODE SENSE (10) command is ignored by the Drive.

Note 16. Since MM Drives do not support Block Descriptors (see 7.2.1), the LLBAA bit in the MODE SENSE (10) CDB has no meaning and is ignored by the Drive.

6.13.2 Timeouts

The MODE SENSE (10) command belongs to timeout group 1. If the command is terminated with CHECK CONDITION status due to a timeout, sense bytes SK/ASC/ASCQ shall be set to UNIT ATTENTION/INSUFFICIENT TIME FOR OPERATION.

6.13.3 Error Reporting

Recommended error reporting for the MODE SENSE (10) command is defined in Table 333.

Table 333 — Recommended errors for Mode Sense (10) Command

Error	Reference
Unit Attention conditions	Table F.1
CDB or parameter list validation errors	Table F.2

6.14 PREVENT ALLOW MEDIUM REMOVAL Command

6.14.1 Introduction

The PREVENT/ALLOW MEDIUM REMOVAL Command requests that the Drive enable or disable the removal of the medium in the Drive. The Drive shall not allow medium removal if any Host currently has medium removal prevented. The method of prevention of medium removal is vendor specific.

[SPC-3] describes a PREVENT ALLOW MEDIUM REMOVAL command; however, the [SPC-3] description does not apply to MM devices.

Table 334 shows the Features associated with the PREVENT ALLOW MEDIUM REMOVAL command.

Table 334 — Features Associated with the PREVENT ALLOW MEDIUM REMOVAL Command

Feature Number	Feature Name	Command Requirement
0002h	Morphing	Mandatory
0003h	Removable Medium	Mandatory

6.14.2 The CDB and its Parameters

The PREVENT ALLOW MEDIUM REMOVAL CDB is shown in Table 335.

Table 335 — PREVENT ALLOW MEDIUM REMOVAL CDB

Bit	7	6	5	4	3	2	1	0
Byte								
0	Operation Code (1Eh)							
1	Reserved							
2	Reserved							
3	Reserved							
4	Reserved						Persistent	Prevent
5	Control							

The Drive maintains two separate Prevent states: Prevent and Persistent Prevent as described in 4.1.7. The Persistent and Prevent bits are used to independently select values for these states. See Table 336.

Table 336 — State Selection

Persistent	Prevent	Meaning
0	0	Prevent State shall be cleared (Unlocked)
0	1	Prevent State shall be set (Locked)
1	0	Persistent Prevent State shall be cleared (Persistent Allow)
1	1	Persistent Prevent State shall be set (Persistent Prevent)

The recommended default state at power-on or hard reset is Prevent State cleared and Persistent Prevent State cleared.

6.14.3 Command Processing

6.14.3.1 Overview

The selected state begins upon successful completion of the PREVENT ALLOW MEDIUM REMOVAL command.

6.14.3.2 Persistent Prevent State

Upon entering the Persistent Prevent state, the Drive shall disable any eject mechanisms, and all media after initial media spin up shall remain locked in the Drive until the Host issues an eject request, or the Persistent Prevent status is reset and the hardware eject mechanism again becomes available.

The Persistent Prevent status shall be reset upon receipt of a PREVENT/ALLOW MEDIUM REMOVAL command (from the same Host that originally set the Persistent Prevent state) with the Persistent bit set and the Prevent bit cleared, a bus reset, or a power reset condition.

Upon insertion of new media, under Persistent Prevent conditions, the Drive eject controls shall remain functional up until the Drive generates or reports a New Media event as defined in the Media Events section. After this event has been generated or reported, the media shall remain locked as defined above. The Drive is allowed to morph from the no medium present state to the medium present state without explicit direction from the Host.

The Drive shall not report a New Media Event if the medium is removed between the generation of the Event and the next GET EVENT/STATUS NOTIFICATION command issued.

The Persistent Prevent state shall not prevent an eject request from the Host from succeeding.

6.14.3.3 Prevent State

The Prevent State (Locked) is entered upon successful completion of the PREVENT/ALLOW MEDIUM REMOVAL command where Prevent State is set.

The prevention of medium removal for the Drive shall terminate:

1. After the Host has issued a PREVENT/ALLOW MEDIUM REMOVAL command clearing Prevent State and the Drive has successfully performed a flush cache operation; or
2. Upon a Hard Reset condition; or
3. Upon a DEVICE RESET in an ATAPI environment; or

While a prevention of medium removal condition is in effect the Drive shall inhibit mechanisms that normally allow removal of the medium by an operator. This is also the case for changers.

Unlocked is the recommended default state of the Drive at power on.

This command affects the actions of the START/STOP UNIT command (6.39) and other mechanisms (e.g. manual ejection / media removal systems).

Table 337 — Actions for Lock/Unlock/Eject

Operation	Current Prevent State	No Media Present	Media Present and READY
Unlock	Unlocked	No error	No error.
	Locked	No error, medium may be inserted.	No error, medium may be removed.
Lock	Unlocked	No Error, media insertion is not permitted	No Error, media to be removal is not permitted
	Locked	No error	No error
Start/Stop Unit with Start=0 and LoEj=1	Unlocked	No error. Media mount mechanism is opened.	No error. Media is ejected.
	Locked	CHECK CONDITION, SK/ASC/ASCQ = NOT READY/MEDIUM REMOVAL PREVENTED	CHECK CONDITION, SK/ASC/ASCQ = ILLEGAL REQUEST/MEDIUM REMOVAL PREVENTED
Manual Eject	Unlocked	Media mount mechanism is opened.	Media is ejected.
	Locked	No visible operation occurs.	No visible operation occurs.

6.14.4 Timeouts

The PREVENT ALLOW MEDIUM REMOVAL command belongs to timeout group 1. If the command is terminated with CHECK CONDITION status due to a timeout, sense bytes SK/ASC/ASCQ shall be set to UNIT ATTENTION/INSUFFICIENT TIME FOR OPERATION.

6.14.5 Error Reporting

Recommended error reporting for the PREVENT ALLOW MEDIUM REMOVAL command is defined in Table 338.

Table 338 — Recommended errors for PREVENT ALLOW MEDIUM REMOVAL Command

Error	Reference
Unit Attention conditions	Table F.1
CDB or parameter list validation errors	Table F.2
Hardware failures	Table F.8

6.15 READ (10) Command

6.15.1 Introduction

The READ (10) command requests that the Drive transfer data to the Host. The most recent data value written in the addressed logical block region shall be returned.

Table 339 shows the Features associated with the READ (10) command.

Table 339 — Features Associated with the READ (10) Command

Feature Number	Feature Name	Command Requirement ¹
0010h	Random Readable	Mandatory
001Dh	MultiRead	Mandatory
001Fh	DVD Read	Mandatory
0028h	MRW	Mandatory
0029h	Enhanced Defect Reporting Feature	Mandatory
0040h	BD Read	Mandatory
0050h	HD DVD Read	Mandatory

¹The command requirement is valid only when the feature is current.

6.15.2 The CDB and Its Parameters

6.15.2.1 The CDB

The READ (10) CDB is shown in Table 340.

Table 340 — READ (10) CDB

Bit	7	6	5	4	3	2	1	0
0	OPERATION CODE (28h)							
1	Reserved		DPO	FUA	Reserved		Obsolete	
2	(MSB) Starting Logical Block Address (LSB)							
3								
4								
5								
6								
7	(MSB) Transfer Length (LSB)							
8								
9	Control							

6.15.2.2 DPO

The Disable Page Out (DPO) bit is not used by MM Drives and shall be set to zero.

6.15.2.3 FUA

A Force Unit Access (FUA) bit of one indicates that the Drive shall access the media in performing the command. The READ (10) command shall access the specified logical blocks from the media (i.e., the data is not directly retrieved from the cache). In the case where the cache contains a more recent version of a logical block than the media, the logical block shall first be written to the media.

An FUA bit of zero indicates that the Drive may satisfy the command by accessing the cache memory. For read operations, any logical blocks that are contained in the cache memory may be transferred to the Host directly from the cache memory.

6.15.2.4 Logical Block Address

The Logical Block Address field contains the LBA of the first block from which data shall be returned. If the Logical Block Address is beyond the range of recorded data, the Drive shall terminate the command with CHECK CONDITION status and SK/ASC/ASCQ values shall be set to ILLEGAL REQUEST/LOGICAL BLOCK ADDRESS OUT OF RANGE.

6.15.2.5 Transfer Length

The Transfer Length field specifies the number of contiguous logical blocks of data that shall be transferred. A Transfer Length of zero indicates that no logical blocks shall be transferred. This condition shall not be considered an error. Any other value indicates the number of logical blocks that shall be transferred.

6.15.3 Command Processing

The block size for the READ (10) command shall be 2 048 bytes. If the block size of a requested sector is not 2 048, the Drive shall:

1. Terminate the command with CHECK CONDITION status,
2. Set sense bytes SK/ASC/ASCQ to ILLEGAL REQUEST/ILLEGAL MODE FOR THIS TRACK,
3. The ILI bit in sense data byte 2 shall be set to one, and
4. Set the sense Information bytes to the LBA of the sector.

Any read by the Host to a Logical Block with a Title Key present in the sector (DVD-ROM Media Only), when the Authentication Success Flag (ASF) is set to zero, shall be blocked. The command shall be terminated with CHECK CONDITION status and SK/ASC/ASCQ values shall be set to ILLEGAL REQUEST/READ OF SCRAMBLED SECTOR WITHOUT AUTHENTICATION.

If the currently mounted medium is CD-RW with MRW formatting operating in background, DVD+RW with basic formatting operating in background, or DVD+RW with MRW formatting operating in background, the READ (10) command operation shall be as follows:

1. If any of the sectors within the range specified by the CDB are in a blank area of the media where format writing has not yet occurred, the blank sectors shall not be read and the command shall fabricate and return data as if the sectors had been format written.
2. If all of the sectors within the range specified by the CDB are in an area of the media where format writing has occurred, the command shall operate normally.

When Restricted Overwrite method is performed (Restricted Overwrite Feature (0026h) or Rigid Restricted Overwrite Feature (002Ch)), READ (10) command or READ (12) command shall be performed normally after data in buffer is written on the disc.

If Enhanced Defect Reporting Feature (0029h) is current, the Drive shall follow the setting of the PER bit and the EMCDR field in Read/Write Error Recovery Parameters Mode Page (01h). See clause 4.7.

6.15.4 Timeouts

The READ (10) command belongs to timeout group 1. If the command is terminated with CHECK CONDITION status due to a timeout, sense bytes SK/ASC/ASCQ shall be set to UNIT ATTENTION/INSUFFICIENT TIME FOR OPERATION.

6.15.5 Error Reporting

Recommended error reporting for the READ (10) command is defined in Table 341.

Table 341 — Recommended errors for READ (10) Command

Error	Reference
Unit Attention conditions	Table F.1
CDB or parameter list validation errors	Table F.2
Readiness errors	Table F.3
General media access errors	Table F.5
Read errors	Table F.6
Hardware failures	Table F.8

6.16 READ (12) Command

6.16.1 Introduction

The READ (12) command requests that the Drive transfer data to the Host. The most recent data value written in the addressed logical block shall be returned.

Table 342 shows the Features associated with the READ (12) command.

Table 342 — Features Associated with the READ (12) Command

Feature Number	Feature Name	Command Requirement ¹
001Fh	DVD Read	Mandatory
0028h	MRW	Mandatory
0029h	Enhanced Defect Reporting	Mandatory
0040h	BD Read	Mandatory
0050h	HD DVD Read	Mandatory
0107h	Real-time Streaming	Mandatory

¹The command requirement is valid only when the feature is current.

6.16.2 The CDB and Its Parameters

6.16.2.1 The CDB

The READ (12) CDB is shown in Table 343.

Table 343 — READ (12) CDB

Bit	7	6	5	4	3	2	1	0
Byte								
0	OPERATION CODE (A8h)							
1	Reserved		DPO	FUA	Reserved		Obsolete	
2	(MSB) Starting Logical Block Address (LSB)							
3								
4								
5								
6								
6	(MSB) Transfer Length (LSB)							
7								
8								
9								
10	Streaming	Reserved						
11	Control							

6.16.2.2 DPO

The Disable Page Out (DPO) bit is not used by MM Drives and shall be set to zero.

6.16.2.3 FUA

A Force Unit Access (FUA) bit of one indicates that the Drive shall access the media in performing the command. The READ (12) command shall access the specified logical blocks from the media (i.e., the data is not directly retrieved from the cache). In the case where the cache contains a more recent version of a logical block than the media, the logical block shall first be written to the media.

An FUA bit of zero indicates that the Drive may satisfy the command by accessing the cache memory. For read operations, any logical blocks that are contained in the cache memory may be transferred to the Host directly from the cache memory.

6.16.2.4 Logical Block Address

The Logical Block Address field contains the LBA of the first block from which data shall be returned. If the Logical Block Address is outside the range of recorded data, the Drive shall terminate the command with CHECK CONDITION status and SK/ASC/ASCQ values shall be set to ILLEGAL REQUEST/LOGICAL BLOCK ADDRESS OUT OF RANGE.

6.16.2.5 Transfer Length

The Transfer Length field specifies the number of contiguous logical blocks of data that shall be transferred. A Transfer Length of zero indicates that no logical blocks shall be transferred. This condition shall not be considered an error. Any other value indicates the number of logical blocks that shall be transferred.

6.16.2.6 Streaming

The Streaming bit of one specifies that the Stream playback operation shall be used for the command (see 4.8.2). The Streaming bit of zero specifies that the conventional READ operation shall be used for the command. If the Streaming bit is set to one, the WCE and RCD bits in the Caching Mode Page may be ignored. If the Streaming bit is set to one, linear replacements shall not be performed.

If Streaming bit is set to 1 and if the Drive supports Group3 timeout and if G3Enable bit in Timeout & Protect Mode Page (1Dh) is set to 1, the Drive shall terminate this command within Group 3 timeout. If G3Enable bit is set to 0, this command is categorized as Group 1 timeout.

When the Streaming bit is set to one, the FUA bit shall be set to zero. If the Streaming bit is set to one and the FUA bit is set to one, the Drive shall terminate the command with CHECK CONDITION status and SK/ASC/ASCQ values shall be set to ILLEGAL REQUEST/INVALID FIELD IN CDB.

6.16.3 Command Processing

The block size for the READ (12) command shall be 2 048 bytes. If the block size of a requested sector is not 2 048, the Drive shall:

1. Terminate the command with CHECK CONDITION status,
2. Set sense bytes SK/ASC/ASCQ to ILLEGAL REQUEST/ILLEGAL MODE FOR THIS TRACK,
3. The ILI bit in sense data byte 2 shall be set to one, and
4. Set the sense Information bytes to the LBA of the sector.

Any read by the Host to a Logical Block with a Title Key present in the sector (DVD-ROM Media Only), when the Authentication Success Flag (ASF) is set to zero shall be blocked. The command shall be terminated with CHECK CONDITION status and SK/ASC/ASCQ values shall be set to ILLEGAL REQUEST/READ OF SCRAMBLED SECTOR WITHOUT AUTHENTICATION.

If the currently mounted medium is CD-RW with MRW formatting operating in background, DVD+RW with basic formatting operating in background, or DVD+RW with MRW formatting operating in background, the READ (12) command operation shall be as follows:

- a) If any of the sectors within the range specified by the CDB are in a blank area of the media where format writing has not yet occurred, the blank sectors shall not be read and the command shall fabricate and return data as if the sectors had been format written.
- b) If all of the sectors within the range specified by the CDB are in an area of the media where format writing has occurred, the command shall operate normally.

6.16.4 Timeouts

The READ (12) command belongs to timeout group 1. If the command is terminated with CHECK CONDITION status due to a timeout, sense bytes SK/ASC/ASCQ shall be set to UNIT ATTENTION/INSUFFICIENT TIME FOR OPERATION.

If the Drive supports Group3 time-out and the G3Enable bit in Time-out & Protect Mode Page (1Dh) is set to 1, READ (12) with Streaming = 1 is re-categorized as Group 3 time-out. Refer to 4.1.9.5.

6.16.5 Error Reporting

Recommended error reporting for the READ (12) command is defined in Table 344.

Table 344 — Recommended errors for READ (12) Command

Error	Reference
Unit Attention conditions	Table F.1
CDB or parameter list validation errors	Table F.2
Readiness errors	Table F.3
General media access errors	Table F.5
Read errors	Table F.6
Hardware failures	Table F.8

6.17 READ BUFFER Command

6.17.1 Introduction

The READ BUFFER command is used in conjunction with the WRITE BUFFER command as a diagnostic function for testing memory in the device and the integrity of the service delivery subsystem. Execution of this command shall not alter the medium.

Table 345 shows the Features associated with the READ BUFFER command.

Table 345 — Features Associated with the READ BUFFER Command

Feature Number	Feature Name	Command Requirement ¹
0104h	Microcode Upgrade	Mandatory for mode = 00010b
¹ The command requirement is valid only when the feature is current.		

The READ BUFFER command is described in [SPC-3].

6.17.2 Timeouts

The READ BUFFER command belongs to timeout group 1. If the command is terminated with CHECK CONDITION status due to a timeout, sense bytes SK/ASC/ASCQ shall be set to UNIT ATTENTION/INSUFFICIENT TIME FOR OPERATION.

6.17.3 Error Reporting

Recommended error reporting for the READ BUFFER command is defined in Table 346.

Table 346 — Recommended errors for READ BUFFER Command

Error	Reference
Unit Attention conditions	Table F.1
CDB or parameter list validation errors	Table F.2

6.18 READ BUFFER CAPACITY Command

6.18.1 Introduction

During certain streamed write operations, the READ BUFFER CAPACITY command returns the Drive's total length of buffer and its length of available buffer. The Drive reports the length of the buffer during Track at Once Recording, Session at Once Recording, or Disc at once recording.

Table 347 shows the Features associated with the READ BUFFER CAPACITY command.

Table 347 — Features Associated with the READ BUFFER CAPACITY Command

Feature Number	Feature Name	Command Requirement ¹
0107h	Real-time Streaming	Mandatory. Conditional for Block bit = 1.
¹ The command requirement is valid only when the feature is current.		

6.18.2 The CDB and Its Parameters

6.18.2.1 The CDB

The READ BUFFER CAPACITY CDB is shown in Table 348.

Table 348 — READ BUFFER CAPACITY CDB

Bit Byte	7	6	5	4	3	2	1	0
0	Operation Code (5Ch)							
1	Reserved			Reserved				BLOCK
2	Reserved							
3	Reserved							
4	Reserved							
5	Reserved							
6	Reserved							
7	(MSB) Allocation Length							
8	(LSB)							
9	Control							

6.18.2.2 BLOCK

When the BLOCK bit is zero, the Host is requesting that buffer length information be reported as bytes. The BLOCK bit, if set to one, indicates that the Host is requesting buffer length information reported as blocks. If the Drive does not support the case for Block = 1, the command shall be terminated with CHECK CONDITION status and sense bytes SK/ASC/ASCQ shall be set to ILLEGAL REQUEST/INVALID FIELD IN CDB.

6.18.2.3 Allocation Length

If Allocation Length is 12 or greater, the entire Buffer Capacity structure shall be returned. If Allocation Length is less than 12, the returned data shall be truncated to that length. An Allocation Length of zero is not an error.

6.18.3 Command Processing

6.18.3.1 Reporting Available Buffer in Bytes

If the Real-time Streaming Feature is present and current, the Drive shall return the Buffer Capacity structure associated with Block = 0 (Table 349).

Table 349 — Buffer Capacity Structure, when Block = 0

Bit Byte	7	6	5	4	3	2	1	0
0	(MSB) Data Length							
1	(LSB)							
2	Reserved							
3	Reserved							
4	(MSB) Length of the Buffer							
5								
6								
7	(LSB)							
8	(MSB) Blank Length of Buffer							
9								
10								
11	(LSB)							

The Data Length field defines the number of data bytes to be transferred by the Drive. The Data Length value does not include the Data Length field itself.

The Length of Buffer indicates the whole capacity of the buffer in bytes.

The Blank Length of Buffer is the length of the unused area of the buffer in bytes. If the Real-time Streaming Feature is present, but not current, the contents of this field are not defined.

6.18.3.2 Reporting Available Buffer in Blocks

If the Real-time Streaming Feature is present and current, and the RBCB bit in the Feature Descriptor is set to one, the Drive shall return the Buffer Capacity structure associated with Block = 1 (Table 350).

Table 350 — Buffer Capacity Structure, when Block = 1

Bit Byte	7	6	5	4	3	2	1	0
0	(MSB) Data Length							
1	(LSB)							
2	Reserved							
3	Reserved							
4	Reserved							Block
5	Reserved							
6	Reserved							
7	Reserved							
8	(MSB) Available Length of Buffer							
9								
10								
11	(LSB)							

The Data Length field defines the number of data bytes to be transferred by the Drive. The Data Length value does not include the Data Length field itself.

The Available Length of Buffer field indicates the number of blocks of buffer currently available to be written to by the Host. The Drive shall be able to immediately accept at least this much data for writing. If the Available Length of Buffer becomes zero, the Drive shall begin writing. The Drive may begin writing before the Available Length of Buffer reaches zero.

6.18.4 Timeouts

The READ BUFFER CAPACITY command belongs to timeout group 1. If the command is terminated with CHECK CONDITION status due to a timeout, sense bytes SK/ASC/ASCQ shall be set to UNIT ATTENTION/INSUFFICIENT TIME FOR OPERATION.

6.18.5 Error Reporting

Recommended error reporting for the READ BUFFER CAPACITY command is defined in Table 351.

Table 351 — Recommended errors for READ BUFFER CAPACITY Command

Error	Reference
Unit Attention conditions	Table F.1
CDB or parameter list validation errors	Table F.2

6.19 READ CAPACITY Command

6.19.1 Introduction

The READ CAPACITY command provides a means for the Host to request information regarding the capacity of media currently loaded into the Drive. This capacity is reported with respect to reading operations. For capacity associated with writing operations, see 6.24, READ FORMAT CAPACITIES Command.

Table 352 shows the Features associated with the READ CAPACITY command.

Table 352 — Features Associated with the READ CAPACITY Command

Feature Number	Feature Name	Command Requirement
0010h	Random Readable	Mandatory
0020h	Random Writable	Mandatory
0025h	Write-Once	Mandatory
0026h	Restricted Overwrite	Mandatory
0027h	CD-RW CAV Write	Mandatory
0028h	MRW	Mandatory
002Ch	Rigid Restricted Overwrite	Mandatory

6.19.2 The CDB and Its Parameters

6.19.2.1 The CDB

The READ CAPACITY CDB is shown in Table 353.

Table 353 — READ CAPACITY CDB

Bit	7	6	5	4	3	2	1	0
Byte								
0	OPERATION CODE (25h)							
1	Reserved							Obsolete
2	(MSB) Logical Block Address=0000 0000h (LSB)							
3								
4								
5								
6								
7	Reserved							
8	Reserved							PMI=0
9	Control							

6.19.2.2 Logical Block Address

The Logical Block Address field is not used by MM Drives. The Drive may ignore this field.

6.19.2.3 PMI

The PMI field is not used by MM Drives and shall be set to zero.

6.19.3 Command Processing

The Drive shall respond to this command by returning eight bytes of READ CAPACITY response data. The format of response data is shown in Table 354.

Table 354 — READ CAPACITY Response Data

Bit Byte	7	6	5	4	3	2	1	0
0	Logical Block Address							
1								
2								
3								
4	Block Length in Bytes = 2 048d							
5								
6								
7								

The returned Logical Block Address is dependent upon media and format type. Table 355 shows the reporting for each MM case.

Table 355 — Logical Block Address Reporting

Media/Format	Logical Block Address
CD, non-MRW formats	If the Start address of last recorded lead-out minus 1 is a run-out block, this value is the Start address of last recorded lead-out minus 2. Otherwise, this value is the Start address of last recorded lead-out minus 1. The Logical Address calculation shall be according to the addressing method of the track that immediately precedes the lead-out. If no complete session exists on the medium, this field shall be set to zero.
CD-MRW	When LBA Space bit of MRW Mode Page is set to 0, this field is set to the Method 3 address of the last block in the Defect Managed Area. When LBA Space bit is set to 1, this field is set to the address of the last block in the General Application Area. When the format is in progress, this field shall be the last addressable LBA when formatting is completed.
DVD+MRW	When LBA Space bit of MRW Mode Page is set to 0, this field is set to the address of the last block in the User Data Area. When LBA Space bit is set to 1, this field is set to the address of the last block in the General Application Area. When the format is in progress, this field shall be the last addressable LBA when formatting is completed.
DVD, non-MRW formats	The last addressable user data block (= Last Recorded Address) in the last track of the last complete session.
HD DVD	The last addressable user data block (= Last Recorded Address) in the last track of the last complete session.
BD-ROM	The first PSN in the User Data Zone is 00100000h. The Last PSN of the User Data Zone, L, is specified in the DI. The READ CAPACITY LBA is L - 00100000h.
Unformatted BD-RE	The command shall be terminated with CHECK CONDITION status and sense bytes SK/ASC/ASCQ shall be set to either MEDIUM ERROR/MEDIUM FORMAT CORRUPTED or MEDIUM ERROR/MEDIUM NOT FORMATTED.
Formatted BD-RE	The DDS contains a field named: Last LSN of User Data Zone. The contents of that field is the READ CAPACITY LBA.
Blank BD-R	Since no sectors are readable, the LBA reported is 00000000h.
BD-R SRM+POW	The LBA of the last addressable user data block (= Last Recorded Address) in the last track of the last complete session.
BD-R RRM and BD-R SRM+POW	LBA of the last sector of the last writable Cluster in the User Data Zone. The (T)DDS contains a field named: Last LSN of User Data Zone. The contents of that field is the READ CAPACITY LBA.

In the case of MRW formats and DVD+RW, the Logical Block Address reported shall be the expected final value when BG formatting is in progress and not completed (i.e., when the READ DISC INFORMATION command response for BG format status is non-zero).

For all MM media and format types, the Block Length shall be reported, in bytes, as 2 048.

6.19.4 Timeouts

The READ CAPACITY command belongs to timeout group 1. If the command is terminated with CHECK CONDITION status due to a timeout, sense bytes SK/ASC/ASCQ shall be set to UNIT ATTENTION/INSUFFICIENT TIME FOR OPERATION.

6.19.5 Error Reporting

Recommended error reporting for the READ CAPACITY command is defined in Table 356.

Table 356 — Recommended errors for READ CAPACITY Command

Error	Reference
Unit Attention conditions	Table F.1
CDB or parameter list validation errors	Table F.2
Readiness errors	Table F.3
General media access errors	Table F.5
Read errors	Table F.6

6.20 READ CD Command

6.20.1 Introduction

The READ CD command provides a method for accessing most fields within any CD sector. This command has a large variety of execution outcomes due the numerous parameters.

Table 357 shows the Features associated with the READ CD command.

Table 357 — Features Associated with the READ CD Command

Feature Number	Feature Name	Command Requirement ¹
001Dh	MultiRead	Mandatory
001Eh	CD Read	Mandatory
¹ The command requirement is valid only when the feature is current.		

6.20.2 The CDB and Its Parameters

6.20.2.1 The CDB

The READ CD CDB is shown in Table 358.

Table 358 — READ CD CDB

Bit Byte	7	6	5	4	3	2	1	0
0	Operation Code (BEh)							
1	Reserved			Expected Sector Type			DAP	Obsolete
2	(MSB) Starting Logical Block Address (LSB)							
3								
4								
5								
6	(MSB) Transfer Length (LSB)							
7								
8								
9	Main Channel Selection Bits				C2 Error Information		Reserved	
	SYNC	Header Codes	User Data	EDC & ECC				
10	Reserved				Sub-channel Selection Bits			
11	Control							

6.20.2.2 Expected Sector Type

The Expected Sector Type field (Table 359) is used to restrict reading to a specific CD sector type. A transfer operation is terminated as soon as data is encountered that does not match one of those specified in the sector type field of the command. The sector/sectors that do not match shall not be transferred to the Host.

Table 359 — Expected Sector type field bit definitions

Sector Type	Definition	Description	Requirement
000b	All types	No checking of the data type is performed. If there is a transition between CD data and CD-DA data, the command shall be terminated with a CHECK CONDITION status and sense bytes SK/ASC/ASCQ shall be set to ILLEGAL REQUEST/ILLEGAL MODE FOR THIS TRACK.	Mandatory
001b	CD-DA	Only IEC 908 (CD-DA) sectors shall be returned. If any other sector type is encountered, the command shall be terminated with a CHECK CONDITION status and sense bytes SK/ASC/ASCQ shall be set to ILLEGAL REQUEST/ILLEGAL MODE FOR THIS TRACK.	Mandatory
010b	Mode 1	Only sectors with a user data field of 2 048 bytes shall be returned. If any other sector type is encountered, the command shall be terminated with a CHECK CONDITION status and sense bytes SK/ASC/ASCQ shall be set to ILLEGAL REQUEST/ILLEGAL MODE FOR THIS TRACK.	Mandatory
011b	Mode 2 formless	Only sectors with the expanded user data field (2 336 bytes) shall be returned. If any other sector type is encountered, the command shall be terminated with a CHECK CONDITION status and sense bytes SK/ASC/ASCQ shall be set to ILLEGAL REQUEST/ILLEGAL MODE FOR THIS TRACK.	Optional
100b	Mode 2 form 1	Only sectors that have a user data field of 2 048 bytes shall be returned. If any other sector type is encountered, the command shall be terminated with a CHECK CONDITION status and sense bytes SK/ASC/ASCQ shall be set to ILLEGAL REQUEST/ILLEGAL MODE FOR THIS TRACK.	Mandatory
101b	Mode 2 form 2	Only sectors that have a user data field of 2 324 bytes shall be returned. If any other sector type is encountered, the command shall be terminated with a CHECK CONDITION status and sense bytes SK/ASC/ASCQ shall be set to ILLEGAL REQUEST/ILLEGAL MODE FOR THIS THIS TRACK.	Mandatory
110b-111b	Reserved	—	—

6.20.2.3 DAP

Digital Audio Play (DAP) is used to control error concealment when the data being read is CD-DA. If the data being read is not CD-DA, DAP shall be ignored. If the data being read is CD-DA and DAP is set to zero, then the user data returned to the Host should not be modified by flaw obscuring mechanisms such as audio data mute and interpolate. If the data being read is CD-DA and DAP is set to one, then the user data returned to the Host should be modified by flaw obscuring mechanisms such as audio data mute and interpolate.

6.20.2.4 Starting Logical Block Address

The Starting Logical Block Address field specifies the logical block that the read operation shall begin.

6.20.2.5 Transfer Length

The Transfer Length field specifies the number of contiguous logical blocks of data that shall be transferred. A Transfer Length field of zero indicates that no transfer of data shall occur. This condition shall not be considered an error.

6.20.2.6 Main Channel Selection Bits

The Main Channel Field Selection Bits identify fields of the 2 352 bytes of main channel that the Host is requesting for each sector:

When Sync is zero, the sync field of data sectors shall not be included in the read data stream. If Sync is one, the 12-byte sync field (Figure 16) of data sectors shall be included in the read data stream.

The Header Codes refer to the sector header and the sub-header that is present in mode 2 formed sectors as shown in Table 360.

Table 360 — Header Codes

Header Code	Field Specification
00b	No header information shall be transferred.
01b	The 4-byte sector header (Table 19) of data sectors shall be transferred,
10b	The 8-byte sector sub-header (Table 24) of mode 2 formed sectors shall be transferred.
11b	Both sector header and sub-header (12 bytes) shall be transferred. Header shall be transferred first.

When User Data is zero, the User Data field shall not be included in the read data stream. If User Data is one, the User Data field shall be included in the read data stream. The size of the user data field varies according to sector type.

When EDC & ECC is zero, no field that follows the user data field shall be included in the read data stream. If EDC & ECC is one, all fields that follow the user data field shall be included in the read data stream. The size of the EDC/ECC field varies according to sector type.

A few problems arise:

- a. The main channel fields selected may not actually be present in a given CD sector.
- b. It is not practical to provide data from 2 or more non-contiguous fields.

In these cases, the combination may be either considered invalid or mapped to a valid combination according to the following rules:

1. If no field is requested, then regardless of sector type, no data shall be transferred. This shall not be considered an error.
2. If the sector is CD-DA and any non-zero number of fields is requested, then the entire 2 352 bytes of main channel shall be transferred.
3. If the sector is a CD data type and the Host has selected fields that are non-contiguous for that sector type, the command shall be terminated with CHECK CONDITION status and sense bytes SK/ASC/ASCQ shall be set to ILLEGAL REQUEST/INVALID FIELD in CDB.

Table 361 shows a complete mapping of Main Channel Selection bits.

Table 361 — Main Channel Selection and Mapped Values

Main Channel Selection	Main Channel Selection Value ¹	Requirement ²	CD-DA	Mode 1	Mode 2 Formless	Mode 2 Form 1	Mode 2 Form 2
If the Host selects these fields	—	—	The Drive shall map the selection to this value.				
No fields	00h	M	00h	00h	00h	00h	00h
EDC/ECC Only	08h	O	10h	08h	10h	08h	08h
User Data	10h	M	10h	10h	10h	10h	10h
User Data + EDC/ECC	18h	O	10h	18h	10h	18h	18h
Header	20h	O	10h	20h	20h	20h	20h
Header Only + EDC/ECC	28h	O	10h	Invalid	Invalid	Invalid	Invalid
Header & User Data	30h	O	10h	30h	30h	Invalid	Invalid
Header & User Data + EDC/ECC	38h	O	10h	38h	30h	Invalid	Invalid
Sub-Header Only	40h	O	10h	00h	00h	40h	40h
Sub-Header Only + EDC/ECC	48h	O	10h	Invalid	Invalid	Invalid	Invalid
Sub-Header & user data	50h	O	10h	10h	10h	50h	50h
Sub-Header & user data + EDC/ECC	58h	O	10h	18h	10h	58h	58h
All Headers Only	60h	O	10h	20h	20h	60h	60h
All Headers Only + EDC/ECC	68h	O	10h	Invalid	Invalid	Invalid	Invalid
All Headers & user data	70h	O	10h	30h	30h	70h	70h
All Headers & user data + EDC/ECC	78h	O	10h	38h	38h	78h	78h
Sync Only	80h	O	10h	80h	80h	80h	80h
Sync + EDC/ECC	88h	O	10h	Invalid	Invalid	Invalid	Invalid
Sync & User Data	90h	O	10h	Invalid	Invalid	Invalid	Invalid
Sync & User Data + EDC/ECC	98h	O	10h	Invalid	Invalid	Invalid	Invalid
Sync & Header Only	A0h	O	10h	A0h	A0h	A0h	A0h
Sync & Header Only + EDC/ECC	A8h	O	10h	Invalid	Invalid	Invalid	Invalid
Sync & Header + User Data	B0h	O	10h	B0h	B0h	Invalid	Invalid
Sync & Header + User Data + EDC/ECC	B8h	O	10h	B8h	B0h	Invalid	Invalid
Sync & Sub Header Only	C0h	O	10h	Invalid	Invalid	Invalid	Invalid
Sync & Sub Header Only + EDC/ECC	C8h	O	10h	Invalid	Invalid	Invalid	Invalid
Sync & Sub Header & User Data	D0h	O	10h	Invalid	Invalid	Invalid	Invalid
Sync & Sub Header & User Data + EDC/ECC	D8h	O	10h	Invalid	Invalid	Invalid	Invalid
Sync & All Headers Only	E0h	O	10h	A0h	A0h	E0h	E0h
Sync & All Headers Only + EDC/ECC	E8h	O	10h	Invalid	Invalid	Invalid	Invalid
Sync & All Headers & user data	F0h	O	10h	B0h	B0h	F0h	F0h
Sync & All Headers & user data + EDC/ECC	F8h	M	10h	B8h	B0h	F8h	F8h

¹This is CDB Byte 9 logically ANDed with F8h.
²M = Mandatory, O = Optional

6.20.2.7 C2 Error Information

The C2 Errors code (Table 362) provides for the inclusion of fabricated information based upon the results of C2 error correction (on main channel).

Table 362 — C2 Errors Codes

C2 Errors Code	Number of Bytes	Description
00b	0	No error information is returned.
01b	294	A bit is associated with each of the 2 352 bytes of main channel where: 0 = No C2 error and 1 = C2 error. This results in 294 bytes of C2 error bits. Return the 294 bytes of C2 error bits in the data stream.
10b	296	The Block Error Byte = Logical OR of all of the 294 bytes of C2 error bits. First return Block Error Byte, then a pad byte of zero and finally the 294 bytes of C2 error bits.
11b	—	Reserved

6.20.2.8 Sub-channel Selection bits

The Sub-channel Selection bits (Table 363) allow the Host to request that certain sub-channel information be included in the data stream.

Table 363 — Sub-Channel Selection Field Values

Sub-Channel Selection Bits	Meaning of Host Request	Field Size in Bytes
000b	No Sub-channel data shall be returned.	0
001b	RAW P-W Sub-channel data shall be returned.	96
010b	Formatted Q sub-channel data shall be transferred (See Table 364).	16
011b	Reserved	—
100b	Corrected and de-interleaved R-W sub-channel data shall be transferred.	96
101b	Reserved	—
110b	Reserved	—
111b	Reserved	—

The Host may select multiple fields in CDB bytes 9 and 10. The Drive shall transfer the selected fields in the following order:

- | | | | |
|----|------------|-----|----------------------|
| 1. | Sync | 6. | Mode 1 pad |
| 2. | Header | 7. | ECC parity |
| 3. | Sub-header | 8. | C2 block error bytes |
| 4. | User Data | 9. | C2 Error flags |
| 5. | EDC | 10. | Sub-channel |

6.20.3 Command Processing

6.20.3.1 Main Channel Field Formats

6.20.3.1.1 Sync Field

Synchronization for CD-DA sectors is performed by scanning sub-channel, so there is no sync pattern in the main channel of CD-DA.

Synchronization for CD data sectors is performed by scanning for the sync pattern in the main channel. This 12-byte pattern is identical for all types of data sectors. See Figure 16 in the models clause.

6.20.3.1.2 Headers

The specific sector address identification is based upon its synchronization method. A CD-DA sector address is identified by the Q sub-channel that follows its sub-channel synchronization pattern. So, a CD-DA sector does not contain a header in main channel.

Data sectors are synchronized in main channel, so the address identification is also in main channel: the header. The 4-byte header has the same format for all data sector types. See Table 19 in the models clause.

Only Mode 2 formed data types have a sub-header. The sub-header is 4 bytes in length, but is repeated so that it appears as the 8 bytes that immediately follows the sector header. See Table 24 in the models clause.

6.20.3.1.3 User Data

The user data is defined according to Sector Type field of the CDB:

For CD-DA, User Data is all 2 352 bytes of main channel.

For data Mode 1, User Data is 2 048 bytes beginning at offset 16 of the 2 352 bytes of main channel (see Table 21 in the models clause.).

For data Mode 2 formless, User Data is 2 336 bytes beginning at offset 16 of the 2 352 bytes of main channel (see Table 22).

For data Mode 2, form 1, User Data is 2 048 bytes beginning at offset 24 of the 2 352 bytes of main channel (see Table 23).

For data Mode 2, form 2, User Data is 2 324 bytes beginning at offset 24 of the 2 352 bytes of main channel (see Table 25).

6.20.3.1.4 EDC and ECC

The presence and size of EDC redundancy or ECC parity within the 2 352 bytes of main channel is defined according to sector type:

CD-DA sectors have neither EDC redundancy nor ECC parity.

Data Mode 1 sectors have 288 bytes of EDC redundancy, Pad, and ECC parity beginning at offset 2 064 of the 2 352 bytes of main channel (see Table 21).

Data Mode 2 formless sectors have neither EDC redundancy nor ECC parity (see Table 22).

Data Mode 2 form 1 sectors have 280 bytes of EDC redundancy and ECC parity beginning at offset 2 072 of the 2 352 bytes of main channel (see Table 23).

Data Mode 2 form 2 sectors optionally have 4 bytes of EDC redundancy beginning at offset 2 348 of the 2 352 bytes of main channel (see Table 25).

6.20.3.1.5 C2 Errors

A bit is associated with each of the 2 352 bytes of main channel where: 0 = No C2 error and 1 = C2 error. The resulting bit field is ordered exactly as the main channel bytes. Each 8-bit boundary defines a byte of flag bits.

6.20.3.2 Sub-Channel Field Formats

6.20.3.2.1 Overview

Sub-channel data may be collected into 96 bytes of P-W sub-channel as it is separated from main channel during the read process. P and Q sub-channel is typically copied elsewhere for independent construction of 12 bytes each of P and Q sub-channel. See 4.2.1.3.

6.20.3.2.2 RAW P-W Sub-channel

Raw P-W sub-channel is the 96 bytes of sub-channel returned in the order received from the disc surface.

6.20.3.2.3 P and Q Sub-Channel

P sub-channel is recorded with the same bit value in each sub-channel byte. Due to potential media flaws and the lack of error correction, the most accurate method of determining P is by a redundancy vote.

Q sub-channel has a wide variety of formats (see 4.2.3.4 through 4.2.3.7), however all formats are based on one basic format of 10 bytes of data with 2 bytes of CRC. Both P and Q sub-channel are accessible via the READ CD command in a format shown in Table 364.

Table 364 — Formatted Q- Subchannel Data

Byte	Description
0	Control (4 MS bits), ADR (4 LS bits)
1	Track number
2	Index number
3	Min
4	Sec
5	Frame
6	ZERO
7	AMIN
8	ASEC
9	AFRAME
10	CRC or 00h (CRC is optional)
11	CRC or 00h (CRC is optional)
12	00h (pad)
13	00h (pad)
14	00h (pad)
15	Bits 6-0 shall be set to zero, Bit 7 may (optionally) contain the P Sub-channel value. If P sub-channel reporting is not supported, then bit 7 shall be set to zero.

6.20.3.2.4 Corrected and De-interleaved R-W Sub-channel

R-W sub-subchannel may contain graphical information (CD+G) or music controls (CD+MIDI). These forms may occur only on CD audio tracks.

The data from each sector is separated into 24-byte “packs” for de-interleaving. The interleaving is 8/24, so 3 contiguous sectors are needed to deinterleave the first pack. Consequently, in order to deliver the correct number of sector sets of R-W sub-channel, the Drive shall include an additional 2 sectors internally.

Once deinterleave has been performed, each pack has Reed-Solomon correction applied and resulting data are sent to the Host in groups of 3 packs – 96 bytes.

For information on deinterleaving and error correction of R-W sub-channel, see System Description Compact Disc Digital Audio Addendum: R-W Sub-channels.

6.20.3.2.5 CD-Text

CD-Text may appear in CD audio tracks and the lead-in of a CD audio disc. CD-Text is packed, but the processing of the data is slightly different.

When the Starting Logical Block Address is set to F000 0000h and P-W raw data is selected, the Drive returns P-W raw data from the Lead-in area. If there is no data recorded in the Lead-in area, the command shall be

terminated with CHECK CONDITION status and set the values of SK/ASC/ASCQ to ILLEGAL REQUEST/ILLEGAL MODE FOR THIS TRACK or ILLEGAL REQUEST/INCOMPATIBLE MEDIUM INSTALLED.

If the Starting Logical Block Address is set to FFFF FFFFh after the above command, the Sub-channel data shall be returned from the current location within the Lead-in area. It is the responsibility of the Host to convert this data to CD-TEXT format without losing streaming.

For information on deinterleaving and error correction of R-W sub-channel, see System Description Compact Disc Digital Audio Addendum: CD-TEXT.

6.20.4 Timeouts

The READ CD command belongs to timeout group 1. If the command is terminated with CHECK CONDITION status due to a timeout, sense bytes SK/ASC/ASCQ shall be set to UNIT ATTENTION/INSUFFICIENT TIME FOR OPERATION.

6.20.5 Error Reporting

Recommended error reporting for the READ CD command is defined in Table 365.

Table 365 — Recommended errors for READ CD Command

Error	Reference
Unit Attention conditions	Table F.1
CDB or parameter list validation errors	Table F.2
Readiness errors	Table F.3
General media access errors	Table F.5
Read errors	Table F.6
Hardware failures	Table F.8

6.21 READ CD MSF Command

6.21.1 Introduction

The READ CD MSF command provides a method for accessing most fields within any CD sector. This command is valuable for reading CD digital audio.

Table 366 shows the Features associated with the READ CD MSF command.

Table 366 — Features Associated with the READ CD MSF Command

Feature Number	Feature Name	Command Requirement
001Eh	CD Read	Mandatory
0028h	MRW	Recommended for CD-MRW
NOTE 1: The command requirement is valid only when the feature is current.		

6.21.2 The CDB and Its Parameters

6.21.2.1 The CDB

The READ CD MSF CDB is shown in Table 367.

Table 367 — READ CD MSF CDB

Bit Byte	7	6	5	4	3	2	1	0
0	OPERATION CODE (B9h)							
1	Reserved			Expected Sector Type			DAP	Reserved
2	Reserved							
3	Starting M Field							
4	Starting S Field							
5	Starting F Field							
6	Ending M Field							
7	Ending S Field							
8	Ending F Field							
9	Main Channel Selection Bits					C2 Errors		Reserved
	SYNC	Header Codes		User Data	EDC & ECC			
10	Reserved					Sub-channel Selection Bits		
11	Control							

6.21.2.2 Expected Sector Type

See 6.20.2.2 for the definition of the Expected Sector Type field.

6.21.2.3 DAP

See 6.20.2.3 for the definition of the DAP field.

6.21.2.4 Starting M, Starting S, and Starting F Fields

The Starting M field, the Starting S field, and the Starting F field specify the absolute MSF address where the Read operation shall begin. The Starting MSF shall not begin earlier than the start of the first lead-in on the disc.

6.21.2.5 Ending M, Ending S, and Ending F Fields

The Ending M field, the Ending S field, and the Ending F field specify the absolute MSF address where the Read operation shall end. The Ending MSF shall not end later than 1.5 minutes beyond the start address of the last lead-out of the disc.

All contiguous sectors between the starting and ending MSF addresses shall be read.

Note 17. Reading across some CD structural boundaries may result in data errors.

If the Starting MSF Address is not found, the command shall be terminated with CHECK CONDITION status and set the values of SK/ASC/ASCQ to ILLEGAL REQUEST/ INVALID FIELD IN CDB.

If the Starting MSF Address is equal to the Ending MSF Address, no read operation occurs. This shall not be considered an error.

If the Starting MSF Address is greater than the Ending MSF Address, the command shall be terminated with CHECK CONDITION status and set the values of SK/ASC/ASCQ to ILLEGAL REQUEST/ INVALID FIELD IN CDB.

6.21.2.6 Main Channel Selection bits

See 6.20.2.6 for the definition of the Main Channel Selection bits field.

6.21.2.7 C2 Error Information

See 0 for the definition of the C2 Error Information field.

6.21.2.8 Sub-channel Selection bits

See 6.20.2.8 for the definition of the Sub-channel Selection bits field.

6.21.3 Command Processing

This command operates identically to the READ CD command (6.20) with the exception of how the Host selects the address range.

6.21.4 Timeouts

The READ CD MSF command belongs to timeout group 1. If the command is terminated with CHECK CONDITION status due to a timeout, sense bytes SK/ASC/ASCQ shall be set to UNIT ATTENTION/INSUFFICIENT TIME FOR OPERATION.

6.21.5 Error Reporting

Recommended error reporting for the READ CD MSF command is defined in Table 368.

Table 368 — Recommended errors for READ CD MSF Command

Error	Reference
Unit Attention conditions	Table F.1
CDB or parameter list validation errors	Table F.2
Readiness errors	Table F.3
General media access errors	Table F.5
Read errors	Table F.6
Hardware failures	Table F.8

6.22 READ DISC INFORMATION Command

6.22.1 Introduction

The READ DISC INFORMATION command allows the Host to request information about the currently mounted MM disc. When this command is required by an implemented Feature, the command shall always function, even if that Feature's Current bit becomes zero.

Table 369 shows the Features associated with the READ DISC INFORMATION command.

Table 369 — Features Associated with the READ DISC INFORMATION Command

Feature Number	Feature Name	Command Requirement
001Dh	Multi-Read	Mandatory
0021h	Incremental Streaming Writable	Mandatory
0026h	Restricted Overwrite	Mandatory
0027h	CD-RW CAV Write	Mandatory
0028h	MRW	Mandatory
0029h	Enhanced Defect Reporting	Mandatory
002Ah	DVD+RW	Mandatory (when Write bit is set to one)
002Bh	DVD+R	Mandatory (when Write bit is set to one)
002Ch	Rigid Restricted Overwrite	Mandatory
002Dh	CD Track at once	Mandatory
002Eh	CD Mastering	Mandatory
002Fh	DVD-R/-RW Write	Mandatory
003Bh	DVD+R DL	Mandatory
0051h	HD DVD Write	Mandatory for HD DVD-R

6.22.2 The CDB and Its Parameters

The READ DISC INFORMATION CDB is shown in Table 370.

Table 370 — READ DISC INFORMATION CDB

Bit	7	6	5	4	3	2	1	0	
0	Operation Code (51h)								
1	Reserved					Data Type			
2	Reserved								
3	Reserved								
4	Reserved								
5	Reserved								
6	Reserved								
7	Allocation Length								
8	(MSB)							(LSB)	
9	Control Byte								

6.22.2.1 Data Type

When a disc is present, Data Type defines the specific information requested. Defined data types are shown in Table 371.

Table 371 — Disc Information Data Types

Data Type	Returned Data
000b	Standard Disc Information
001b	Track Resources Information
010b	POW Resources Information
011b - 111b	Reserved

If the Drive does not support the requested Data Type for the currently mounted medium, the command shall be terminated with CHECK CONDITION status and sense bytes SK/ASC/ASCQ shall be set to ILLEGAL REQUEST/INVALID FIELD IN CDB.

If Data Type is 010b and the currently mounted disc does not support POW, the command shall be terminated with CHECK CONDITION status and sense bytes SK/ASC/ASCQ shall be set to ILLEGAL REQUEST/INVALID FIELD IN CDB.

6.22.2.2 Allocation Length

The number of Disc Information bytes returned is limited by the Allocation Length parameter of the CDB. An Allocation Length of zero shall not be considered an error. If the Allocation Length is greater than the amount of available Disc Information Data, only the available data is transferred.

6.22.3 Command Processing

6.22.3.1 Data Type 000b: Standard Disc Information

The Drive shall gather information about the medium, format it as shown in Table 372, and transfer to the Host, limited by the Allocation Length.

Table 372 — Disc Information Block

Bit Byte	7	6	5	4	3	2	1	0
0	(MSB) Disc Information Length							
1	(LSB)							
2	Disc Information Data Type = 000b		Erasable	State of last Session		Disc Status		
3	Number of First Track on Disc							
4	Number of Sessions (Least Significant Byte)							
5	First Track Number in Last Session (Least Significant Byte)							
6	Last Track Number in Last Session (Least Significant Byte)							
7	DID_V	DBC_V	URU	DAC_V	Reserved	Dbit	BG Format Status	
8	Disc Type							
9	Number of Sessions (Most Significant Byte)							
10	First Track Number in Last Session (Most Significant Byte)							
11	Last Track Number in Last Session (Most Significant Byte)							
12	(MSB)							
...	Disc Identification							
15	(LSB)							
16	(MSB)							
...	Last Session Lead-in Start Address							
19	(LSB)							
20	(MSB)							
...	Last Possible Lead-out Start Address							
23	(LSB)							
24	(MSB)							
...	Disc Bar Code							
31	(LSB)							
32	Disc Application Code							
33	Number of OPC Tables							
34 – n	OPC Table Entries							

6.22.3.2 Disc Information Length

The Disc Information Length is the number of bytes Disc Information available. The Disc Information Length excludes itself. The value is $32 + 8 * (\text{Number of OPC Tables})$.

6.22.3.3 Erasable Bit

The Erasable bit, when set to one, indicates that CD-RW, DVD-RAM, DVD-RW, DVD+RW, HD DVD-RAM, or BD-RE media is present and the Drive is capable of writing the media. If the Erasable bit is set to zero, then either the medium is not erasable or the Drive is unable to write the media.

6.22.3.4 State of Last Session

The State of Last Session field (Table 373) specifies the recorded state of the last session, regardless of the number of sessions on the disc.

Table 373 — State of Last Session

Session State	Definition
00b	Empty Session
01b	Incomplete Session ¹
10b	Reserved / Damaged Session (Valid only for DVD-R/-RW media)
11b	Complete Session ² (valid only for Disc Status = 10b or 11b)

¹When a disc is DVD-RW in restricted overwrite mode and the last session is in the Intermediate State, 01b is returned.
²Non-blank DVD+RW reports 11b.

6.22.3.5 Disc Status

The Disc Status field (Table 374) indicates the recorded status of the disc. A Drive that does not have the ability to write the inserted medium shall return only COMPLETE (10b) status.

Table 374 — Disc Status

Status	Definition	Description
00b	Empty Disc	A recordable disc is present and is either logically or physically blank.
01b	Incomplete Disc ¹	The currently mounted disc is recorded/recordable serially in sessions. The last session is either blank or partially recorded.
10b	Finalized Disc ²	The currently mounted disc is recorded/recordable serially in sessions. The last session is closed and there is no possibility of appending a new session.
11b	Others	The currently mounted disc supports only random access writing and is not recordable serially in multiple sessions.

¹When a disc is DVD-RW in restricted overwrite mode and the last session is Intermediate state, 01b is returned.
²Some ReWritable media may allow the last session to be grown via the FORMAT UNIT command.

6.22.3.6 Number of First Track on Disc

The Number of First Track on Disc is the track number of the logical track that contains LBA 0. The value reported is based upon media type and recorded status:

- For CD-ROM the value is the smallest track number recorded in the first TOC on the disc.
- For CD-R/RW recorded as ROM (i.e., the PMA is blank, but the first TOC is written), the value is the smallest track number recorded in the first TOC on the disc.
- For CD-R/RW where the PMA is not blank, the value is the smallest track number recorded in the PMA.
- For CD-R/RW where the PMA is blank and the first TOC on the disc is also blank, the value is one (1).
- For all other media regardless of recording status, the value is one (1).

6.22.3.7 First Track Number in Last Session

First Track Number in Last Session (bytes 5 & 10) is the track number of the first logical track in the last session. This includes the incomplete track.

6.22.3.8 Last Track Number in Last Session

Last Track Number in Last Session (bytes 6 & 11) is the track number of the last logical track in the last session. This includes the incomplete track.

6.22.3.9 DID_V Bit

The DID_V (Disc ID Valid) bit, when set to one, indicates that the Disc Identification field is valid.

6.22.3.10 DBC_V Bit

The DBC_V (Disc Bar Code Valid bit, when set to one, indicates that the Disc Bar Code field (bytes 24 through 31) is valid.

6.22.3.11 URU Bit

The URU (Unrestricted Use Disc) bit may be zero for special use CD-R, CD-RW, or DVD-R, medium. For all other media types, URU shall be set to one. When URU is zero, the mounted disc is defined for restricted use. Recording to a restricted use disc, required the appropriate Host Application code set in the Write Parameters Page. When URU is set to one, the mounted medium has unrestricted write use.

6.22.3.12 DAC_V

DAC_V indicates the validity of the Disc Application Code in byte 32. If DAC_V is set to zero, then the Disc Application Code is not valid. If DAC_V is set to one, the Disc Application Code is valid.

6.22.3.13 Dbit

If the disc is MRW formatted or MRW formatting (state = 01b, 10b, or 11b), then bit 2 of byte 7 (Dbit) is a copy of the "dirty bit" from the defect table. If Dbit is set to zero, then the MRW structures are current. If Dbit is set to one, then the MRW structures may not be current. When BG format status = 00b, Dbit shall be set to zero.

6.22.3.14 BG Format Status

The BG format status is the background format status of the mounted disc (See Table 375). Drives that report the Formattable Feature and either the MRW Feature or the DVD+RW Feature, or both are required to implement Background format. For all other Drives, this field shall be 00b.

Table 375 — Background Format Status Codes

BG format status	Meaning
00b	At least one of the following is true: <ol style="list-style-type: none"> 1. The disc is neither CD-RW nor DVD+RW. 2. The disc is CD-RW, it is not formatted as CD-MRW. 3. If the disc is DVD+RW, it is blank.
01b	A background format was started but is not currently running and is not complete.
10b	A background format is in progress. A format has been started or restarted and is not yet completed.
11b	Background formatting has completed.

6.22.3.15 Disc Type

The Disc Type field is associated only with CD media types. For all other media types, this field shall contain 00h. The Disc Type field specifies the type of data recorded on the disc. The Disc Type shall be obtained from the PMA or from the TOC of the first session. The discovery sequence is as follows:

1. Initialize Disc Type to FFh.
2. If a Disc ID item is written in the PMA, replace with the Disc Type field from that item.
3. If the disc is COMPLETE, replace with Session Format from the first Session. Otherwise, scan all complete sessions for a session that contains at least one data track. If found replace with the Session Format field.

Valid Disc Types are shown in Table 376.

Table 376 — Disc Type Field

Disc Type Code	Disc Type
00h	CD-DA or CD-ROM Disc
10h	CD-I Disc
20h	CD-ROM XA Disc
FFh	Undefined
All Other Values	Reserved

6.22.3.16 Disc Identification Number

For CD-R/RW, the Disc Identification number recorded in the PMA is returned. The Disc Identification Number is recorded in the PMA as a six-digit BCD number. It is returned in the Disc Information Block as a 32 bit binary integer.

This value should be zero filled for all other media types.

6.22.3.17 Last Session Lead-in Start Address

The Last Session Lead-in Start Address field is dependent on medium and recorded status:

- b) For CD-R/RW media the Last Session Lead-in Start Address is the MSF format address of where the next Lead-in shall be recorded. If the disc has complete status, then the value returned shall be FFh, FFh, FFh, FFh.
- c) For DVD+R media the Last Session Lead-in Start Address is the LBA of where the next Intro shall be recorded. If the disc has complete status, then the value returned shall be FFFFFFFFh.
- d) For all other media types, this field shall be filled with zeros.

6.22.3.18 Last Possible Lead-out Start Address

The Last Possible Lead-out Start Address field is dependent on medium and recorded status:

- a) For CD-R/RW the Last Possible Lead-out Start Address is the MSF format address found in the ATIP of the disc's lead-in. If the disc is Complete, the Last Possible Lead-out Start Address shall be FFh:FFh:FFh:FFh MSF.
- b) If the media is according to [CD-Ref10], the address given shall be Start Time of Additional Capacity + Capacity Extension – expected Lead-out Size, where expected lead-out size is 90 seconds for single session discs and 30 seconds for discs with two or more sessions.
- c) For DVD+R media the Last Possible Lead-out Start Address is the LBA found in the ADIP of the disc's lead-in. If the disc is Complete, the Last Possible Lead-out Start Address shall be FFFFFFFFh.
- d) For all other media types, this field shall be filled with zeros.

6.22.3.19 Disc Bar Code

For CD, the Disc Bar Code field contains the hexadecimal value of the bar code if the Drive has the ability to read Disc Bar Code and a bar code is present.

For all other media this field should be set to zeros.

6.22.3.20 Disc Application Code

Disc Application Code shall be the value discovered on the disc. If the disc has no Disc Application Code, then the contents shall be set to zero.

6.22.3.21 OPC Table

An OPC (Optimum Power Calibration) Table is attached only if the values are known for the disc. Since OPC values are likely to be different for different recording speeds, each table entry is associated with a recording speed. For DVD-R/-RW, the use of OPC tables is vendor specific.

The format of an OPC Table is shown in Table 377. Speed is in kbytes per second. The OPC Value field is associated with the speed specified in the speed field, and its content is vendor specific.

Table 377 — OPC Table Entry

Bit Byte	7	6	5	4	3	2	1	0	
0	(MSB)				Speed				
1					(kbytes per second)				(LSB)
2	OPC Values								
3									
4									
5									
6									
7									

6.22.3.22 Data Type 001b: Track Resources Information

The format of the Track Resources Information is shown in Table 378.

Table 378 — Track Resources Information Block

Bit Byte	7	6	5	4	3	2	1	0
0	(MSB) Disc Information Length = 10							
1	(LSB)							
2	Disc Information Data Type = 001b				Reserved			
3	Reserved							
4	(MSB) Maximum possible number of the Tracks on the disc							
5	(LSB)							
6	(MSB) Number of the assigned Tracks on the disc							
7	(LSB)							
8	(MSB) Maximum possible number of appendable Tracks on the disc							
9	(LSB)							
10	(MSB) Current number of appendable Tracks on the disc							
11	(LSB)							

The Disc Information Length specifies the number of bytes that follow the Disc Information Length. For data type 001b, the Disc Information Length is 10.

The Maximum Possible Number of Tracks on the Disc varies according to the currently mounted media. For example, this number is 99 on CD and 7 927 on BD-R.

The Number of the assigned Tracks on the disc is the current number of defined tracks. On the disc.

The Maximum possible number of appendable Tracks on the disc is the maximum number of tracks that are permitted to be concurrently open. This number varies according to the currently mounted media. For example, on CD this number is 99, while on BD-R this number is 16.

The Current number of appendable Tracks on the disc is the number of currently open Logical Tracks.

6.22.3.23 Data Type 010b: POW Resources Information

The format of the POW Resources Information is shown in Table 379. The POW Resources Information Block is reported only when the BD-R Pseudo-Overwrite (POW) Feature is present and current.

Table 379 — POW Resources Information Block

Bit Byte	7	6	5	4	3	2	1	0
0	(MSB) Disc Information Length = 14							
1	(LSB)							
2	Disc Information Data Type = 010b				Reserved			
3	Reserved							
4	(MSB)							
5	Remaining POW Replacements							
6								
7								
7								
8	(MSB)							
9	Remaining POW Reallocation Map Entries							
10								
11								
11								
12	(MSB)							
13	Number of Remaining POW Updates							
14								
15								
15								

The Disc Information Length specifies the number of bytes that follow the Disc Information Length. For data type 010b, the Disc Information Length is 14.

The Remaining POW Replacements is the sum of all the Free Blocks fields of all the Track Information Blocks (See 6.26.3.15) divided by the number of Logical Blocks in a Cluster (32). This is the number of potential POWs that may be performed.

Remaining POW Reallocation Map Entries is the number of unused entries in the TDFL.

Number of Remaining POW Updates is the number of unused Clusters in the TDMA.

6.22.4 Timeouts

The READ DISC INFORMATION command belongs to timeout group 1. If the command is terminated with CHECK CONDITION status due to a timeout, sense bytes SK/ASC/ASCQ shall be set to UNIT ATTENTION/INSUFFICIENT TIME FOR OPERATION.

6.22.5 Error Reporting

Recommended error reporting for the READ DISC INFORMATION command is defined in Table 380.

Table 380 — Recommended errors for READ DISC INFORMATION Command

Error	Reference
Unit Attention conditions	Table F.1
CDB or parameter list validation errors	Table F.2
Readiness errors	Table F.3
General media access errors	Table F.5
Read errors	Table F.6
Hardware failures	Table F.8

6.23 READ DISC STRUCTURE Command

6.23.1 Introduction

The READ DISC STRUCTURE command requests that the Drive transfer data from areas on the media to the Host.

Table 381 shows the Features associated with the READ DISC STRUCTURE command.

Table 381 — Features Associated with the READ DISC STRUCTURE Command

Feature Number	Feature Name	Command Requirement
0004h	Write Protect	Format codes C0h Mandatory
001Fh	DVD Read	Format code 0,13,4 Mandatory
0024h	Defect Management (SSA = 1)	Format code 0Ah is Mandatory
002Ah	DVD+RW	Format code 0,1,3,4,5,30h Mandatory
002Bh	DVD+R	Format code 0,1,3,4,5,30h Mandatory
002Fh	DVD-R/-RW Write	Format code 4,5,0Fh Mandatory
0040h	BD Read	Format code 0,30h Mandatory
0050h	HD DVD Read	Format code 0,3,4,12h,15h Mandatory
0080h	Hybrid Disc	Format code 90h Mandatory
0106h	DVD CSS	Format code 02h is Mandatory
010Ah	DCB	Format code 30h is Mandatory
10Bh	DVD CPRM	Mandatory
010Dh	AACS	Mandatory

6.23.2 The CDB and Its Parameters

6.23.2.1 The CDB

The READ DISC STRUCTURE CDB is shown in Table 382.

Table 382 — READ DISC STRUCTURE CDB

Bit	7	6	5	4	3	2	1	0
Byte								
0	Operation Code (ADh)							
1	Reserved				Media Type			
2	(MSB) Address (LSB)							
3								
4								
5								
6								
7	Format							
8	(MSB) Allocation Length (LSB)							
9								
10	AGID			Reserved				
11	Control							

6.23.2.2 Media Type

Reported Disc Structures are often associated with a specific media type. Media Type codes are shown in Table 383.

Table 383 — Media Type Codes

Media Type Code	Media
0000b	DVD and HD DVD types
0001b	BD
0010b – 1111b	Reserved

6.23.2.3 Address

The Address field definition is dependent upon the value in the Format field.

6.23.2.4 Layer Number

Use of the Layer Number field is dependent upon the Media Type and Format fields.

6.23.2.5 Format

The Format field together with the Media Type field, specifies the disc structure that is requested by the Host. For Format field values C0h through FEh, the associated disc structure is the same for all Media Type codes. When the Drive/media combination does not support the specified Format code, the command shall be terminated with CHECK CONDITION status and SK/ASC/ASCQ shall be set to ILLEGAL REQUEST/INVALID FIELD IN CDB.

If a READ DISC STRUCTURE command is issued for media that is not consistent with this command and the format code is in the range 00h – BFh, the command shall be terminated with CHECK CONDITION status and SK/ASC/ASCQ shall be set to ILLEGAL REQUEST/CANNOT READ MEDIUM/INCOMPATIBLE FORMAT.

If there is no medium or an incompatible medium is installed, a request for Format FFh shall be fulfilled using a Drive specific media type.

6.23.2.6 Allocation Length

The Allocation Length field specifies the maximum number of bytes that may be returned by the Drive. An Allocation Length field of zero shall not be considered an error.

6.23.2.7 AGID

The AGID field is described in the REPORT KEY command. This field is used only when the Format field contains 2h, 6h or 7h with Address field of 00000000h, for all other values it is reserved.

6.23.3 Command Processing

6.23.3.1 Generic Disc Structures

For Format field values C0h through FEh, the associated disc structure has the same description for all Media Type codes. Defined Generic Format Codes are listed in Table 384.

Table 384 — Generic Format Code Definitions

Format Code	Layer Field Usage	Address Field Usage	Description
C0h	Reserved	Reserved	Write Protection Status
C1h – FEh	—	—	Reserved
FFh	—	—	READ/SEND DISC STRUCTURE capability list

6.23.3.1.1 Format Code C0h: Write Protection Status

The Write protection status is returned in the format as shown in Table 385.

Table 385 — READ DISC STRUCTURE Data Format (Format field = C0h)

Bit Byte	7	6	5	4	3	2	1	0
0	(MSB) DISC STRUCTURE Data Length (LSB)							
1								
2	Reserved							
3	Reserved							
Write Protection Status								
0	Reserved				MSWI	CWP	PWP	SWPP
1	Reserved							
2	Reserved							
3	Reserved							

The DISC STRUCTURE Data Length field specifies the length in bytes of the following DISC STRUCTURE data that is available to be transferred to the Host. The DISC STRUCTURE Data Length value does not include the DISC STRUCTURE Data Length field itself.

The Software Write Protection until Power down (SWPP) bit of one indicates that the software write protection is active. The SWPP bit of zero indicates that the software write protection is inactive. If the Drive does not support SWPP, this bit shall be set to zero.

The Persistent Write Protection (PWP) bit of one indicates that the media surface is set to write protected status. The PWP bit of zero indicates that the media surface is set to write permitted status. If the mounted medium and Drive do not support PWP, this bit shall be set to zero. If Write Inhibit is implemented via a WDCB, then any write inhibit action specified in the WDCB shall result in PWP set to one (see). If Write Inhibit is implemented via a Disc Write Protect (DWP) PAC, then any write inhibit action specified in the DWP PAC shall result in PWP set to one (see 4.11.7).

The Media Cartridge Write Protection (CWP) bit of one indicates that the write protect switch/tabs on a cartridge is set to write protected state. The CWP bit of zero indicates that the write protect switch/tabs on a cartridge is set to write permitted state. If the cartridge does not have CWP function or medium is mounted without cartridge, this bit shall be set to zero.

The Media Specific Write Inhibition (MSWI) bit of one indicates that any writing is inhibited by the media specific reason. The MSWI bit of zero indicates that writing is not inhibited by the media specific reason.

6.23.3.1.2 Format Code FFh: Disc Structure List

The Disc Structure List is returned in the format as shown in Table 386.

Table 386 — READ DISC STRUCTURE Data Format (Format field = FFh)

Bit Byte	7	6	5	4	3	2	1	0
0	(MSB) DISC STRUCTURE Data Length							
1	(LSB)							
2	Reserved							
3	Reserved							
Disc Structure List								
0 - n	Structure List							

The DISC STRUCTURE Data Length specifies the length in bytes of the following DISC STRUCTURE data that is available to be transferred to the Host. The DISC STRUCTURE Data Length value does not include the DISC STRUCTURE Data Length field itself.

Note 18. The returned data is a structure list of only those structures associated with the Media Type.

The Structure List is returned as a sequence of Structure List Entries as shown in Table 387.

This Disc Structure is generated by the Drive rather than read from the medium. Consequently, this structure shall be returned regardless of media presence.

Table 387 — Structure List Entry

Bit Byte	7	6	5	4	3	2	1	0
0	Format Code							
1	SDS	RDS	Reserved					
2	(MSB) Structure Length							
3	(LSB)							

The Format Code field shall identify a Disc Structure that is readable via the READ DISC STRUCTURE command.

The SDS bit, when set to zero, shall indicate that the Disc structure is not writable via the SEND DISC STRUCTURE command. When set to one, shall indicate that the Disc structure is writable via the SEND DISC STRUCTURE command.

The RDS bit, when set to zero, shall indicate that the Disc structure is not readable via the READ DISC STRUCTURE command. When set to one, shall indicate that the Disc structure is readable via the READ DISC STRUCTURE command.

The Structure Length field shall specify the length of the Disc Structure that is identified by the Format Code.

6.23.3.2 Disc Structures for Media Type = 0000b (DVD and HD DVD)

When Media Type = 0000b, Format field values 00h through BFh define disc structures that are specific to DVD and HD DVD discs. Defined Format Codes for Media Type = 0000b are listed in Table 388.

Table 388 — Structure Format Code Definitions for Media Type 0000b

Format Code	Layer Field Usage	Address Field Usage	Description
00h	Layer	Reserved	Physical Information from the DVD/HD DVD Lead-in area
01h	Layer	Reserved	Copyright Information from the DVD Lead-in area
02h	Reserved	Reserved	Disc Key obfuscated by a Bus Key
03h	Reserved	Reserved	Burst Cutting Area information on DVD/HD DVD media
04h	Layer	Reserved	Disc Manufacturing Information from the DVD/HD DVD Lead-in area
05h	Reserved	LBA	Copyright Management information from specified sector
06h	Reserved	Reserved	Media Identifier protected by a Bus Key
07h	Reserved	Pack Number	Media Key Block protected by a Bus Key
08h	Reserved	Reserved	DDS information on DVD-RAM Media
09h	Reserved	Reserved	DVD-RAM Medium Status
0Ah	Reserved	Reserved	DVD-RAM Spare Area Information
0Bh	Reserved	LBA	DVD-RAM Recording Type Information is returned from the specified
0Ch	Reserved	Reserved	DVD-R/-RW RMD in last border-out
0Dh	Reserved	Start Field Number of RMA blocks	Specified RMD field from last recorded border out on DVD-R/-RW
0Eh	Reserved	Reserved	Pre-recorded information from DVD-R/-RW lead-in
0Fh	Reserved	Reserved	DVD-R/-RW Media Identifier
10h	Layer	Reserved	DVD-R/-RW Physical Format Information
11h	Reserved	Reserved	ADIP Information
12h	Layer	Reserved	Copyright Protection Information from HD DVD Lead-in
13h-14h	Reserved		
15h	Layer	Start Copyright sector	Copyright Data Section from HD DVD Lead-in or DVD-ROM 3· adapted to AACs Lead-in
16h – 18h	Reserved		
19h	Reserved	Reserved	HD DVD-R Medium Status
1Ah	Reserved	Start Field Number of RMD Block	HD DVD-R - Last recorded RMD in the latest RMZ
1Bh – 1Fh	Reserved		

Table 388 — Structure Format Code Definitions for Media Type 0000b (continued)

Format Code	Layer Field Usage	Address Field Usage	Description
20h	Reserved	Reserved	DVD+/-R DL - Layer Capacity
21h	Reserved	Reserved	DVD-R DL - Middle Zone start address
22h	Reserved	Reserved	DVD-R DL – Jump Interval Size
23h	Reserved	Reserved	DVD-R DL - Start LBA of the manual layer jump
24h	Reserved	Anchor Point Number	DVD-R DL - Remapping information of the specified Ancor Point
25h – 2Fh	Reserved		
30h	Reserved/ Session number	Content Descriptor	Disc Control Block identified by content descriptor
31h	Reserved	PSN	Read MTA ECC Block from DVD+MRW disc
32h – 7Fh	Reserved		
80h	Reserved	Reserved	AACS volume identifier
81h	Reserved	Reserved	AACS media serial number
82h	Reserved	Reserved	AACS media identifier
83h	Layer Number	Pack Number	AACS media key block
84h – 8Fh	Reserved		
90h	Reserved	Reserved	List of recognized format layers
91h – BFh	Reserved		

6.23.3.2.1 Format Code 00h: Physical Format Information

For DVD-R/-RW media, this Format code returns the last updated Physical Format Information. Therefore, e.g., if a medium is recorded with multi-bordered area, this information is retrieved from the last Border-in. If the Control Data Zone information in the Lead-in is required for DVD-R/-RW media, use format code = 10h. For all other DVD class media, format code 00h returns information from the Control Data Zone in the lead-in.

This information is returned for DVD media only. The information for the layer specified by the Layer Number field in the Command Packet is returned. If there is only one layer then the only valid layer is layer 0. If a nonexistent layer is requested then the command shall be aborted with an INVALID FIELD IN CDB error. If the media has more than one layer, but is recorded using the Opposite Track Path method, then the same information shall be returned for all layers.

Physical Format Information is shown in Table 389.

Table 389 — READ DISC STRUCTURE Data Format (Format field = 00h)

Bit Byte	7	6	5	4	3	2	1	0
0	(MSB) DISC STRUCTURE Data Length							
1	(LSB)							
2	Reserved							
3	Reserved							
Physical Format Information								
0	Disk Category				Part Version			
1	Disc Size				Maximum Rate			
2	Reserved	Number of Layers		Track	Layer Type			
3	Linear Density				Track Density			
4	00h							
5	(MSB) Starting Physical Sector Number of Data Area							
6								
7	(LSB)							
8	00h							
9	(MSB) End Physical Sector Number of Data Area							
10								
11	(LSB)							
12	00h							
13	(MSB) End Physical Sector Number in Layer 0							
14								
15	(LSB)							
16	BCA	Reserved						
17 – 2047	Media Specific							

The DISC STRUCTURE Data Length specifies the length in bytes of the following DISC STRUCTURE data that is available to be transferred to the Host. The DISC STRUCTURE Data Length value does not include the DISC STRUCTURE Data Length field itself.

The Disk Category field (Table 390) specifies the DVD Book this media complies with.

Table 390 — Disk Category Field

Disk Category	Media
0000b	DVD-ROM
0001b	DVD-RAM
0010b	DVD-R
0011b	DVD-RW
1001b	DVD+RW
1010b	DVD+R
Others	Reserved

The Part Version specifies the media version according to its physical specification.

The Disc Size specifies the physical size of the Media. A value of 0000b specifies 120mm, a value of 0001b specifies a size of 80mm.

The Maximum Rate field (Table 391) is used to specify to the Drive the read rate to use for this media.

Table 391 — Maximum Rate Field

Maximum Rate	Read Rate
0000b	2.52 Mbps
0001b	5.04 Mbps
0010b	10.08 Mbps
1111b	Not Specified
Others	Reserved

The Number of Layers field specifies the number of layers for this side of the media. A value of 00b indicates that the media has only one layer. A value of 01b specifies that this side of the media has two layers. Currently only one and two layer discs are specified.

The Track Path bit specifies the direction of the layers when more than one layer is used. If the bit is set to 0 then this media uses Parallel Track Path (PTP). When PTP is used each layer is independent and has its own Lead-in and Lead-out areas on the media. If the bit is set to 1 then the media uses Opposite Track Path (OTP). With opposite track path both layers are tied together. There is only one Lead-in and Lead-out. In the middle of the media there is an area called the middle area. The addresses of blocks in one layer are mirrored in the other layer. The Layer Type field (Table 392) indicates the read/write ability of the layer.

Table 392 — Layer Type Field

Bit	Layer Type
0	Layer contains embossed data
1	Layer contains recordable area
2	Layer contains rewritable area
3	Reserved

The Linear Density field (Table 393) indicates the minimum/maximum pit length used for this layer.

Table 393 — Linear Density Field

Linear Density Code	Linear Density
0000b	0.267 um/bit
0001b	0.293 um/bit
0010b	0.409 to 0.435 um/bit
0100b	0.280 to 0.291 um/bit
1000b	0.353 um/bit
Others	Reserved

The Track Density field (Table 394) indicates the track width used for this media. Currently = 0000b 0.74 $\mu\text{m}/\text{track}$

Table 394 — Track Density Field

Track Density Code	Track Density
0000b	0.74 um/track
0001b	0.80 um/track
0010b	0.615 um/track
Others	Reserved

The Starting Sector Number of Data Area field (Table 395) specifies the first block that contains user data.

Table 395 — Starting Physical Sector Number of Data Area field

Starting Sector Number	Media Type
30000h	DVD-ROM, DVD-R/-RW, DVD+RW
31000h	DVD-RAM
Others	Reserved

The End Physical Sector Number of Data Area field specifies the last sector of the user data in the last layer of the media. For DVD-RAM, the End Physical Sector Number of Data Area is the PSN for the last spare sector of the last zone.

The End Sector Number in Layer 0 field specifies the last sector of the user data in layer 0. If this media does not use Opposite Track Path and contains Multiple Layers, this value is set to 000000h.

The Burst Cutting Area (BCA) flag indicates the presence of data in the Burst Cutting Area. If set to zero, it indicates BCA data does not exist. If set to one, it indicates BCA data exist.

In case of DVD-R/-RW, the Drive may have cache memory for the Lead-in Control data. If the disc has no Lead-in, and there is no DVD Control Data in the cache, the Drive shall generate CHECK CONDITION status and set SK/ASC/ASCQ values to ILLEGAL REQUEST/INVALID FIELD IN CDB. If the Lead-in is already written or there are DVD structures in the cache, the Drive shall return the requested structures.

The Media Specific field may be filled with all zero data or information as specified in the associated DVD specification.

Most of the data in the layer descriptor for DVD+RW media is from the ADIP information block. See [DVD+Ref2]. The DVD+RW layer descriptor is shown in Table 396.

Table 396 — DVD+RW Layer Descriptor

Bit Byte	7	6	5	4	3	2	1	0
0 – 8	Copy of bytes 0 through 8 from ADIP information block							
9	If CDZ PSN \leq 2F0FFh, then this value shall be the PSN of last recorded sector in DZ. Otherwise, this value may be either the PSN of last recorded sector in DZ, or the last possible PSN in the DZ.							
10								
11								
12 – 18	00h							
19 – 255	Copy of bytes 19 – 255 from ADIP information block							
256 – 2047	Reserved							

6.23.3.2.2 Format Code 01h: DVD Copyright Information

The Read DVD Structure data format 01h (Table 397) includes the DVD Copyright information response.

Table 397 — READ DISC STRUCTURE Data Format (Format field = 01h)

Bit Byte	7	6	5	4	3	2	1	0	
0	(MSB) DISC STRUCTURE Data Length								
1									(LSB)
2	Reserved								
3	Reserved								
DVD Copyright Information									
0	Copyright Protection System Type								
1	Region Management Information								
2	Reserved								
3	Reserved								

The DISC STRUCTURE Data Length specifies the length in bytes of the following DISC STRUCTURE data that is available to be transferred to the Host. The DISC STRUCTURE Data Length value does not include the DISC STRUCTURE Data Length field itself.

The Copyright Protection System Type field indicates the presence of data structures specific to a copyright protection system. Three values are defined, 00h indicates there is no such data and 01h indicates a specific data structure for CSS/CPPM exists, and 02h indicates a specific data structure for CPRM exists. All other values are reserved.

The Region Management Information field describes the regions in that the disc may be played. Each bit represents one of eight regions. If a bit is not set in this field, the disc may be played in the corresponding region. If a bit is set in this field the disc may not be played in the corresponding region.

6.23.3.2.3 Format Code 02h: Disc Key

The Disc Key data recorded on the media is identified with a data format defined in Table 398.

Table 398 — READ DISC STRUCTURE Data Format (Format field = 02h)

Bit Byte	7	6	5	4	3	2	1	0
0	(MSB) DISC STRUCTURE Data Length							(LSB)
1								
2	Reserved							
3	Reserved							
Disc Key Structures								
0	DISC KEY Data							
...								
2047								

The DISC STRUCTURE Data Length specifies the length in bytes of the following DISC STRUCTURE data that is available to be transferred to the Host. The DISC STRUCTURE Data Length value does not include the DISC STRUCTURE Data Length field itself.

DISC KEY Data field returns the DISC KEY data for CSS and/or the Album Identifier for CPPM that are obfuscated by a Bus Key. The length of DISC KEY Data field is currently 2 048 bytes.

When neither the DISC KEY data nor the Album Identifier exist on DVD media, this command with Format = 02h shall be terminated with CHECK CONDITION status and SK/ASC/ASCQ values shall be set to ILLEGAL REQUEST/COPY PROTECTION KEY EXCHANGE FAILURE – KEY NOT PRESENT.

When the DVD Drive is not in the Bus Key Established state for CSS/CPPM, this command with Format = 02h shall be terminated with CHECK CONDITION status and SK/ASC/ASCQ values shall be set to ILLEGAL REQUEST/COPY PROTECTION KEY EXCHANGE FAILURE – KEY NOT ESTABLISHED.

6.23.3.2.4 Format Code 03h: BCA Information

The BCA information is defined in data format 03h shown in Table 399.

Table 399 — READ DISC STRUCTURE Data Format (Format field =03h)

Bit	7	6	5	4	3	2	1	0	
Byte									
0	(MSB) DISC STRUCTURE Data Length								
1								(LSB)	
2	Reserved								
3	Reserved								
DVD BCA Structure									
0	BCA Information								
...									
n									

The DISC STRUCTURE Data Length specifies the length in bytes of the following DISC STRUCTURE data that is available to be transferred to the Host. The DISC STRUCTURE Data Length value does not include the DISC STRUCTURE Data Length field itself.

The BCA Information is returned from BCA recorded DVD media only. The Length of BCA Information is in the range of 12 to 188 bytes.

When a READ DISC STRUCTURE command with a Format field value of 03h is presented for a DVD media without BCA, the command shall be terminated with CHECK CONDITION status and SK/ASC/ASCQ values shall be set to ILLEGAL REQUEST/INVALID FIELD IN CDB.

6.23.3.2.5 Format Code 04h: DVD Disc Manufacturing Information

Table 400 defines the data format for the Disc Manufacturing information.

Table 400 — READ DISC STRUCTURE Data Format (Format field = 04h)

Bit	7	6	5	4	3	2	1	0
Byte								
0	(MSB) DISC STRUCTURE Data Length							
1	(LSB)							
2	Reserved							
3	Reserved							
DVD Manufacturing's Structures								
0	Disc Manufacturing Information							
...								
2047								

The DISC STRUCTURE Data Length specifies the length in bytes of the following DISC STRUCTURE data that is available to be transferred to the Host. The DISC STRUCTURE Data Length value does not include the DISC STRUCTURE Data Length field itself.

The Disc Manufacturing Information is taken from the DVD media Lead-in. In the case of DVD-R/-RW multi-session disc, this information is taken from the last Border-in.

6.23.3.2.6 Format Code 05h: Copyright Management Information

The Copyright Management Information returned is shown in Table 401.

Table 401 — READ DISC STRUCTURE Data Format (Format field = 05h)

Bit Byte	7	6	5	4	3	2	1	0
0	(MSB) DISC STRUCTURE Data Length							
1	(LSB)							
2	Reserved							
3	Reserved							
Copyright Management Information								
0	CPR_MAI							
1	Reserved							
2	Reserved							
3	Reserved							

The DISC STRUCTURE Data Length specifies the length in bytes of the following DISC STRUCTURE data that is available to be transferred to the Host. The DISC STRUCTURE Data Length value does not include the DISC STRUCTURE Data Length field itself.

The definition of the CPR_MAI field depends on the mounted media. The CPR_MAI field definition is shown in Table 402.

Table 402 — CPR_MAI Field Definition

Bit Media	7	6	5	4	3	2	1	0
DVD-ROM	CPM	CP_SEC	CGMS		CP_MOD			
DVD-R, ver 1.0 DVD-RW, ver 1.0	CPM	Resvd	CGMS		Reserved			
DVD-RAM Ver.1.0/2.1 DVD-R for Authoring Ver .2.0	Reserved							
DVD-R for General, ver 2.0, DVD- RW, ver 1.1, and DVD+RW	Reserved				ADP_TY		Reserved	

The CPM bit, if set to 0, indicates that this sector contains no copyrighted material. If the CPM bit is set to 1, this sector contains copyrighted material.

When the CPM bit is set to 0, the CP_SEC bit is set to zero. When the CPM bit is set to 1, the CP_SEC bit indicates whether this sector has a specific data structure for prerecorded media copyright protection system. A

value of 0 indicates that no such data structure exists in this sector. A value of 1 indicates a specific data structure for CSS or CPPM exists in this sector.

When the CPM bit is set to 0, the CGMS field is set to 00b. When the CPM bit is set to 1, and if the CGMS field is set to 00b, it indicates that copying is permitted without restriction. If the CGMS field is set to 01b, it indicates that the CGMS field is reserved, and if the CGMS field is set to 10b, indicates that one generation of copies may be made, and if the CGMS field is set to 11b, indicates that no copying is permitted.

When the CP_SEC bit is set to 0, the CP_MOD field is set to 0h. When the CP_SEC bit is set to 1, the CP_MOD field indicates the copyright protection mode of the specified sector. A value of 0h indicates the sector is scrambled by CSS. A value of 1h indicates the sector is encrypted by CPPM. Other values are reserved.

The ADP_TY field is defined only for DVD-RW Ver.1.1 and DVD-R for General Ver.2.0 media. The ADP_TY field, if set to 01b, indicates that this sector contains materials defined in DVD Specifications for Read-Only Disc Part 3 VIDEO SPECIFICATIONS. A value of 00b indicates that no such data exists in this sector. All other values of ADP_TY are reserved.

Note 19. For DVD-R/-RW media, a value of each field may not be correct at the first and last 16 sectors of each recording extent due to the nature of recording method for DVD-R/-RW media.

If the currently mounted medium is DVD+RW with basic formatting operating in background, or DVD+RW with MRW formatting operating in background, is command operation shall be as follows:

- a) If any of the sectors within the range specified by the CDB are in a blank area of the media where format writing has not yet occurred, the blank sectors shall not be read and the command shall fabricate and return data as if the sectors had been format written.
- b) If all of the sectors within the range specified by the CDB are in an area of the media where format writing has occurred, the command shall operate normally.

6.23.3.2.7 Format Code 06h: Media Identifier

The Media Identifier data recorded on the media is identified with a data format defined in Table 403.

Table 403 — READ DISC STRUCTURE Data Format (Format Field = 06h)

Bit	7	6	5	4	3	2	1	0	
Byte									
0	(MSB) DISC STRUCTURE Data Length								
1									(LSB)
2	Reserved								
3	Reserved								
Media Identifier Structures									
0	(MSB)								
:									
n									(LSB)

The DISC STRUCTURE Data Length specifies the length in bytes of the following DISC STRUCTURE data that is available to be transferred to the Host. The DISC STRUCTURE Data Length value does not include the DISC STRUCTURE Data Length field itself.

The Media Identifier Data field returns the Media Identifier that is protected by a Bus Key.

When the DVD Drive is not in the Bus Key Established state for CPRM, this command with Format = 06h shall be terminated with CHECK CONDITION status and SK/ASC/ASCQ values shall be set to ILLEGAL REQUEST/COPY PROTECTION KEY EXCHANGE FAILURE – KEY NOT ESTABLISHED.

6.23.3.2.8 Format Code 07h: Media Key Block

The Media Key Block pack data recorded on the media is identified with a data format defined in Table 404.

Table 404 — READ DISC STRUCTURE Data Format (Format Field = 07h)

Bit	7	6	5	4	3	2	1	0
Byte								
0	(MSB) DISC STRUCTURE Data Length							
1	(LSB)							
2	Reserved							
3	Total Packs							
Media Key Block Structures								
0	(MSB)							
:	Media Key Block Pack Data							
n	(LSB)							

The DISC STRUCTURE Data Length specifies the length in bytes of the following DISC STRUCTURE data that is available to be transferred to the Host. The DISC STRUCTURE Data Length value does not include the DISC STRUCTURE Data Length field itself.

The Total Packs field reports the total number of Media Key Block Packs that are available for transfer to the Host.

The Media Key Block Pack Data field returns the requested Media Key Block Pack that is protected by a Bus Key only when the Address field set to 00000000h.

The Address field in the command specifies the available Media Key Block Packs that shall be read. A valid AGID field value shall be supplied only when the Address field is set to 00000000h.

If the Address field value is 00000000h, the DVD Drive is not in the Bus Key Established state for CPRM, and Format = 07h, this command shall be terminated with CHECK CONDITION status and SK/ASC/ASCQ values shall be set to ILLEGAL REQUEST/COPY PROTECTION KEY EXCHANGE FAILURE – KEY NOT ESTABLISHED.

6.23.3.2.9 Format Code 08h: DVD-RAM Disc Definition Structure (DDS)

The DVD-RAM Disc definition is identified with the data format defined in Table 405.

Table 405 — READ DISC STRUCTURE Data Format (Format field = 08h)

Bit	7	6	5	4	3	2	1	0
Byte								
0	(MSB) DISC STRUCTURE Data Length							
1								(LSB)
2	Reserved							
3	Reserved							
DVD-RAM Disc Definition Structure (DDS)								
0	DDS Information							
...								
2047								

The DISC STRUCTURE Data Length specifies the length in bytes of the following DISC STRUCTURE data that is available to be transferred to the Host. The DISC STRUCTURE Data Length value does not include the DISC STRUCTURE Data Length field itself.

The DDS Information is taken from the Defect Controls of the DVD-RAM media lead-in. The length of the DDS Information is currently 2 048 bytes only.

When a READ DISC STRUCTURE command with a format field value of 08h is presented for other than DVD-RAM media, the command shall be terminated with CHECK CONDITION status and SK/ASC/ASCQ values shall be set to ILLEGAL REQUEST/INVALID FIELD IN CDB.

6.23.3.2.10 Format Code 09h: DVD-RAM Medium Status

The DVD-RAM Medium Status data returned is defined in Table 406.

Table 406 — READ DISC STRUCTURE Data Format (Format = 09h)

Bit	7	6	5	4	3	2	1	0
Byte								
0	(MSB) DISC STRUCTURE Data Length							
1	(LSB)							
2	Reserved							
3	Reserved							
DVD-RAM Medium Status Data								
0	Cartridge	OUT	Reserved		MSWI	CWP	PWP	Reserved
1	Disc Type Identification							
2	Reserved							
3	RAM – SWI Information							

When a READ DISC STRUCTURE command with the Format field value of 09h is issued for other than DVD-RAM media, this command shall be terminated with CHECK CONDITION status and SK/ASC/ASCQ values shall be set to ILLEGAL REQUEST/INVALID FIELD IN CDB.

The DISC STRUCTURE Data Length indicates the length in bytes of the following DVD Structure data that is available to be transferred to the Host. The DVD Structure Data Length value does not include the DISC STRUCTURE Data Length field itself.

The Cartridge bit of one indicates that a medium is in a cartridge. The Cartridge bit of zero indicates that a medium is not in a cartridge.

The Out bit of one indicates that a medium has been taken out from a cartridge or a medium is put into a cartridge. The Out bit of zero indicates that a medium has not been taken out from a cartridge. This field is valid only when the Cartridge bit is set to one. If the Cartridge bit is set to zero, the Out bit shall be set to zero.

The Media Specific Write Inhibition (MSWI) bit of one indicates that the writing is inhibited by the specific reason. The reason is indicated in the RAM-SWI Information field. The MSWI bit of zero indicates that the writing is not inhibited by the specific reason.

The Persistent Write Protection (PWP) bit of one indicates that the media surface is set to write protected status. The PWP bit of zero indicates that the media surface is set to write permitted status.

The Media Cartridge Write Protection (CWP) bit of one indicates that the write protect switch/tabs on a cartridge is set to write protected state. The CWP bit of zero indicates that the write protect switch/tabs on a cartridge is set to write permitted state. This field is valid only when the Cartridge bit is set to one. If the Cartridge bit is set to zero, the CWP bit shall be set to zero.

The Disc Type Identification field indicates the Disc Type:

00h: A Disc shall not be written without a cartridge.

10h: A Disc may be written without a cartridge.

Others: Reserved

The DVD-RAM Specific Write Inhibition Information (RAM-SWI Information) field indicates the reason of DVD-RAM specific write inhibition status. This field is valid only when the MSWI bit is set to one.

If MSWI bit is set to one, RAM-SWI Information field shall be set according to Table 407.

Table 407 — RAM-SWI Information field definition

Value	Description
00h	Reserved
01h	Bare Disc Write Inhibition (Disc Type Identification field of 00h and no cartridge)
02h-Feh	Reserved
FFh	Unspecified reason

6.23.3.2.11 Format Code 0Ah: DVD-RAM Spare Area Information

The DVD-RAM Spare Area Information data returned is defined in Table 408.

Table 408 — READ DISC STRUCTURE Data Format (Format = 0Ah)

Bit Byte	7	6	5	4	3	2	1	0
0	(MSB) DISC STRUCTURE Data Length							
1	(LSB)							
2	Reserved							
3	Reserved							
DVD-RAM Spare Area Information								
0	(MSB)							
1	Number of unused Primary Spare blocks							
2								
3	(LSB)							
4	(MSB)							
5	Number of unused Supplementary Spare blocks							
6								
7	(LSB)							
8	(MSB)							
9	Number of allocated Supplementary Spare blocks							
10								
11	(LSB)							

When a READ DISC STRUCTURE command with the Format field value of 0Ah is issued for other than DVD media that is capable of allocation of the Supplementary Spare area, this command shall be terminated with CHECK CONDITION status and SK/ASC/ASCQ values shall be set to ILLEGAL REQUEST/INVALID FIELD IN CDB.

The Host may recognize whether the media is capable of allocation of the Supplementary Spare area or not, indicated in the Defect Management Feature Descriptor reported by the GET CONFIGURATION command.

The DISC STRUCTURE Data Length indicates the length in bytes of the following DVD Structure data that is available to be transferred to the Host. The DVD Structure Data Length value does not include the DISC STRUCTURE Data Length field itself.

The Number of unused Primary Spare blocks field indicates the number of unused spare blocks in the Primary Spare area.

The number of unused Supplementary Spare blocks field indicates the number of unused spare blocks in the Supplementary Spare area.

The number of allocated Supplementary Spare blocks field indicates the number of allocated spare blocks in the Supplementary Spare area.

6.23.3.2.12 Format Code 0Bh: DVD-RAM Recording Type Information

If a READ DISC STRUCTURE command with the Format code value of 0Bh is issued for other than DVD-RAM Ver.2.1 media, the command shall be terminated with CHECK CONDITION status and sense bytes SK/ASC/ASCQ shall be set to ILLEGAL REQUEST/INVALID FIELD IN CDB.

Table 409 — READ DISC STRUCTURE Data Format (Format = 0Bh)

Bit Byte	7	6	5	4	3	2	1	0
0	(MSB) DISC STRUCTURE Data Length							
1	(LSB)							
2	Reserved							
3	Reserved							
DVD-RAM Recording Type Information								
0	Reserved			Recording Type	Reserved			
1	Reserved							
2	Reserved							
3	Reserved							

The DISC STRUCTURE Data Length field specifies the length in bytes of the following DVD Structure data that is available to be transferred to the Host. The DISC STRUCTURE Data Length value does not include the DISC STRUCTURE Data Length field itself.

The Recording Type bit is defined only for DVD-RAM Ver.2.1 media. The Recording Type bit, if set to 1b, indicates that this sector contains a real-time data. A value of 0b indicates that this sector contains a general data. The Streaming bit of the WRITE (12) command shall be used to set/clear the Recording Type bit.

6.23.3.2.13 Format Code 0Ch: RMD in the last Border-out

The RMD field recorded in the Border-out is defined in Table 410.

Table 410 — READ DISC STRUCTURE Data Format (Format field = 0Ch)

Bit	7	6	5	4	3	2	1	0
Byte								
0	(MSB) DISC STRUCTURE Data Length							
1								(LSB)
2	Reserved							
3	Reserved							
RMD in last Border-out								
0	RMD							
...								
n								

The DISC STRUCTURE Data Length specifies the length in bytes of the following DISC STRUCTURE data that is available to be transferred to the Host. The DISC STRUCTURE Data Length value does not include the DISC STRUCTURE Data Length field itself.

The RMD Bytes field returns the RMD that is written in the last recorded Border-out.

The Address field in the command specifies the starting RMD Field number where the read operation shall begin. The Allocation Length field in the command specifies the maximum number of RMD bytes that shall be returned. The largest RMD available is 30 720 bytes (15 sectors).

6.23.3.2.14 Format Code 0Dh: Recording Management Area Data

The DVD-R/-RW Recording Management Data Structure sectors recorded in the RMA, on the media, is identified with the data format defined in Table 411. This format is available only for DVD-R/-RW media. For other media, this format is reserved.

Table 411 — READ DISC STRUCTURE Data Format (Format field = 0Dh)

Bit Byte	7	6	5	4	3	2	1	0	
	DISC STRUCTURE Data Length								
								(LSB)	
2	Reserved								
3	Reserved								
DVD-R/-RW Recording Management Data Structure									
0	Last Recorded RMA Sector Number/Start Sector Number of Valid Format 3 RMD Set								(LSB)
1									
2									
3									
4	RMD Bytes								
...									
n									

The DISC STRUCTURE Data Length specifies the length in bytes of the following DISC STRUCTURE data that is available to be transferred to the Host. The DISC STRUCTURE Data Length value does not include the DISC STRUCTURE Data Length field itself.

Last Recorded RMA Sector Number / Start Sector Number of Valid Format 3 RMD Set field indicates the RMA sector number where the last RMD is recorded. On DVD-RW restricted overwritten media, this field indicates the start sector number of valid Format 3 RMD Set.

The RMD Bytes field returns RMD that is written in RMA. The Address field in the command specifies the starting address of the RMA sector where the read operation shall begin. The Allocation Length field in the command specifies the maximum length of the descriptor returned to the Host. The returned RMD data shall end at the next ECC boundary.

The maximum number of RMD bytes that may be returned is 32 768.

6.23.3.2.15 Format Code 0Eh: Pre-recorded Information in Lead-in

The Pre-recorded Information in Lead-in area recorded on the media is identified with a data format defined in Table 412. This format is available only for DVD-R/-RW media. For other media, this format is reserved.

Table 412 — READ DISC STRUCTURE Data Format (Format field = 0Eh)

Bit Byte	7	6	5	4	3	2	1	0
0	(MSB) DISC STRUCTURE Data Length							
1	(LSB)							
2	Reserved							
3	Reserved							
DVD-R Pre-recorded Information Structure								
0	Field ID (= 1)							
1	Disc Application code							
2	Disc Physical code							
3	(MSB)							
4	Last address of Data Recordable Area							
5	(LSB)							
6	Reserved (DVD-R/-RW Ver.1.0)							
	Part Version (R for General Ver.2.0/R for Authoring Ver.2.0)				Extension code (R for General Ver.2.0/R for Authoring Ver.2.0)			
7	Reserved							
8	Field ID (= 2)							
9	OPC Suggested Code							
10	Wavelength Code (all R media) / OPC suggested code (RW Ver.1.0)							
11 – 14	Write Strategy Code							
15	Reserved							
16	Field ID (= 3)							
17 – 22	Manufacturer ID							
23	Reserved							
24	Field ID (= 4)							
25 – 30	Manufacturer ID							
31	Reserved							
32	Field ID (= 5)							
33 – 38	Manufacturer ID (R Ver.1.0) / Write Strategy code (RW Ver.1.0 /R for General Ver.2.0/R for Authoring Ver.2.0)							
39	Reserved							
40 – 63	Reserved							

The DISC STRUCTURE Data Length specifies the length in bytes of the following DISC STRUCTURE data that is available to be transferred to the Host. The DISC STRUCTURE Data Length value does not include the DISC STRUCTURE Data Length field itself.

The contents of Pre-recorded information are specified by the DVD Specifications for Recordable Disc, Part 1 or DVD Specifications for Re-recordable Disc Part 1.

6.23.3.2.16 Format Code 0Fh: Unique Disc Identifier

The Unique Disc Identifier data recorded on the media is identified with a data format defined in Table 413. This format is available only for DVD-R/-RW media. For other media, this format is invalid and reserved.

Table 413 — READ DISC STRUCTURE Data Format (Format field = 0Fh)

Bit Byte	7	6	5	4	3	2	1	0
0	(MSB) DISC STRUCTURE Data Length (LSB)							
1								
2	Reserved							
3	Reserved							
DVD-R/-RW Unique Disc Identifier								
0	Reserved							
1	Reserved							
2	(MSB) Random Number (LSB)							
3								
4	(MSB) Year (LSB)							
5								
6								
7								
8	(MSB) Month (LSB)							
9								
10	(MSB) Day (LSB)							
11								
12	(MSB) Hour (LSB)							
13								
14	(MSB) Minute (LSB)							
15								
16	(MSB) Second (LSB)							
17								

The DISC STRUCTURE Data Length specifies the length in bytes of the following DISC STRUCTURE data that is available to be transferred to the Host. The DISC STRUCTURE Data Length value does not include the DISC STRUCTURE Data Length field itself.

This format returns the Unique Disc Identifier that is recorded in RMD Field 0.

6.23.3.2.17 Format Code 10h: Format Information of Control Data Zone in the Lead-in

This format is available only for DVD-R/-RW media. For other media, this format is invalid and reserved.

This Format code returns Physical Format Information of Control Data Zone in the Lead-in area even if the disc is recorded with multi-bordered area.

Table 414 — READ DISC STRUCTURE Data Format (With Format field = 10h)

Bit Byte	7	6	5	4	3	2	1	0
0	Disk Category				Part Version			
1	Disc Size				Maximum Rate			
2	Reserved	Number of Layers		Track Path	Layer Type			
3	Linear Density				Track Density			
4	00h							
5	(MSB) Starting Physical Sector Number of Data Area (LSB)							
6								
7								
8	00h							
9	(MSB) End Physical Sector Number of Data Area (LSB)							
10								
11								
12	00h							
13	(MSB) End Physical Sector Number in Layer 0 (LSB)							
14								
15								
16	BCA				Reserved			
17 – 2047	Media Specific							

The Media Specific field shall return information as specified in the associated DVD specification.

The other field definitions are same as the definitions of Format code 00h.

6.23.3.2.18 Format Code 11h: ADIP Information

The information in this structure is formatted as in Format Code = 0, but uses unmodified ADIP information from the DVD+R/+RW disc. The format of the ADIP Information is shown in Table 415.

Table 415 — READ DISC STRUCTURE Data Format (With Format field = 11h)

Bit Byte	7	6	5	4	3	2	1	0	
0	(MSB) DISC STRUCTURE Data Length								
1									(LSB)
2	Reserved								
3	Reserved								
ADIP Information									
0	ADIP Information Block (see [DVD+Ref2])								
1									
...									
255									

6.23.3.2.19 Format Code12h: Copyright Protection Information from HD DVD Lead-in

This format provides the Host with HD DVD Copyright Protection Information from the System Lead-in of the HD DVD disc.

Table 416 — READ DISC STRUCTURE Data Format (With Format field = 12h)

Bit	7	6	5	4	3	2	1	0	
Byte									
0	(MSB) DISC STRUCTURE Data Length								
1								(LSB)	
2	Reserved								
3	Reserved								
HD DVD Copyright Protection Information									
0	HD DVD Copyright Protection Information Data								
1									
...									
2 047									

The DISC STRUCTURE Data Length field indicates the length in bytes of the following DISC STRUCTURE data that is available to be transferred to the host. The DISC STRUCTURE Data Length value does not include the DISC STRUCTURE Data Length field itself.

The length of the HD DVD Copyright Protection Information Data field is 2048 bytes.

6.23.3.2.20 Format Code 15h: Copyright Data Section from HD DVD/DVD-ROM3 - AACS adjusted

This format provides information from the Copyright data section in the Control data zone.

Table 417 — READ DISC STRUCTURE Data Format (With Format field = 15h)

Bit	7	6	5	4	3	2	1	0	
Byte									
0	(MSB) DISC STRUCTURE Data Length								
1									(LSB)
2	Reserved								
3	Reserved								
Copyright Data Section									
0	Copyright Data								
1									
...									
N-1									

The DISC STRUCTURE Data Length field indicates the length in bytes of the following DISC STRUCTURE data that is available to be transferred to the host. The DISC STRUCTURE Data Length value does not include the DISC STRUCTURE Data Length field itself.

For HD DVD, the Address field in the CDB specifies the starting address of the Copyright data section sector position from 0 to 31 where the read operation shall begin. The Allocation Length field in the CDB specifies the maximum length of the descriptor returned to the host. The maximum number of Copyright data returned is 63 488 that contains 31 sectors.

For DVD adapted to AACS, the Address field in the CDB specifies the starting address of the Copyright data section sector position from 2 to 15 where the read operation shall begin. The Allocation Length field in the CDB specifies the Format Code 19h: HD DVD-R Medium Status maximum length of the descriptor returned to the Host. The maximum number of bytes of the Copyright data section returned is 28 672.

6.23.3.2.21 Format Code 19h: HD DVD-R Medium Status

Format code 19h returns HD DVD-R medium status that reflects the extension status of the disc.

Table 418 — READ DISC STRUCTURE Data Format (With Format field = 19h)

Bit	7	6	5	4	3	2	1	0	
Byte									
0	(MSB) DISC STRUCTURE Data Length								
1									(LSB)
2	Reserved								
3	Reserved								
HD DVD-R Medium Status									
0	Reserved								Extended Test Zone
1	Number of remaining RMDs in RDZ								
2	(MSB) Number of remaining RMDs in Current RMZ								
3									(LSB)

The DISC STRUCTURE Data Length field indicates the length in bytes of the following DISC STRUCTURE data that is available to be transferred to the host. The DISC STRUCTURE Data Length value does not include the DISC STRUCTURE Data Length field itself.

The Extended Test zone bit of one indicates that Test zone has been extended.

The Number of remaining RMDs in RDZ field indicates the number of the unrecorded ECC blocks in the RDZ.

The Number of remaining RMDs in Current RMZ field indicates the number of the unrecorded ECC blocks in the current RMZ.

6.23.3.2.22 Format Code 1Ah: HD DVD-R - Last recorded RMD in the latest RMZ

Format code 1Ah returns the last recorded RMD which is written in the latest RMZ.

Table 419 — READ DISC STRUCTURE Data Format (With Format field = 1Ah)

Bit	7	6	5	4	3	2	1	0	
Byte									
0	(MSB) DISC STRUCTURE Data Length								
1								(LSB)	
2	Reserved								
3	Reserved								
Last recorded RMD in the latest RMZ									
0	RMD data								
1									
...									
N									

The DISC STRUCTURE Data Length field indicates the length in bytes of the following DISC STRUCTURE data that is available to be transferred to the host. The DISC STRUCTURE Data Length value does not include the DISC STRUCTURE Data Length field itself.

For HD DVD, the RMD Bytes field returns the last recorded RMD which is written in the latest RMZ.

The Address field in the CDB specifies the starting RMD Field number where the read operation shall begin.

The Allocation Length field in the CDB specifies the maximum number of RMD bytes that shall be returned. The largest RMD available is 45 056 (22 sectors).

6.23.3.2.23 Format Code 20h: DVD+/-R DL - Layer Capacity

This format is available for DVD-R Dual Layer / DVD+R Double Layer disc. For other media, this format is invalid and reserved.

This Format code returns the Layer boundary information. In the case of DVD -R Dual Layer disc, this value is fixed (=Start address of Fixed Middle Area) and is not changeable.

Table 420 — READ DISC STRUCTURE Data Format (With Format field = 20h)

Bit Byte	7	6	5	4	3	2	1	0
0	(MSB) DISC STRUCTURE Data Length							(LSB)
1								
2	Reserved							
3	Reserved							
Layer Boundary Information								
0	Init Status	Reserved						
1	Reserved							
2	Reserved							
3	Reserved							
4	(MSB) L0 Data Area Capacity							(LSB)
5								
6								
7								

Init Status bit indicates whether the capacity of Data Area is changeable by the host or not. When Init Status is set to zero, L0 Data Area Capacity value has not been written into the Control Data Zone and the capacity of the medium shall be the default capacity. The host may specify a smaller capacity value by using the SEND DISC STRUCTURE command with Format Code = 20h. When Init Status is set to one, L0 Data Area Capacity value has been specified and may not be changed.

L0 Data Area Capacity is the number of Data Area sectors available for recording on L0. This value shall be an integral multiple of 16. The capacity of L0 is the number of sectors between the end of the Lead-in and the first sector of the Middle Area.

In the case of DVD+R Double Layer disc when no L0 Data Area Capacity has been selected, the default capacity shall be based upon the Lead-in ADIP. The disc provides exactly the same capacity in ECC blocks on each Layer. If the DVD+R Double Layer disc is completely blank, Init Status shall be set to zero and the default L0 Data Area Capacity shall be reported.

In the case of DVD-R Dual Layer disc, Init Status bit shall be set to 1 regardless of disc status. L0 Data Area Capacity is calculated from the Fixed Middle Area start address.

6.23.3.2.24 Format Code 21h: DVD-R DL - Middle Zone start address

This format is available for DVD-R Dual Layer discs. For other media, this format is invalid and reserved.

This Format code returns the start logical block address of Shifted Middle Area on L0.

Table 421 — READ DISC STRUCTURE Data Format (With Format field = 21h)

Bit Byte	7	6	5	4	3	2	1	0
0	(MSB) DISC STRUCTURE Data Length = 000Ah							
1	(LSB)							
2	Reserved							
3	Reserved							
Shifted Middle Area Information								
0	Init Status	Reserved						
1	Reserved							
2	Reserved							
3	Reserved							
4	(MSB)							
5	Shifted Middle Area Start Address							
6								
7	(LSB)							

The Init Status bit indicates whether the Shifted Middle Area start address is changeable by the host or not. When Init Status is set to zero, Shifted Middle Area start address is changeable. If this bit is set to 1, Shifted Middle Area start address is not changeable. The address of Shifted Middle Area has been registered in RMD on the disc.

The Shifted Middle Area Start Address is the start logical block address of the Shifted Middle Area on L0. If this value is set to 0, the Shifted Middle Area is not specified on the medium.

6.23.3.2.25 Format Code 22h: DVD-R DL – Jump Interval Size

This format is available for DVD-R Dual Layer discs. For other media, this format is invalid and reserved.

This Format Code returns the Jump Interval size for the Regular Interval Layer Jump recording by number of blocks. The Jump Interval size is specified by the SEND DISC STRUCTURE command with Format Code =22h.

Table 422 — READ DISC STRUCTURE Data Format (With Format field = 22h)

Bit Byte	7	6	5	4	3	2	1	0
0	(MSB) DISC STRUCTURE Data Length = 000Ah							
1	(LSB)							
2	Reserved							
3	Reserved							
Jump Interval Size								
0 - 3	Reserved							
4	(MSB)							
5	Jump Interval Size							
6								
7	(LSB)							

The Jump Interval size field indicates the Jump Interval size for the Regular Interval Layer Jump recording. If the Jump Interval size is not specified to the Invisible/Incomplete RZone, the Jump Interval size field shall be set to 0.

6.23.3.2.26 Format Code 23h: DVD-R DL - Manual Layer Jump Address

This format is available for DVD-R Dual Layer discs. For other media, this format is invalid and reserved.

This Format code returns the Manual Layer Jump Address specified by Manual Layer Jump Address (Format Code = 23h) of SEND DISC STRUCTURE command on L0.

Table 423 — READ DISC STRUCTURE Data Format (With Format field = 23h)

Bit	7	6	5	4	3	2	1	0	
Byte									
0	(MSB) DISC STRUCTURE Data Length = 000Ah								
1								(LSB)	
2	Reserved								
3	Reserved								
Manual Layer Jump Address Information									
0 - 3	Reserved								
4	(MSB)								
5	Manual Layer Jump Address								
6									
7									(LSB)

The Layer Jump Logical Block Address field indicates the Manual Layer Jump Address. After the specified Manual Layer Jump has happened or if no Layer jump is specified, Jump Interval size field shall be set to 0.

6.23.3.2.27 Format Code 24h: DVD-R DL - Remapping information of the specified Anchor Point

This format is available for DVD-R Dual Layer discs. For other media, this format is invalid and reserved.

This Format code returns the remapping address information of the specified Anchor Point.

Table 424 — READ DISC STRUCTURE Data Format (With Format field = 24h)

Bit Byte	7	6	5	4	3	2	1	0
0	(MSB) DISC STRUCTURE Data Length = 000Ah (LSB)							
1								
2	Reserved							
3	Reserved							
Remapping Information								
0 - 3	Reserved							
4	(MSB) Remapping Address (LSB)							
5								
6								
7								

The Remapping Address field indicates the first logical block address of the ECC block that is used to reassign the Anchor Point block specified by Address field of CDB. If this value is set to 0, there is no valid remapped data of Anchor Point block.

The Address field of CDB is used to specify the Anchor Point Number. Single remapping information shall be reported.

6.23.3.2.28 Format Code 30h: Disc Control Blocks

6.23.3.2.28.1 Overview

A Disc Control Block is a structure on DVD+R/+RW media that specifies format or use information. Each Disc Control Block is up to 16 sectors in length. The DCB header is the first 40 bytes of the block. The DCB Header fields have a common definition, while the remaining bytes depend on the value of the Content Descriptor field (see Table 425). The Disc Control Blocks are defined in the [DVD+Ref1], [DVD+Ref2], [DVD+Ref3], and [DVD+Ref4].

If a Disc Control Block, with fewer than 32 768 bytes is read, the Drive shall pad the Disc Control Block with 00h bytes.

Table 425 — Generic Disc Control Block

Bit	7	6	5	4	3	2	1	0
Byte								
0	(MSB) Content Descriptor (LSB)							
...								
3								
4	(MSB) Unknown Content Descriptor Actions (LSB)							
...								
7								
8 - 39	Vendor ID							
40 - 32 767	DCB Data							

The location of a DCB is dependent upon its content descriptor.

The Address field of the READ DISC STRUCTURE command shall contain a Content Descriptor to identify the Disc Control Blocks (DCB) requested. The Content Descriptor field identifies the contents of bytes 40 – 32 767. Valid values are shown in Table 426.

Table 426 — Valid Values for Content Descriptor

Content Descriptor	Definition
00000000h	Reserved
00000001h – FFFFFFFDh	The DCB with a matching Content Descriptor is returned
FFFFFFFEh	Reserved
FFFFFFFh	Return a list of readable and writable DCB Content Descriptors

The Unknown Content Descriptor Actions field contains a bit mask. This mask shall describe actions the Drive is allowed to perform if the Drive does not know the Content Descriptor. Each bit, when set to one, shall prohibit the corresponding action. When set to zero, the corresponding action is allowed.

Table 427 — Unknown Content Descriptor Actions

Bit	Actions
0	Recording within the user data area
1	Reading DCBs
2	Formatting of the medium
3	Modification of this DCB
4–31	Reserved

The Vendor ID field contains 24 arbitrary bytes.

6.23.3.2.28.2 Formatting DCB (FDCB)

The FDCB (Content Descriptor = 46444300h) is a 32 768-byte read-only structure that aids the Drive during background formatting. Refer to [DVD+Ref2] for specific content descriptions.

6.23.3.2.28.3 Write Inhibit DCB (WDCB)

The WDCB (Content Descriptor = 57444300h) is a 32 768 byte structure as shown in Table 428.

Table 428 — WDCB Format

Bit	7	6	5	4	3	2	1	0
Byte								
0 – 39	DCB Header							
40 – 43	WDCB Update Count							
44 – 47	Write Protect Actions							
48 – 63	Reserved							
64 – 95	WDCB Password							
96 – 32 767	Reserved							

The DCB header format is shown in Table 425:

The WDCB Update Count is set to zero when the WDCB is created and incremented each time the WDCB is updated.

Write Protect Actions (Table 429) is a 32-bit field that defines the write protect actions assigned to the DCB.

Table 429 — Write Protect Actions Field

Bit	Meaning
31	Reserved (0)
...	...
8	Reserved (0)
7	When zero (0), the WDCB is not password protected. When one (1), the WDCB is password protected.
6	Reserved (0)
...	...
2	Reserved (0)
1	Write Protect Status: 00b = Media is fully write enabled 01b = Writing in the data zone is not permitted
0	10b = Writing to a LBA space as defined by a hardware defect management system (e.g. MRW) is not permitted 11b = No writing (except WDCB changes) is permitted

The WDCB Password, when enabled, permits WDCB changes only when the correct password is supplied by the Host during a SEND DISC STRUCTURE command with format code = 30h (6.33.3.2.9). In the case of the READ DISC STRUCTURE command with format code = 30h, the WDCB password shall always be zero filled before WDCB information is transferred to the Host.

Refer to [DVD+Ref2] for specific field definitions.

6.23.3.2.28.4 Session DCB

If Session Number does not exist, the drive shall terminate the command with CHECK CONDITION status and set sense bytes SK/ASC/ASCQ to ILLEGAL REQUEST/INVALID PARAMETER IN CDB. The Session DCB (Content Descriptor = 53444300h) has two forms: Session descriptor and fragment descriptor. The Session form defines Session boundary information, while the Fragment form defines Fragment boundary and content information. The general structure of a SDCB is shown in Table 430.

Table 430 — SDCB Format

Byte	Bit	7	6	5	4	3	2	1	0
0 – 39		DCB Header							
40 – 41		Session Number							
42 – 63		Reserved							
64 – 95		Disc ID (in Lead-in SDCBs)							
96 – 127		Reserved							
128 – 8 191		Session Items							
8 192 – 32 767		3 Repetitions of bytes 0 through 8 191							

The DCB header format is shown in Table 425.

The Session Number identifies the session to which this SDCB belongs.

The Disc ID field contains a random 256-bit disc ID that is generated upon opening the first session.

The Session Items is a set of 16-byte session information records. The session information may contain session boundary and content data or fragment boundary and content information. Unused session items shall be zero filled. Used session items shall appear at the beginning of the list.

Detailed format information is found in [DVD+Ref1].

Note 20. The SDCB is read-only.

6.23.3.2.28.5 DCB List

When Content Descriptor FFFFFFFFh (Table 431) is requested, the Drive shall generate a list of DCBs that may be read from and/or recorded on the current medium by the Host. If the Drive records DCBs that are generated internally, and those DCBs may not be sent from the Host, the Drive shall not report those DCBs as recordable.

Table 431 — Disc Control Block (FFFFFFFh)

Bit	7	6	5	4	3	2	1	0
Byte								
0	(MSB) Content Descriptor = FFFFFFFFh (LSB)							
...								
3								
4 – 7	Reserved							
8 – 39	Vendor ID							
40	Reserved							
41	Number of Readable DCBs (= M)							
42	Reserved							
43	Number of Recordable DCBs (= N)							
44	(MSB) Readable DCB 0 (LSB)							
...								
47								
	...							
M * 4 + 40	(MSB) Readable DCB M-1 (LSB)							
...								
M * 4 + 43								

Table 431 — Disc Control Block (FFFFFFFh) cont.

Bit	7	6	5	4	3	2	1	0
Byte								
M * 4 + 44	(MSB) Recordable DCB 0 (LSB)							
...								
M * 4 + 47								
	...							
(M + N) * 4 + 40	(MSB) Recordable DCB N – 1 (LSB)							
...								
(M + N) * 4 + 43								

The Content Descriptor field shall contain FFFFFFFFh.

The Unknown Content Descriptor Actions field shall be set to zero.

The Vendor ID field shall be set to the value the Drive uses for its own DCBs.

The Number of Readable DCBs field shall identify the number of entries in the Readable DCB list.

The Number of Recordable DCBs field shall identify the number of entries in the Recordable DCB list.

Each Readable DCB field shall contain a Content Descriptor of a DCB that may be read from the medium.

Each Recordable DCB field shall contain a Content Descriptor of a DCB that may be sent from the Host. If a DCB is both readable and recordable, the DCB shall appear in both lists. The Drive shall not record any DCB that it does not recognize.

6.23.3.2.29 Format Code 31h: Read MTA ECC Block

Format Code 31h permits for reading ECC blocks in the MTA. Support for Format Code 31h is optional since its only purpose is to aid in data recovery on media corrupted by an unexpected RESET or power-off.

If a Drive supports Format Code 31h, it shall return data from ECC blocks within the MTA addressed by PSN. A specific ECC block may be read by placing its PSN in the Address field of the CDB. Valid PSNs are 02DE80h through 02EEBFh and 02EFC0h through 02EFFFh. If the Address field contains any other PSN, the command shall be terminated with CHECK CONDITION and sense data shall be set to ILLEGAL REQUEST/INVALID FIELD IN CDB.

The format of returned data for Format Code 31h is shown in Table 432.

Table 432 — READ DISC STRUCTURE Data Format (Format field = 31h)

Bit	7	6	5	4	3	2	1	0	
Byte									
0	(MSB) DISC STRUCTURE Data Length								
1									(LSB)
2	Reserved								
3	Reserved								
MTA Block Data									
0 ... 32 767	Addressed MTA ECC Block data								

6.23.3.2.30 Format Code 80h: AACS volume identifier

Format code 80h returns the AACS Volume Identifier.

Table 433 — READ DISC STRUCTURE Data Format (With Format field = 80h)

Bit	7	6	5	4	3	2	1	0
Byte								
0	(MSB) DISC STRUCTURE Data Length							
1								(LSB)
2	Reserved							
3	Reserved							
Volume Identifier Structure								
0	Volume Identifier Data							
1								
...								
N								

The DISC STRUCTURE Data Length field indicates the length in bytes of the following DISC STRUCTURE data that is available to be transferred to the host. The DISC STRUCTURE Data Length value does not include the DISC STRUCTURE Data Length field itself.

The Volume Identifier Data field returns the Volume Identifier of AACS, which integrity is ensured by the AACS Authentication.

When the Drive is not in the Bus Key established state of the AACS Authentication, this command with Format Code = 80h shall be terminated with CHECK CONDITION status and sense bytes SK/ASC/ASCQ shall be set to ILLEGAL REQUEST/COPY PROTECTION KEY EXCHANGE FAILURE - KEY NOT ESTABLISHED.

6.23.3.2.31 Format Code 81h: Pre-Recorded AACS media serial number

Format code 81h returns the AACS Media Serial Number that is pre-recorded on discs that are able to support AACS.

Table 434 — READ DISC STRUCTURE Data Format (With Format field = 81h)

Bit	7	6	5	4	3	2	1	0	
Byte									
0	(MSB) DISC STRUCTURE Data Length								
1								(LSB)	
2	Reserved								
3	Reserved								
Pre-recorded Media Serial Number Structure									
0	Pre-recorded Media Serial Number Data								
1									
...									
N									

The DISC STRUCTURE Data Length field indicates the length in bytes of the following DISC STRUCTURE data that is available to be transferred to the host. The DISC STRUCTURE Data Length value does not include the DISC STRUCTURE Data Length field itself.

The Pre-recorded Media Serial Number Data field returns the Pre-recorded Media Serial Number of AACS, which integrity is ensured by the AACS Authentication.

When the Drive is not in the Bus Key established state of the AACS Authentication, this command with Format Code = 81h shall be terminated with CHECK CONDITION status and sense bytes SK/ASC/ASCQ shall be set to ILLEGAL REQUEST/COPY PROTECTION KEY EXCHANGE FAILURE - KEY NOT ESTABLISHED.

6.23.3.2.32 Format Code 82h: AACS media identifier

Format 82h returns the AACS Media Identifier.

Table 435 — READ DISC STRUCTURE Data Format (With Format field = 82h)

Bit	7	6	5	4	3	2	1	0	
Byte									
0	(MSB) DISC STRUCTURE Data Length								
1									(LSB)
2	Reserved								
3	Reserved								
Media Identifier Structure									
0	Media Identifier Data								
1									
...									
N									

The DISC STRUCTURE Data Length field indicates the length in bytes of the following DISC STRUCTURE data that is available to be transferred to the host. The DISC STRUCTURE Data Length value does not include the DISC STRUCTURE Data Length field itself.

The Media Identifier Data field returns the Media Identifier of AACS, which integrity is ensured by the AACS Authentication.

When the Drive is not in the Bus Key established state of the AACS Authentication, this command with Format Code = 82h shall be terminated with CHECK CONDITION status and sense bytes SK/ASC/ASCQ shall be set to ILLEGAL REQUEST/COPY PROTECTION KEY EXCHANGE FAILURE - KEY NOT ESTABLISHED.

6.23.3.2.33 Format Code 83h: AACS media key block

Format 83h returns the requested Media Key Block Pack of Media Key Block in Lead-in specified by AACS. The Address field in the CDB specifies which of the available Media Key Block Packs shall be read.

Table 436 — READ DISC STRUCTURE Data Format (With Format field = 83h)

Bit Byte	7	6	5	4	3	2	1	0
0	(MSB) DISC STRUCTURE Data Length							(LSB)
1								
2	Reserved							
3	Total Packs							
Media Key Block Structures								
0	Media Key Block Pack Data							
1								
...								
N								

The DISC STRUCTURE Data Length field indicates the length in bytes of the following DISC STRUCTURE data that is available to be transferred to the host. The DISC STRUCTURE Data Length value does not include the DISC STRUCTURE Data Length field itself.

The Total Packs field reports the total number of Media Key Block Packs that are available for transfer to the host.

The Media Key Block Pack Data field returns the requested Media Key Block Pack of Media Key Block in Lead-in specified by AACS. The size of Media Key Block Pack Data is 32 KB maximum.

This command with Format Code = 83h does not require the AACS Authentication.

6.23.3.2.34 Format Code 90h: List of recognized format layers

Format code 90h returns information about the format-layer structure of a hybrid disc.

Table 437 — READ DISC STRUCTURE Data Format (With Format field = 90h)

Bit Byte	7	6	5	4	3	2	1	0
0	(MSB) DISC STRUCTURE Data Length							
1	(LSB)							
2	Reserved							
3	Reserved							
Hybrid Disc Information								
0	Number of recognized format layers							
1	Reserved		Default Format-layer		Reserved		Online Format-layer	
2	(MSB) Type code of Format-layer #0							
3	(LSB)							
4	(MSB) Type code of Format-layer #1							
5	(LSB)							
...	...							
2*N+2	(MSB) Type code of Format-layer #N							
2*N+3	(LSB)							

The DISC STRUCTURE Data Length field indicates the length in bytes of the following DISC STRUCTURE data that is available to be transferred to the host. The DISC STRUCTURE Data Length value does not include the DISC STRUCTURE Data Length field itself.

The Number of recognized Format-layers field indicates the number of Format-layers that the Drive has identified in the mounted disc. The identified Format-layers are listed in the Type of Format-layer #n fields.

The Default Format-layer field indicates the Format-layer number which becomes online when the disc is inserted. The selection of the Format-layer number to be set in this field is vendor-specific.

The Online Format-layer field indicates the current online Format-layer number or the Format-layer number that is going to be online.

The Type of Format-layer #n field indicates the type of the Format-layer numbered n. Each Format-layer identified by the Drive shall be numbered from 0 and incremented by one. The numbering of the Format-layer shall be in numerical ascending order of the Format-layer type code defined in Table 438. The Format-layer which exists on the disc but is not identified by the Drive shall not be listed.

Table 438 — Format-layer Type Code Definitions

Value	Type Definition
0000h – 0007h	Reserved
0008h	CD
0009h – 000Fh	Reserved
0010h	DVD
0011h – 003Fh	Reserved

Value	Type Definition
0040h	BD
0041h – 004Fh	Reserved
0050h	HD DVD
0051h - FFFFh	Reserved

6.23.3.3 BD Disc Structures

When Media Type = 0001b, Format field values 00h through BFh define disc structures that are specific to BD. Defined BD Format Codes are listed in Table 439.

Table 439 — BD Format Code Definitions

Format Code	Structure	Address	Layer Number	Description
00h	DI	-	-	Disc Information from PIC in Embossed area <ul style="list-style-type: none"> • Address field is reserved • Layer field is reserved
01h — 07h	Reserved	-	-	-
08h	DDS	-	-	Disc Definition Structure
09h	Cartridge Status	-	-	Cartridge status.
0Ah	Spare Area Information	-	-	Status of Spare Areas
0Bh - 11h	Reserved	-	-	-
12h	Raw DFL	Offset	-	Unmodified DFL
13h — 2Fh	Reserved	-	-	-
30h	PAC	ID and Format Number	-	Physical Access Control Structure
31h — BFh	Reserved	-	-	-

6.23.3.3.1 Format Code 00h: Disc Information (DI)

Disc Information and Emergency Brake data shall be read from the PIC zone. DI units that contain physical information shall be returned. Emergency Brake data shall be returned. If it is possible to return any data, 4 100 bytes shall be returned. The Disc Information structure format is shown in Table 440.

Table 440 — BD Structure Format Code 00h: Disc Information

Bit Byte	7	6	5	4	3	2	1	0
0	(MSB) Data Structure Length = 4 098							
1	(LSB)							
2	Reserved							
3	Reserved							
Disc Information								
0	Disc Information Data							
1								
...								
4095								

The format of the Disc Information Data is shown in Table 441.

Table 441 — Disc Information Data Format

Fields	BD-ROM Field Size	BD-R/RE Field Size
Disc Information (DI) Units	2 048	3 584
Emergency Brake (EB) Data	2 048	512

The general format of a DI unit is shown in Table 442.

Table 442 — General DI Unit Format

	DI Unit on ROM		DI Unit on R/RE		Field
	Offset	Size	Offset	Size	
Header	0	2	0	2	Disc Information Identifier "DI"
	2	1	2	1	Disc Information Format
	3	1	3	1	Number of DI units in each DI block
	4	1	4	1	Reserved (each byte set to 00h)
	5	1	5	1	DI unit Sequence Number
	6	1	6	1	Number of bytes in use in this DI unit
	7	1	7	1	Reserved (each byte set to 00h)
Body	8	3	8	3	Disc Type Identifier = "BDO" for BD-ROM, "BDW" for BD-RE, "BDR" for BD-R
	11	1	11	1	Disc Size/Class/Version
	12	52	12	100	DI Unit Format dependent contents
Trailer	-	-	100	6	Disc Manufacturer ID
	-	-	106	3	Media Type ID
	-	-	109	2	Time Stamp
	-	-	111	1	Product Revision Number

The DI Unit Format dependent contents are disc specific. For detailed definition of the BD-ROM DI unit, see [BD-Ref1]. For detailed definition of the BD-R DI unit, see [BD-Ref2]. For detailed definition of the BD-RE DI unit, see [BD-Ref3].

6.23.3.3.2 Format Code 08h: Disc Definition Structure (DDS)

The DDS is a disc management structure that contains basic disc usage parameters for BD-R and BD-RE. The minimum defined size for the DDS is 60 bytes. The DDS definition is permitted to expand to 2048 bytes.

There is no DDS defined for BD-ROM. If the DDS is requested for any disc that has no DDS defined, the command shall be terminated with CHECK CONDITION status and sense bytes SK/ASC/ASCQ shall be set to ILLEGAL REQUEST/INVALID FIELD IN CDB.

On BD-RE, the DDS is written into the DMA zones. See [BD-Ref3] for detailed format of the DDS.

On BD-R, the DDS is written only when the disc is finalized. Prior to finalization, the DDS is represented by the TDDS that is recorded in a TDMA. If the disc is not finalized, the structure returned shall be the most recent version found in the current TDMA. See [BD-Ref2] for detailed format of the DDS on BD-R.

The DDS structure format is shown in Table 443.

Table 443 — BD Structure Format Code 08h: Disc Definition Structure

Bit Byte	7	6	5	4	3	2	1	0
0	(MSB) Data Structure Length							
1	(LSB)							
2	Reserved							
3	Reserved							
Disc Definition Structure								
0	DDS Data							
1								
...								
N-1								

The general format of the DDS is shown in Table 444.

Table 444 — Format of the DDS

Byte Offset	Field	Number of Bytes	Byte Offset	Field	Number of Bytes
0	(T)DDS Identifier "DS"	2	44	OSA size	4
2	DDS format	1	48	ISA1 size	4
3	Reserved	1	52	Spare Area full flags	1
4	DDS Update Count	4	53	Reserved	1
8	Reserved	8	54	Disc Type specific field	1
16	First PSN of Drive Area	4	55	Reserved	1
20	Reserved	4	56	Disc Type specific field	4
24	First PSN of Defect List	4	60	Reserved	4
28	Reserved	4	64	Status bits of INFO1/2 and PAC1/2 on L0 and L1	32
32	PSN of LSN 0 of user area	4	96	Disc Type specific data	...
36	PSN of Last LSN of user area	4			
40	ISA0 size	4			

6.23.3.3.3 Format Code 09h: Cartridge Status

The Medium Status structure (Table 445) includes information about cartridge status.

Table 445 — BD Format Structure Code 09h: Cartridge Status

Bit Byte	7	6	5	4	3	2	1	0
0	(MSB) Data Structure Length = 6 (LSB)							
1								
2	Reserved							
3	Reserved							
Medium Status Structure								
0	Cartridge	OUT	Reserved			CWP	Reserved	
1	Reserved							
2	Reserved							
3	Reserved							

The Cartridge bit of one indicates that a medium is in a cartridge. The Cartridge bit of zero indicates that a medium is not in a cartridge.

The Out bit of one indicates that a medium has been taken out from a cartridge or a medium is put into a cartridge. The Out bit of zero indicates that a medium has not been taken out from a cartridge. This field is valid only when the Cartridge bit is set to one. If the Cartridge bit is set to zero, the Out bit shall be set to zero.

The Media Cartridge Write Protection (CWP) bit of one indicates that the write protect switch/tabs on a cartridge is set to write protected state. The CWP bit of zero indicates that the write protect switch/tabs on a cartridge is set to write permitted state. This field is valid only when the Cartridge bit is set to one. If the Cartridge bit is set to zero, the CWP bit shall be set to zero.

6.23.3.3.4 Format Code 0Ah: Spare Area Information

The Spare Area Information structure contains status information about the defect management systems spare blocks on BD-R and BD-RE discs. The format of the Spare Area Information structure is shown in Table 446.

Table 446 — Format Code 0Ah: Spare Area Information

Bit Byte	7	6	5	4	3	2	1	0
0	(MSB) Data Structure Length = 000Eh							
1	(LSB)							
2	Reserved							
3	Reserved							
Spare Area Information								
0	(MSB) Reserved							
...								
3	(LSB)							
4	(MSB) Number of Free Spare Blocks							
...								
7	(LSB)							
8	(MSB) Number of Allocated Spare Blocks							
...								
11	(LSB)							

Number of free Spare blocks field is the number of unused spare blocks that are not considered defective in the Spare Areas. In the case of BD-R/-RE, this number is an integral multiple of 32.

Number of Allocated Spare blocks is the number of spare blocks reserved on the disc for defective block replacements. In the case of BD-R/-RE, this number is an integral multiple of 32. If the disc is BD-R formatted as SRM, this value does not include any part of the spare areas that have been allocated as TDMA's.

6.23.3.3.5 Format Code 12h: Raw Defect List (DFL)

The DFL is a defect management structure on BD-R and BD-RE discs that identifies the locations and status of known defective Clusters on the disc. There is no DFL defined for BD-ROM. If the DFL is requested for any disc that has no DFL defined, the command shall be terminated with CHECK CONDITION status and sense bytes SK/ASC/ASCQ shall be set to ILLEGAL REQUEST/INVALID FIELD IN CDB.

The DFL is a defect management structure that identifies the locations and status of known defective Clusters on the disc. The length of the DFL is variable. The minimum defined size is 72 bytes. The DFL may occupy as many as 8 Clusters (524 288 bytes). The actual length of the DFL is recorded in the DFL header.

On BD-R, the DFL is written only when the disc is finalized. Prior to finalization, the DFL is represented by the TDFL that is recorded in a TDMA. If the disc is not finalized, the structure returned shall be the most recent version found in the current TDMA.

The DFL is viewed as being contained within 16 packages (numbered from 0 through 15), each 32K (32 768) bytes in length. The 64-byte DFL header appears only in package 0. The Address field in the CDB is used to address a specific package. If the Address field value is larger than 15, the command shall be terminated with CHECK CONDITION and sense bytes SK/ASC/ASCQ shall be set to indicate ILLEGAL REQUEST/INVALID FIELD IN CDB. It is only possible to read a single package with one command. In order to read the entire DFL it is necessary to read all of the DFL packages.

The DFL structure format is shown in Table 447.

Table 447 — BD Structure Format Code 12h: Defect List

Bit	7	6	5	4	3	2	1	0
Byte								
0	(MSB) Data Structure Length							
1								(LSB)
2	Reserved							
3	Number of Packages in DFL							
Defect List Structure								
0	DFL Data from addressed package							
1								
...								
N-1								

The Host is required to read packages 0 through "Number of Packages in DFL" - 1 in order to receive all of the DFL.

The Data Structure Length is the number of bytes that follow the Data Structure Length field. The maximum value for this field is 32770 (a complete package + 2). If Data Structure Length = 0002h, the addressed DFL package is empty.

The general DFL format is shown in Table 448.

Table 448 — General DFL Format

Field Offset	Contents	Field Size
0	DFL Identifier "DL"	2
2	DFL format	1
3	Reserved	1
4	DFL Update Count	4
8	Reserved	4
12	Number of DFL Entries	4
16	Disc Type Specific information	48
64	Defect Entries - eight bytes each	...

See [BD-Ref2] for detailed format of the DFL on BD-R. See [BD-Ref3] for detailed format of the DFL on BD-RE.

6.23.3.3.6 Format Code 30h: Physical Access Control (PAC)

6.23.3.3.6.1 General

Physical Access Control (PAC) Clusters are provided as structures on the disc to include additional information for interchange between interchange parties. PAC Clusters shall be recorded in the INFO1/PAC1 Area. Backup copies shall be recorded in the INFO2/PAC2 Area. The format for all PACs is shown in Table 59.

The specific PAC ID and format number of the PAC addressed by the READ DISC STRUCTURE command is contained the Address field of the CDB as shown in Table 449.

Table 449 — PAC ID and Format Number in CDB Address Field

Byte	Field
2	(MSB)
3	PAC ID
4	(LSB)
5	Format Number

Valid values for the PAC ID and Format Number fields are shown in Table 450.

Table 450 — PAC ID and Format Number Fields

PAC		Definition
ID	Format	
000000h	00h	Return a list of PAC headers of all PACs that are written on the currently mounted disc. The list shall be given in ascending order according to PAC ID.
	01h - FFh	Reserved
000001h - FFFFFEh	00h - FFh	The PAC information of the addressed PAC shall be returned.
FFFFFFh	00h - FEh	Reserved
	FFh	Return a list of PAC headers of all PACs that are known to the Drive for the currently mounted disc type. The list shall be given in ascending order according to PAC ID.

In the case that the PAC ID and Format Number requested are both zero, the Drive shall return a list of the headers of all PACs that are written on the currently mounted disc. The PAC headers shall be ordered according to PAC ID.

Table 451 — Returned Data Format for PAC ID/Format = 000000h/00h

Bit	7	6	5	4	3	2	1	0
Byte								
0	(MSB) Data Structure Length = 384*N+2							(LSB)
1								
2	Reserved							
3	Reserved							
PAC Header List								
0	Header of first written PAC							
...								
383								
384	...							
...								
384*(N-1)								
...	Header of Nth written PAC							
384*N-1								

In the case that the PAC ID/Format Number requested is neither 000000h/00h nor FFFFFFFh/FFh, the Drive shall return the most recently recorded copy of the requested PAC. If reading the PAC is not permitted, then only the PAC header shall be returned. If there is no PAC with the specified ID and Format Number, the command shall be terminated with CHECK CONDITION status and sense bytes SK/ASC/ASCQ shall be set to indicate ILLEGAL REQUEST/INVALID FIELD IN CDB. The format of returned PAC data is shown in Table 452.

Table 452 — Returned Data Format for 000001h ≤ PAC ID ≤ FFFFFFFh

Bit	7	6	5	4	3	2	1	0
Byte								
0	(MSB) Data Structure Length							(LSB)
1								
2	Reserved							
3	Reserved							
PAC								
0	PAC Header							
...								
383								
384	PAC Specific Information							
...								
N-1								

The length of a PAC is at most 63488 bytes (31 logical blocks).

In the case that the PAC ID requested is FFFFFFFFh, the Drive shall return a list of the PAC IDs of all PACs that are known to the Drive. The list shall be ordered according to PAC ID in ascending order.

Table 453 — Returned Data Format for PAC ID = FFFFFFFFh

Bit	7	6	5	4	3	2	1	0
Byte								
0	(MSB)							Data Structure Length = $4*(N-1)+2$
1								(LSB)
2	Reserved							
3	Reserved							
PAC Header List								
0	PAC ID and Format of first known PAC							
...								
3								
4	...							
...								
...								
$4*(N-2)$	PAC ID and Format of Nth known PAC							
...								
$4*(N-1)-1$								

6.23.3.3.6.2 Primary PAC

The Primary PAC (PAC ID = 50524Dh ("PRM"), PAC Format = 00h) shall be included on each BD-ROM and BD-RE. The Primary PAC is not defined for BD-R.

See [BD-Ref1] for detailed format of the Primary PAC on BD-ROM. See [BD-Ref3] for detailed format of the Primary PAC on BD-RE.

The format of the Primary PAC structure is shown in Table 454.

Table 454 — Primary PAC

Bit Byte	7	6	5	4	3	2	1	0
0	(MSB) Data Structure Length = N+2 (LSB)							
1								
2	Reserved							
3	Reserved							
Primary PAC Data								
0	PAC Data							
1								
...								
N-1								

The maximum value for N is 404 on BD-ROM and 32 768 on BD-RE.

6.23.3.3.6.3 Disc Write Protect PAC

The Disc Write Protect (DWP) PAC Cluster is used to protect a disc against unintended write actions or write actions by unauthorized persons. For the case where the disc is protected against write actions by unauthorized persons, a password **may** be included. Recognition and reading the DWP PAC is mandatory. The format of the Disc Write Protect PAC structure is shown in Table 455.

Table 455 — DWP PAC

Bit Byte	7	6	5	4	3	2	1	0
0	(MSB) Data Structure Length = 430 (LSB)							
1								
2	Reserved							
3	Reserved							
DWP PAC Data								
0	DWP PAC Header							
1								
...								
383								
384	Known PAC Entire_Disc_Flags							
385	Reserved							
386	Reserved							
387	Reserved							
388	Write Protect Control Byte (see Table 60)							
389 - 395	Reserved							
396 - 427	Write Protect Password							

The Write Protect Password field is zero filled prior to transfer of this structure.
The length of a DWP PAC is 428 bytes.

6.23.4 Timeouts

The READ DISC STRUCTURE command belongs to timeout group 1. If the command is terminated with CHECK CONDITION status due to a timeout, sense bytes SK/ASC/ASCQ shall be set to UNIT ATTENTION/INSUFFICIENT TIME FOR OPERATION.

6.23.5 Error Reporting

Recommended error reporting for the READ DISC STRUCTURE command is defined in Table 456.

Table 456 — Recommended errors for READ DISC STRUCTURE Command

Error	Reference
Unit Attention conditions	Table F.1
CDB or parameter list validation errors	Table F.2
Readiness errors	Table F.3
General media access errors	Table F.5
Read errors	Table F.6
Hardware failures	Table F.8

6.24 READ FORMAT CAPACITIES Command

6.24.1 Introduction

The READ FORMAT CAPACITIES command allows the Host to request a list of the possible format capacities for an installed writable media. This command also has the capability to report the writable capacity for a media when it is installed. For readable capacity, see 6.19, READ CAPACITY Command. If the command is required, by an implemented Feature it shall function independently of the state of that Feature's Current bit.

Table 457 shows the Features associated with the READ FORMAT CAPACITIES command.

Table 457 — Features Associated with the READ FORMAT CAPACITIES Command

Feature Number	Feature Name	Command Requirement
0023h	Formattable	Mandatory
0028h	MRW	Mandatory

6.24.2 The CDB and Its Parameters

6.24.2.1 The CDB

The READ FORMAT CAPACITIES CDB is shown in Table 458.

Table 458 — READ FORMAT CAPACITIES CDB

Bit Byte	7	6	5	4	3	2	1	0
0	Operation Code (23h)							
1	Reserved							
2	Reserved							
3	Reserved							
4	Reserved							
5	Reserved							
6	Reserved							
7	(MSB)				Allocation Length			
8	(LSB)							
9	Control							

6.24.2.2 Allocation Length

The Allocation Length field specifies the maximum number of bytes that A Host has allocated for returned data. An Allocation Length of zero indicates that no data shall be transferred. This condition shall not be considered as an error. The Drive shall terminate the data transfer when Allocation Length bytes have been transferred or when all available data have been transferred to the Host, whatever is less.

6.24.3 Command Processing

The Drive shall construct a set of data structures that shall be transferred to the Host. The format of this returned data is a 4-byte header followed by some non-zero number of 8-byte format descriptors as shown in Table 459.

Table 459 — READ FORMAT CAPACITIES Data Format

Bit Byte	7	6	5	4	3	2	1	0
0 – 3	Capacity List Header							
4 – 11	Current/Maximum Capacity Descriptor							
Formattable Capacity Descriptor(s)								
0	Formattable Capacity Descriptor 0							
..								
7								
....	Formattable Capacity Descriptor n							
0								
..								
7								

6.24.3.1 Capacity List Header

The Capacity List Header precedes all other returned data.

Table 460 — Capacity List Header

Bit Byte	7	6	5	4	3	2	1	0
0	Reserved							
1	Reserved							
2	Reserved							
3	Capacity List Length							

The Capacity List Length specifies the length in bytes of the available Capacity Descriptors that follow. Each Capacity Descriptor is eight bytes in length, making the Capacity List Length equal to eight times the number of descriptors. Values of $n * 8$ are valid, where $0 < n < 32$.

6.24.3.2 Current/Maximum Capacity Descriptor

The Current/Maximum Capacity Descriptor shall appear after the header.

Table 461 — Current/Maximum Capacity Descriptor

Bit Byte	7	6	5	4	3	2	1	0
4	(MSB) Number of Blocks							(LSB)
5								
6								
7								
8	Reserved					Descriptor Type		
9	(MSB) Block Length							(LSB)
10								
11								

The Number of Blocks indicates the number of addressable blocks for the capacity defined by each Descriptor Type.

The Descriptor Type field (Table 462) indicates the type of information the descriptor contains.

The Block Length specifies the length in bytes of each logical block.

Table 462 — Descriptor Types

Descriptor Type	Description
00b	Reserved
01b	Unformatted Media. The reported value is for the maximum formatted capacity for this media. See Table 463.
10b	Formatted Media. The reported value is the current media's capacity. In the case of sequential writable media, the number of blocks field indicates the number of blocks between the first Lead-in and the last Lead-out/Border-out. When the media does not have a complete session it shall be reported as "No Media Present" with Descriptor Type = 11b.
11b	No Media Present. The reported value is for the maximum capacity of a media that the Drive is capable of reading.

Table 463 — Returned Current/Maximum Descriptor for Combination of Drive and Media

Drive Type	No Media	ROM Media	Sequential Writable Media	Random Writable Media
ROM	Descriptor Type = 11h	Descriptor Type = 10h	Descriptor Type = 10h or 11h	Descriptor Type = 10h
Sequential Writable			Descriptor Type = 10h	Descriptor Type = 10h
Random Writable			Descriptor Type = 10h or 11h	Descriptor Type = 01h or 10h plus Formattable Capacity Descriptor(s)

6.24.3.3 Formattable Capacity Descriptors

The Drive shall only return Formattable Capacity Descriptors that apply to the installed media. If there is no medium installed, the Drive shall return only the Current/Maximum Capacity Descriptor, with the maximum capacity of a medium that the Drive is capable of reading.

A Formattable Capacity Descriptor of Format Type 00h shall be reported if any other Formattable Capacity Descriptor is reported. Although the Drive may not support formatting type 0 (e.g. CD-RW), the descriptor is reported for the purpose of reporting the recordable capacity of sequentially recorded media.

The descriptors shall be returned in ascending order of Format Type. For Format Types other than 04h and 05h, if multiple format descriptors exist, they shall be returned in Drive preferred order. For Format Types 04h and 05h, the format descriptors shall be returned in ascending order of Zone number.

Formattable Capacity Descriptors for formats that may be read, but not formatted shall not be reported.

If the Drive supports writing on the mounted media, the appropriate Formattable Capacity Descriptors shall be appended, sorted by Format Type. The general format of a Formattable Capacity Descriptor is shown in Table 464.

Table 464 — Formattable Capacity Descriptor Format

Bit Byte	7	6	5	4	3	2	1	0
0	(MSB) Number of Blocks							
1								
2								
3								
4	Format Type					Reserved		
5	(MSB) Type Dependent Parameter							
6								
7								

The Format Type field,

Table 465 is the type of information required for formatting.

Table 465 — Format Types

Format Type	Description	Type Dependent Parameter
00h	<p>The descriptor shall contain the number of addressable blocks and the block size used for formatting the whole media. If multiple formatting for the whole media is possible, each capacity/block size combination shall be reported as a separate descriptor.</p> <p>When the currently mounted media is a blank BD-R disc, all parameters in the descriptor are vendor selected default values for BD-R discs.</p> <p>When the currently mounted media is a BD-RE disc, all parameters in the descriptor are vendor selected default values for BD-RE discs. The following are recommended Spare area distributions:</p> <p>For 80mm SL BD-RE discs: ISA0 size = 4096 Clusters and OSA0 size = 0 Clusters.</p> <p>For 80mm DL BD-RE discs: ISA0 size = ISA1 size = 4096 Clusters and OSA0 size = OSA1 size = 0 Clusters.</p> <p>For 120mm SL BD-RE discs: ISA0 size = 4096 Clusters and OSA0 size = 8192 Clusters.</p> <p>For 120mm DL BD-RE discs: ISA0 size = ISA1 size = 4096 Clusters and OSA0 size = OSA1 size = 8192 Clusters.</p>	Block length in bytes
01h	The descriptor shall contain the number of addressable blocks and the block size used for formatting the whole media. If multiple formatting for the whole media is possible, each capacity/block size combination shall be reported as a separate descriptor. This Format Type is used to expand a Spare area.	Block length in bytes
02h – 03h	Reserved	
04h	The descriptor shall contain the number of addressable blocks in the zone and zone number used by zoned formatting for a zone of the media, where the size of zone is not constant for each zone. The information for each zone shall be reported as a separate descriptor.	Zone number of the description
05h	The descriptor shall contain the number of addressable blocks per zone and zone number of the highest numbered zone. This descriptor is used for zoned formatting of the media, where the size of zone is constant for each zone.	Zone number of the last zone
06h – 0Fh	Reserved	
10h	The descriptor shall contain the maximum number of addressable blocks and maximum packet size that may be used to fully format CD/DVD-RW media. The packet size and number of addressable blocks may be adjusted downward by the Host before sending this descriptor back via the FORMAT UNIT command.	Fixed Packet Size in sectors/ECC block size in sectors
11h	The descriptor shall contain the maximum number of addressable blocks and the packet size that may be used to expand (grow) the last complete session of CD/DVD-RW media. The number of addressable blocks may be adjusted downward by the Host before sending this descriptor back via the FORMAT UNIT command.	Fixed Packet Size in sectors/ECC block size in sectors
12h	The descriptor shall contain the maximum number of addressable blocks and the maximum packet size that may be used to add a new session to a CD/DVD-RW media. The packet size and number of addressable blocks may be adjusted downward by the Host before sending this descriptor back via the FORMAT UNIT command.	Fixed Packet Size in sectors/ECC block size in sectors

Table 465 — Format Types (continued)

Format Type	Description	Type Dependent Parameter
13h	The descriptor shall contain the maximum number of addressable blocks and the ECC block size that may be used to expand (grow) the last complete Session of a DVD-RW media as an intermediate state. The Host may adjust the number of addressable blocks downward before sending this descriptor back via the FORMAT UNIT command.	ECC block size in sectors
14h	The descriptor shall contain the maximum number of addressable blocks and the ECC block size that may be used to add a new intermediate state Session to a DVD-RW media. The number of addressable blocks may be adjusted downward by the Host before sending this descriptor back via the FORMAT UNIT command.	ECC block size in sectors
15h	The descriptor shall contain the maximum number of addressable blocks and ECC block size that may be used to fully format DVD-RW media as an intermediate state. The number of addressable blocks may be adjusted downward by the Host before sending this descriptor back via the FORMAT UNIT command.	ECC block size in sectors
16h	No descriptor is reported. This format type is used for extending the Test Zone on HD DVD-R media.	Set to zeros.
17h – 1Fh	Reserved	
20h	The descriptor shall contain the maximum number of addressable blocks and the sparing parameters to be used. M specifies SL where $SL = 2^M$, $4 \leq M \leq 15$ or $SL = 0$ if $M = 0$ and N identifies SI where $SI = 2^N$, $4 \leq N \leq 24$. The Type Dependent Parameter is set to $M * 10000h + N$, effectively placing M in byte offset 5 and N in byte offset 7. The Drive shall supply its default values for M and N.	M and N (sparing parameters)
24h	MRW Format, Mandatory for the MRW Feature. The descriptor shall contain the maximum number of DMA addressable blocks.	Set to zeros.
26h	DVD+RW Full Format, Mandatory for the DVD+RW Profile	Set to zeros.
25h – 2Fh	Reserved	
30h (BD-RE)	The descriptor shall contain the total number of addressable blocks and the total number of Spare Area size used for formatting the whole media. Three descriptors are reported: The first descriptor values are vendor preferred for the BD device. The second descriptor values are selected to reflect maximum Spare Area sizes: For 80mm SL BD-RE discs, ISA0 size = 4096 Clusters and OSA0 size = 0 Clusters. For 80mm DL BD-RE discs, ISA0 size = 4096 Clusters, ISA1 size = 16384 Clusters and OSA0 size = OSA1 size = 0 Clusters. For 120mm SL BD-RE discs, ISA0 size = 4096 Clusters and OSA0 size = 16384 Clusters. For 120mm DL BD-RE discs, ISA0 size = 4096 Clusters, OSA0 size = OSA1 size = 8192 Clusters, and ISA1 size = 16384 Clusters. The third descriptor values are selected to reflect minimum Spare Area size. For 80mm, 120mm SL and DL BD-RE discs, ISA0 size = 4096 and ISA1 size = OSA0 size = OSA1 size = 0 Clusters.	Total Spare Area size in Clusters

Table 465 — Format Types (continued)

Format Type	Description	Type Dependent Parameter
31h (BD-RE)	The descriptor shall contain the total number of addressable blocks and the block size used for formatting the whole media. All parameters in the descriptor are for the format with no Spare Area. By using this parameter in FORMAT UNIT command, the Hardware Defect Management Feature (and consequently, Removable Disk Profile) becomes not Current.	Block length in bytes
32h (BD-R)	The descriptor shall contain the total number of addressable blocks. Three descriptors are reported: <ol style="list-style-type: none"> 1. The first descriptor values are vendor preferred for the BD device. 2. The second descriptor values are selected to reflect maximum Spare Area sizes, resulting in minimum User Data Zone size. 3. The third descriptor values are selected to reflect minimum (but non-zero) Spare Area size, resulting in maximum User Data Zone size. In each case total Spare Area size is: Data Zone size – Number of Blocks. Data Zone size is given in the number of blocks parameter of the maximum capacity descriptor for unformatted media.	The Type Dependent Parameter specifies fractional usage of the spare areas (see 6.5.4.2.17)
33h – 3Fh	Reserved	

The Number of Blocks field indicates the number of addressable blocks for the capacity defined by each Format Type.

The Type Dependent Parameter contents are as specified for each Format Type in Table 465.

6.24.4 Timeouts

The READ FORMAT CAPACITIES command belongs to timeout group 1. If the command is terminated with CHECK CONDITION status due to a timeout, sense bytes SK/ASC/ASCQ shall be set to UNIT ATTENTION/INSUFFICIENT TIME FOR OPERATION.

6.24.5 Error Reporting

Recommended error reporting for the READ FORMAT CAPACITIES command is defined in Table 466.

Table 466 — Recommended errors for READ FORMAT CAPACITIES Command

Error	Reference
Unit Attention conditions	Table F.1
CDB or parameter list validation errors	Table F.2
General media access errors	
Hardware failures	Table F.8

6.25 READ TOC/PMA/ATIP Command

6.25.1 Introduction

The READ TOC/PMA/ATIP command requests that the Drive read data from a Table of Contents, the Program Memory Area (PMA), or the Absolute Time in Pre-Grove (ATIP) from CD media, format according to CDB parameters and transfer the result to the Host.

For media other than CD, information may be fabricated in order to emulate a CD structure for the specific media.

Table 467 shows the Features associated with the READ TOC/PMA/ATIP command.

Table 467 — Features Associated with the READ TOC/PMA/ATIP Command

Feature Number	Feature Name	Command Requirement
001Eh	CD Read	Format Codes 0, 1, 2 and conditionally 5
001Fh	DVD Read	Format codes 0 and 1
0103h	CD Audio External Play	Format codes 0 and 1

6.25.2 The CDB and Its Parameters

6.25.2.1 The CDB

The READ TOC/PMA/ATIP CDB is shown in Table 468.

Table 468 — READ TOC/PMA/ATIP CDB

Bit Byte	7	6	5	4	3	2	1	0
0	OPERATION CODE (43h)							
1	Reserved						MSF	Reserved
2	Reserved				Format			
3	Reserved							
4	Reserved							
5	Reserved							
6	Track/Session Number							
7	(MSB)				Allocation Length			
8	(LSB)							
9	Control							

6.25.2.2 MSF

When MSF is set to zero, the address fields in some returned data formats shall be in LBA form. When MSF is set to one, the address fields in some returned data formats shall be in MSF form. For specific cases, see Table 469.

6.25.2.3 Format

The Format field is used to select specific returned data format. See Table 469.

6.25.2.4 Track/Session Number

The Track/Session Number field provides a method to restrict the returned of some data formats to a specific session or a track range. See Table 469.

6.25.2.5 Allocation Length

The Allocation Length field specifies the maximum number of bytes that may be returned by the Drive. An Allocation Length field of zero shall not be considered an error.

Table 469 — Format Field Values

Format Field	MSF Field	Track/Session Number	Description
0000b	Valid	Valid as a Track Number	The Track/Session Number field specifies starting track number for which the data is returned. For multi-session discs, TOC data is returned for all sessions. Track number AAh is reported only for the Lead-out area of the last complete session.
0001b	Valid	Ignored by Drive	This format returns the first complete session number, last complete session number and last complete session starting address. In this format, the Track/Session Number field is reserved and should be set to 00h. NOTE: This format provides the Host access to the last closed session starting address quickly.
0010b	Ignored by Drive	Valid as a Session Number	This format returns all Q sub-code data in the Lead-In (TOC) areas starting from a session number as specified in the Track/Session Number field. In this mode, the Drive shall support Q Sub-channel POINT field value of A0h, A1h, A2h, Track numbers, B0h, B1h, B2h, B3h, B4h, C0h, and C1h. There is no defined LBA addressing and MSF bit shall be set to one.
0011b	Ignored by Drive	Ignored by Drive	This format returns Q sub-channel data in the PMA area. In this format, the Track/Session Number field is reserved and shall be set to 00h. There is no defined LBA addressing and MSF bit shall be set to one.
0100b	Ignored by Drive	Ignored by Drive	This format returns ATIP data. In this format, the Track/Session Number field is reserved and shall be set to 00h. There is no defined LBA addressing and MSF bit shall be set to one.
0101b	Ignored by Drive	Ignored by Drive	This format returns CD-TEXT information that is recorded in the Lead-in area as R-W Sub-channel Data.
0110b – 1111b	Reserved		

6.25.3 Command Processing

6.25.3.1 Overview

The response data list (see Table 470) shows the general description of the response data to the Read TOC/PMA/ATIP command. Each descriptor field is format specific and is defined in the appropriate format sub-clause.

Table 470 — READ TOC/PMA/ATIP Data list, general definition

Bit Byte	7	6	5	4	3	2	1	0
0	Data Length							
1								
2	First Track/Session/Reserved Field							
3	Last Track/Session/Reserved Field							
Parameter List Descriptor(s)								
0 : n	Descriptor data - format specific							

The Data Length indicates the length, in bytes, of the data list descriptor data.

The Track/Session/Reserved Field is format specific and indicates the location, if any, of the information in the data list descriptors. These numbers are represented as binary values.

Descriptor data fields are format specific. The definitions of the bytes are described in each format sub-clause.

6.25.3.2 Response Format 0000b: Formatted TOC

6.25.3.2.1 General

The response data consist of four header bytes and zero or more track descriptors. The response data is dependent upon the format specified in the format field of the CDB. The response data returned for Format 0000b is specified in Table 471.

Table 471 — READ TOC/PMA/ATIP response data (Format = 0000b)

Byte	Bit	7	6	5	4	3	2	1	0
0	(MSB)	TOC Data Length							
1		(LSB)							
1		(LSB)							
2		First Track Number							
3		Last Track Number							
TOC Track Descriptor(s)									
0		Reserved							
1		ADR				CONTROL			
2		Track Number							
3		Reserved							
4	(MSB)	Track Start Address							
...									
7									

The TOC data length indicates the length in bytes of the following TOC data. The TOC data length value does not include the TOC data length field itself. This value is not modified when the allocation length is insufficient to return all of the TOC data available. All other values within the descriptor shall be in binary representation.

6.25.3.2.2 General Case for CD

The First Track Number field indicates the first track number in the first complete session Table of Contents.

The Last Track Number field indicates the last track number in the last complete session Table of Contents before the Lead-out.

The ADR field gives the type of information encoded in the Q Sub-channel of the block where this TOC entry was found.

The CONTROL Field indicates the attributes of the track.

The Track Start Address contains the address of the first block with user information for that track number as read from the Table of Contents. A MSF bit of zero indicates that the Track Start Address field shall contain a logical block address. A MSF bit of one indicates the Logical Block Address field shall contain a MSF address (see 4.2.3.3).

The Track Number field indicates the track number for that the data in the TOC track descriptor is valid. A track number of AAh indicates that the track descriptor is for the start of the Lead-out area.

6.25.3.2.3 MRW Deviations

If the disc is MRW formatted or in progress with MRW formatting, form 0 of the TOC shall be reported as follows: One track, track number = 1, ADR = 0001b, and CONTROL = 0111b. In the case of CD-MRW, the track start addresses are shown in Table 472. In the case of DVD+MRW, the track start addresses are shown in Table 473.

Table 472 — Track Start Addresses for CD-MRW Discs

LBA Space	MSF bit	Track 1 Start Address	Lead-out Start Address
GAA	1	00:02:00	Regardless of the state of the MRW formatting process, only the final state is reported. The link separating the last GAA packet and the first DMA packet is reported: 00:18:43.
GAA	0	0	1 024
DMA	1	00:18:47	Regardless of the state of the MRW formatting process, only final state is reported. The absolute address of the final state link block separating the last DMA packet and the first STA packet is reported.
DMA	0	0	C+1, where C is the LBA of the last user block of the last packet in the DMA.

Table 473 — Track Start Addresses for DVD+MRW Discs

LBA Space	MSF bit	Track 1 Start Address	Lead-out Start Address
GAA	1	00:02:00	Regardless of the state of the MRW formatting process, only the final state is reported. For the GAA, this address is 00:15:49.
GAA	0	0	1 024
DMA	1	00:02:00	The MSF value shall be 00h, FFh, 3Bh, 4Ah
DMA	0	0	C+1, where C is the LBA of the last user sector of the last ECC block in the DMA.

6.25.3.2.4 DVD-ROM, HD DVD-ROM, DVD-RAM, HD DVD-RAM, DVD+RW, Single Session DVD-R/-RW, Single Session DVD+R, and Single Session HD DVD-R

TOC form 0 data for single session DVD shall be fabricated as shown in Table 474.

Table 474 — Fabrication of TOC Form 0 for Single Session DVD

Byte(s)	Field	Value
0, 1	TOC Data Length	001Ah
2	First Track	01h
3	Last Track	01h
Track 1 Descriptor		
4	Reserved	00h
5	ADR, CONTROL	17h: DVD+R and DVD+MRW 14h: all others
6	Track Number	01h
7	Reserved	00h
8...11	Track Start Address	LBA form = 000000h, MSF form = 00:00:02:00
Track AAh (Lead-out) Descriptor		
12	Reserved	00h
13	ADR, CONTROL	14h: DVD-ROM 17h: Recordables and Rewritables
14	Track Number	AAh
15	Reserved	00h
16...19	Track Start Address	LBA form = Actual start of lead-out, MSF form = MSF translation of LBA with a maximum of MSF address of 00h, FFh, 3Bh, 4Ah

6.25.3.2.5 DVD-R/-RW with Multiple Sessions

DVD-R/-RW may have multiple sessions. Since the number of sessions may be rather large, only two sessions are represented as tracks: the last session is seen as the last user track. All earlier sessions are concatenated into a single logical track to be referred to as track 1. TOC form 0 shall be fabricated accordingly.

6.25.3.2.6 DVD+R with Multiple Sessions

Due to track merging, TOC form 0 reports each closed session as a track. Since DVD+R supports at most 154 sessions, TOC form 0 may have at most 154 track descriptors. Thus, the maximum size of returned data for TOC form 0 is 1 532 (i.e., 4 + 8*154).

6.25.3.2.7 BD-ROM

A BD-ROM disc is viewed shall be reported as a single track, single session disc. TOC Format 0 shall have the format shown in Table 475.

Table 475 — Response Format 0: Data Returned for BD-ROM disc

	Byte(s)	Field	Value
Header	0, 1	TOC Data Length	0012h
	2	First Track	01h
	3	Last Track	01h
Track 1 Descriptor	4	Reserved	00h
	5	ADR/CTL	14h
	6	Track Number	01h
	7	Reserved	00h
	8-11	Track Start Address	LBA form = 000000h, MSF form = 00:02:00
Track AAh (Lead-out) Descriptor	12	Reserved	00h
	13	ADR/CTL	14h
	14	Track Number	AAh
	15	Reserved	00h
	16 - 19	Track Start Address	LBA form = READ CAPACITY LBA + 1 MSF form = MSF translation of LBA form with a maximum MSF address of 00h, FFh, 3Bh, 4Ah

6.25.3.2.8 Blank BD-RE

A blank BD-RE disc has no structure to report. If the currently mounted media is an unformatted BD-RE, the command shall be terminated with CHECK CONDITION status and sense bytes SK/ASC/ASCQ shall be set to ILLEGAL REQUEST/INCOMPATIBLE MEDIUM INSTALLED.

6.25.3.2.9 Formatted BD-RE

A formatted BD-RE disc shall be reported as a single track, single session disc. TOC Format 0 shall have the format shown in Table 475.

6.25.3.2.10 Blank BD-R

A blank BD-R disc has no structure to report. If the currently mounted media is a blank BD-R, the command shall be terminated with CHECK CONDITION status and sense bytes SK/ASC/ASCQ shall be set to ILLEGAL REQUEST/INCOMPATIBLE MEDIUM INSTALLED.

6.25.3.2.11 BD-R RRM

A BD-R disc formatted in RRM shall be reported as a single track, single session disc. TOC Format 0 shall have the format shown in Table 475.

6.25.3.2.12 BD-R SRM-POW and SRM+POW

The READ TOC/PMA/ATIP command was originally designed for CD media. Since the lead-out is reported as Logical Track AAh (=170, at most 169 Logical Tracks **may** be reported). Accurately adapting this command to BD-R formatted in SRM-POW or SRM+POW cannot be done, so the returned data is fabricated to maximize backward compatibility without being limited by the Logical Track number range.

Based upon format, the disc shall be viewed as shown in Table 476.

Table 476 — BD-R Track Translation for READ TOC/PMA/ATIP

BD-R Format	TOC Fabrication
Blank disc	Terminate the command with CHECK CONDITION status and set SK/ASC/ASCQ values to ILLEGAL REQUEST/INVALID FIELD IN CDB.
SRM-POW, one open session	Terminate the command with CHECK CONDITION status and set SK/ASC/ASCQ values to ILLEGAL REQUEST/INVALID FIELD IN CDB.
SRM-POW, one closed session	The one closed session is Viewed as one track.
SRM-POW, N > 1 Closed Sessions	The concatenation of the first N-1 sessions is viewed as Track 1. Session N (the last closed session) is viewed as Track 2.
SRM+POW	A disc formatted as SRM+POW is viewed as a closed disc with one session. The session is viewed as Track 1.

TOC fabrication for SRM-POW and SRM+POW as shown in Table 477.

Table 477 — Response Format 0: Data Returned for formatted BD-R discs

	Byte(s)	Field	Value
Header	0, 1	TOC Data Length	0012h (or 001Ah if Track 2 Descriptor is present)
	2	First Track	01h
	3	Last Track	01h (or 02h if Track 2 Descriptor is present)
Track 1 Descriptor	4	Reserved	00h
	5	ADR/CTL	14h
	6	Track Number	01h
	7	Reserved	00h
	8-11	Track Start Address	LBA form = 000000h, MSF form = 00:02:00
Track 2 Descriptor (if present)	12	Reserved	00h
	13	ADR/CTL	14h
	14	Track Number	02h
	15	Reserved	00h
	16-19	Track Start Address	LBA form = Start LBA of last closed session. MSF form = MSF translation of LBA form with a maximum MSF address of 00h, FFh, 3Bh, 4Ah
Track AAh (Lead-out) Descriptor	12/20	Reserved	00h
	13/21	ADR/CTL	14h
	14/22	Track Number	AAh
	15/23	Reserved	00h
	16-19/ 24-27	Track Start Address	LBA form = READ CAPACITY LBA + 1 MSF form = MSF translation of LBA form with a maximum MSF address of 00h, FFh, 3Bh, 4Ah

6.25.3.3 Response Format 0001b: Multi-session Information

6.25.3.3.1 General

The response data returned for Format 0001b is specified in Table 478.

Table 478 — READ TOC/PMA/ATIP response data (Format = 0001b)

Bit Byte	7	6	5	4	3	2	1	0
0	(MSB) TOC Data Length (LSB)							
1								
2	First Complete Session Number							
3	Last Complete Session Number							
TOC Track Descriptor								
0	Reserved							
1	ADR				CONTROL			
2	First Track Number In Last Complete Session							
3	Reserved							
4	(MSB) Start Address of First Track in Last Session (LSB)							
...								
7								

The TOC Data Length specifies the length in bytes of the available session data. The TOC Data Length value does not include the TOC Data Length field itself. This value is not modified when the allocation length is insufficient to return all of the session data available.

The First Complete Session Number is set to one.

The Last Complete Session Number indicates the number of the last complete session on the disc. The Last Complete Session Number shall be set to one for a single session disc or if the Drive does not support multi-session discs.

The ADR field gives the type of information encoded in the Q Sub-channel of the block where this TOC entry was found.

The CONTROL Field indicates the attributes of the track. First Track Number In Last Complete Session returns the first track number in the last complete session.

The Track Start Address contains the address of the first block with user information for the first track of the last session, as read from the Table of Contents.

6.25.3.3.2 MRW Deviations

If the disc is MRW formatted or in progress with MRW formatting, form 1 of the TOC shall report one session with one track. The track starting address shall be reported as shown in Table 472.

6.25.3.3.3 Non-CD Cases

When a non-CD media is present, Format 1 data shall be fabricated as shown in Table 479.

Table 479 — TOC Data Format 1: Data Returned for non-CD Discs

	Byte(s)	Field	Value
Header	0, 1	TOC Data Length	000Ah
	2	First Session Number	01h
	3	Last Session Number	01h
Track Descriptor	4	Reserved	00h
	5	ADR/CTL	17h: DVD+R and DVD+MRW 14h: all others
	6	First Track Number in Last Complete Session	01h
	7	Reserved	00h
	8 - 11	Track Start Address	LBA form = 000000h, MSF form = 00:02:00

6.25.3.4 Response Format 0010b: Raw TOC

6.25.3.4.1 General

None of the fields in the response data of Format 0010b are affected by the MSF bit in the CDB. The response data returned for Format 0010b is specified in Table 480.

Table 480 — READ TOC/PMA/ATIP response data (Format = 0010b)

Bit Byte	7	6	5	4	3	2	1	0
0	(MSB) TOC Data Length (LSB)							
1								
2	First Complete Session Number							
3	Last Complete Session Number							
TOC Track Descriptor(s)								
0	Session Number (Hex)							
1	ADR				CONTROL			
2	TNO							
3	POINT							
4	Min							
5	Sec							
6	Frame							
7	Zero							
8	PMIN							
9	PSEC							
10	PFRAME							

Multiple TOC Track Descriptors may be returned, but only one of each entry is reported.

For Format field of 0010b, the Drive shall return TOC data for Q Sub-channel modes 1 and 5 (except mode 5, point 1 through 40) in the Lead-in area.

The TOC Data Length specifies the length in bytes of the available TOC data. The TOC Data Length value does not include the TOC Data Length field itself. This value is not modified when the allocation length is insufficient to return all TOC data available.

The First Complete Session Number shall be set to one.

The Last Complete Session Number indicates the number of the last complete session on the disc. The Last Complete Session Number is set to one for a single session disc or if the Drive does not support multi-session discs.

The ADR field gives the type of information encoded in the Q Sub-channel of the block where this TOC entry was found.

The Control Field indicates the attributes of the track.

The ZERO field shall contain a value of zero.

Entries in bytes 2 through 7 of the descriptors (TNO, POINT, MIN, SEC, FRAME, ZERO) shall be converted to binary by the Drive when the media contains a value between 0 and 99bcd.

The returned TOC data of a multi-session disc is arranged in ascending order of the session number with duplicates removed. The TOC data within a session is arranged in the order of Q Sub-channel POINT field value of A0h – AFh, Track Numbers, B0h, BFh. Only recorded Points shall be returned.

The TOC Track Descriptor format in the Lead-in area of the TOC is described in Table 481.

Table 481 — TOC Track Descriptor Format, Q Sub-channel

CTRL	ADR	TNO	POINT	MIN	SEC	FRAME	ZERO	PMIN	PSEC	PFRAME
4 or 6	1	00h	01h-63h	ATIME (Absolute time)			00h	Start position of track		
4 or 6	1	00h	A0h	ATIME (Absolute time)			00h	First Track Number	Disc Type	00h
4 or 6	1	00h	A1h	ATIME (Absolute time)			00h	Last Track Number	00h	00h
4 or 6	1	00h	A2h	ATIME (Absolute time)			00h	Start position of Lead-out		
4 or 6	5	00h	B0h	Start time of next possible program in the Recordable Area of the disc			# of pointers in Mode 5	Maximum start time of outer-most Lead-out area in the Recordable Area of the disc		
4 or 6	5	00h	B1h	00h	00h	00h	00h	# of skip interval Pointers (N<=40)	# of skip Track Pointers (N<=21)	00h
4 or 6	5	00h	B2h-B4h	Skip #	Skip #	Skip #	Skip #	Skip #	Skip #	Skip #
4 or 6	5	00h	01h-40h	Ending time for the interval that should be skipped			Reserved	Start time for interval that should be skipped on playback		
4 or 6	5	00h	C0h	optimum recording power	Reserved	Reserved	Reserved	Start time of the first Lead-in Area of the disc		
4 or 6	5	00h	C1h	Copy of information from A1 point in ATIP.						

If the disc is MRW formatted or in progress with MRW formatting, form 2 of the TOC shall be constructed to contain the values expected when formatting has completed.

All of the TOC Track Descriptors (Table 481) are further defined in 4.2.3.7.

The POINT field (Table 482) defined various types of information within the lead-in TOC area.

Table 482 — POINT Field

ADR	POINT Field	Description
1	01-63h	Track number references
1	A0h	First Track number in the program area
1	A1h	Last Track number in the program area
1	A2h	Start location of the Lead-out area
5	01-40h	Skip Interval Pointers
5	B0h	Used to Identify a Multi-session Disc (Photo CD) Contains start time of next possible program area
5	B1h	Number of skip interval pointers & Skip track assignments
5	01-40h	Skip Interval Pointers
5	B2-B4h	Skip Track Assignment Pointers
5	C0h	Start time of first Lead-in area of disc (This only exists in the first Lead-in area)
5	C1h	Copy of information from additional area 1 in ATIP.

The Disc Type field (see Table 483) indicates the type of disc inserted.

Table 483 — Disc Type Byte Format

Value	Description
00h	CD-DA or CD Data with first track in Mode 1
10h	CD-I disc
20h	CD data XA disc with first track in Mode 2

6.25.3.4.2 CD-MRW Deviations

If the disc is MRW formatted or in progress with MRW formatting form 2 of the TOC, PMA, shall be constructed to contain the values expected when formatting has completed.

6.25.3.4.3 Non-CD Discs

No fabrication for non-CD media is defined for form 0010b. If the Host requests a TOC/PMA/ATIP of this form when a non-CD disc is present, the Drive shall terminate the command with CHECK CONDITION status and set sense bytes SK/ASC/ASCQ to ILLEGAL REQUEST/INVALID FIELD IN CDB.

6.25.3.5 Response Format 0011b: PMA

6.25.3.5.1 General

None of the fields in the response data of Format 0011b are affected by the MSF bit in the CDB. The response data returned for Format 0011b is specified in Table 484.

Table 484 — READ TOC/PMA/ATIP response data (Format = 0011b)

Bit Byte	7	6	5	4	3	2	1	0
0	(MSB) PMA Data Length							
1	(LSB)							
2	Reserved							
3	Reserved							
PMA Descriptor(s)								
0	Reserved							
1	ADR				CONTROL			
2	TNO							
3	POINT							
4	Min							
5	Sec							
6	Frame							
7	Zero							
8	PMIN							
9	PSEC							
10	PFRAME							

Multiple PMA Descriptors may be returned.

The returned PMA descriptors are arranged in the order found in the PMA, with duplicates removed.

The PMA Data Length indicates the length in bytes of the available PMA data. The PMA Data Length value does not include the PMA Data Length field itself. This value is not modified when the allocation length is insufficient to return all PMA data available. This value is set to 2 plus eleven times the number of descriptors read.

The ZERO field shall contain a value of zero.

Entries in bytes 2 through 10 of the descriptors, (TNO, POINT, MIN, SEC, FRAME, Zero), shall be converted to binary by the Drive if the media contains a value between 0 and 99bcd. (See 4.2.3.10.3)

6.25.3.5.2 CD-MRW Deviations

If the disc is MRW formatted or in progress with MRW formatting form 3 of the TOC, the PMA, shall be constructed to contain the values expected when formatting has completed.

6.25.3.5.3 Non-CD Discs

No fabrication for non-CD media is defined for form 0010b. If the Host requests a TOC/PMA/ATIP of this form when a non-CD disc is present, the Drive shall terminate the command with CHECK CONDITION status and set sense bytes SK/ASC/ASCQ to ILLEGAL REQUEST/INVALID FIELD IN CDB.

6.25.3.6 Response Format 0100b: ATIP

6.25.3.6.1 General

The MSF bit in the CDB affects no fields in the response data of Format 0100b. The response data returned for Format 0100b is specified in Table 485.

Table 485 — READ TOC/PMA/ATIP response data (Format = 0100b)

Bit Byte	7	6	5	4	3	2	1	0
0	(MSB) ATIP Data Length							
1	(LSB)							
2	Reserved							
3	Reserved							
ATIP Descriptor								
Special Information 1								
0	Indicative Target Writing Power				Reserved	Reference Speed		
1	0	URU	Reserved					
2	1	Disc Type	Disc Sub-Type			A1 Valid	A2 Valid	A3 Valid
3	Reserved							
Special Information 2								
4	ATIP Start Time of Lead-in (Min)							
5	ATIP Start Time of Lead-in (Sec)							
6	ATIP Start Time of Lead-in (Frame)							
7	Reserved							
Special Information 3								
8	ATIP Last Possible Start Time of Lead-out (Min)							
9	ATIP Last Possible Start Time of Lead-out (Sec)							
10	ATIP Last Possible Start Time of Lead-out (Frame)							
11	Reserved							
Additional Information 1								
12 – 14	A1 Values							
15	Reserved							
Additional Information 2								
16-18	A2 Values							
19	Reserved							
Additional Information 3								
20-22	A3 Values							
23	RESERVED							
24-26	S4 Values							
27	Reserved							

ATIP Data Length specifies the number of bytes to be transferred in response to the command. The ATIP Data Length value does not include the data length field itself. This value is not modified when the Allocation Length is insufficient to return all of the ATIP data available.

6.25.3.6.2 ATIP Descriptor for CD-R/RW Media

6.25.3.6.2.1 General

For specific field values and meanings, see [CD-Ref6], [CD-Ref7], [CD-Ref8] and [CD-Ref9].

6.25.3.6.2.2 Special Information 1

Indicative Device Writing Power is encoded information indicating the media's recommended initial laser power setting.

Reference Speed – is encoded information indicating the recommended write speed for the media.

The Unrestricted Use Disc (URU) bit is derived from Application Code. When Application Code indicates that the mounted disc is either for unrestricted use or general purpose, the Unrestricted Use bit is set to one. When the URU flag is zero, the mounted disc is defined for restricted use. In order to record data to the mounted disc the appropriate Host Application code shall be set through the Write Parameters Mode Page.

When Disc Type is zero, the media is CD-R. When Disc Type is one, the media is CD-RW.

Disc Sub-Type specifies one of 8 possible CD-RW sub-types of the Disc Type. CD-R has no sub-types, so this field is zeros. The sub-type typically identifies media sensitivity. When the media is made for higher speed applications, the media is more sensitive. Some higher speed write sub-type media may be damaged if recorded at power levels used for lower speed sub-types. The CD-RW Media Write Support Feature (5.3.27) identifies the Drive's write support for all CD-RW sub-types.

A1 – when set to one, indicates that the A1 Values field is valid. Otherwise, the A1 Values field is invalid.

A2 – when set to one, indicates that the A2 Values field is valid. Otherwise, the A2 Values field is invalid.

A3 – when set to one, indicates that the A3 Values field is valid. Otherwise, the A3 Values field is invalid.

6.25.3.6.2.3 Special Information 2: Start Time of Lead-in

The Start Time of the Lead-in identifies the ATIP time of where the disc lead-in starts.

6.25.3.6.2.4 Special Information 3: Last Possible Start Time of Lead-out

For all CD-RW and CD-R conforming to Orange Book part II, Special Information 3 contains the MSF address of the maximum start point for the final lead-out. The Last Possible Start Time of Lead-out shall not be greater than 79:59:74 MSF. It is recommended that this boundary not be violated by extending the program area past the Last Possible Start Time of Lead-out.

A single session disc requires a final lead-out of 90 seconds, while a multi-session disc requires a final lead-out of 30 seconds. This suggests that the program area may violate the Last Possible Start Time of Lead-out by as much as 60 seconds when the disc is multi-session.

6.25.3.6.2.5 Special Information 3: Start Time of Additional Capacity

High capacity CD-R (See [CD-Ref10]) defines Special Information 3 as the Start Time for Additional Capacity. The additional capacity includes space for additional program area and the final lead-out. A field in Additional Information 1 defines the additional number of minutes. Thus:

Start Time of Additional Capacity as a PSN +

Capacity Extension as a number of sectors – 1 =

PSN of Last possible lead-out sector.

6.25.3.6.2.6 Additional Information 1

Additional Information 1 contains fields identify additional write strategy recording parameters.

For High capacity CD-R, Additional Information 1 also contains a Capacity Extension field. This field is coded for an extension in minutes. See 6.25.3.6.2.5, above.

6.25.3.6.3 Non-CD Discs

No fabrication for non-CD media is defined for form 0010b. If the Host requests a TOC/PMA/ATIP of this form when a non-CD disc is present, the Drive shall terminate the command with CHECK CONDITION status and set sense bytes SK/ASC/ASCQ to ILLEGAL REQUEST/INVALID FIELD IN CDB.

6.25.3.7 Response Format 0101b: CD-TEXT

6.25.3.7.1 CD Discs

None of the fields in the response data of Format 0101b (Table 486) are affected by the MSF bit in the CDB.

Table 486 — READ TOC/PMA/ATIP response data (With Format Field = 0101b)

Bit Byte	7	6	5	4	3	2	1	0
0	(MSB) CD-TEXT Data Length (LSB)							
1								
2	Reserved							
3	Reserved							
CD-TEXT Descriptor(s)								
0 : 17	CD-TEXT Data							

CD-TEXT Data Length specifies the number of bytes to be transferred in response to the command. The CD-TEXT Data Length value does not include the data length field itself. This value is not modified when the allocation length is insufficient to return all of the CD-TEXT data available. This length is variable depends on the number of recording Pack Data.

CD-TEXT Information Descriptor(s) provides Pack Data available in the lead-in area of the disc. Each Pack Data consists of 18 bytes of CD-TEXT information. If a Pack Data is recorded repeatedly on the disc, the device should return it only once.

The detail of Pack Data and CD-TEXT information is described in System Description Compact Disc Digital Audio Addendum: CD-TEXT.

6.25.3.7.2 Non-CD Discs

No fabrication for non-CD media is defined for form 0010b. If the Host requests a TOC/PMA/ATIP of this form when a non-CD disc is present, the Drive shall terminate the command with CHECK CONDITION status and set sense bytes SK/ASC/ASCQ to ILLEGAL REQUEST/INVALID FIELD IN CDB.

6.25.4 Timeouts

The READ TOC/PMA/ATIP command belongs to timeout group 1. If the command is terminated with CHECK CONDITION status due to a timeout, sense bytes SK/ASC/ASCQ shall be set to UNIT ATTENTION/INSUFFICIENT TIME FOR OPERATION.

6.25.5 Error Reporting

Recommended error reporting for the READ TOC/PMA/ATIP command is defined in Table 487.

Table 487 — Recommended errors for READ TOC/PMA/ATIP Command

Error	Reference
Unit Attention conditions	Table F.1
CDB or parameter list validation errors	Table F.2
Readiness errors	Table F.3
General media access errors	Table F.5
Read errors	Table F.6
Hardware failures	Table F.8

6.26 READ TRACK INFORMATION Command

6.26.1 Introduction

The READ TRACK INFORMATION Command provides information about a logical track. Logical track is a generic term used to reference logical subdivisions of an optical media. Logical track refers to track on CD media, RZone on DVD-R/-RW media and fragment on DVD+R media. When the currently mounted media has no logical track structure, the entire media shall be considered a single logical track.

Table 488 shows the Features associated with the READ TRACK INFORMATION command.

Table 488 — Features Associated with the READ TRACK INFORMATION Command

Feature Number	Feature Name	Command Requirement
001Dh	Multi-Read	Mandatory
0021h	Incremental Streaming Writable	Mandatory
0026h	Restricted Overwrite	Mandatory
0027h	CD-RW CAV Write	Mandatory
002Bh	DVD+R	Mandatory
002Ch	Rigid Restricted Overwrite	Mandatory
002Dh	CD Track At Once	Mandatory
002Eh	CD Mastering (both SAO and RAW)	Mandatory
002Fh	DVD-R/-RW Write	Mandatory
0033h	Layer Jump Recording	Mandatory
0051h	HD DVD-R Write	Mandatory

6.26.2 The CDB and Its Parameters

6.26.2.1 The CDB

The READ TRACK INFORMATION CDB is shown in Table 489.

Table 489 — READ TRACK INFORMATION CDB

Bit	7	6	5	4	3	2	1	0
0	Operation Code (52h)							
1	Reserved					Open	Address/Number Type	
2	(MSB) Logical Block Address/ Track/Session Number (LSB)							
3								
4								
5								
6								
7	(MSB) Allocation Length (LSB)							
8								
9	Control Byte							

6.26.2.2 Open

If Open is set to zero, the addressed Logical Track shall be located according to the Logical Block Address/Track/Session Number field. If Open is set to one, the Drive shall locate the first open Logical Track

with Logical Track number that is greater than or equal to the Logical Track specified by the Logical Block Address/Track/Session Number field.

6.26.2.3 Address/Number Type

The Address/Number Type field in byte 1 is used to specify the contents of the Logical Block Address/Track/Session Number field, bytes 2 through 5 of the CDB. The Description of these parameters is shown in Table 490.

6.26.2.4 Logical Block Address/Track/Session Number Fields

The Logical Block Address/Track/Session Number field either directly or indirectly specifies the logical track for which the Drive is to provide track information. See Table 490.

Table 490 — Addressed Track (T_A) According to LBA/Track/Session Number Field

Address/Number Type field	Logical Block Address/Track/Session Number	Description
00b	Logical Block Address (LBA)	MAX = Last Possible Lead-out Start Address as returned by the READ DISC INFORMATION command. If $LBA \geq MAX$, the command shall be terminated with CHECK CONDITION status and sense bytes SK/ASC/ASCQ shall be set to ILLEGAL REQUEST/LOGICAL BLOCK ADDRESS OUT OF RANGE. Otherwise, LBA lies within some logical track, T_A .
01b	Logical track number (LTN)	T_M = Last Track Number in the Last Session as returned by the READ DISC INFORMATION command. If $LTN > T_M$, the command shall be terminated with CHECK CONDITION status and sense bytes SK/ASC/ASCQ shall be set to ILLEGAL REQUEST/INVALID FIELD IN CDB. Otherwise, $T_A = LTN$. If LTN is zero and the currently mounted disc is not CD, the command shall be terminated with CHECK CONDITION status and sense bytes SK/ASC/ASCQ shall be set to ILLEGAL REQUEST/INVALID FIELD IN CDB.
10b	Session Number (S_N)	S_M is the Number of Sessions as returned by the READ DISC INFORMATION command. If $S_N > S_M$, the command shall be terminated with CHECK CONDITION status and sense bytes SK/ASC/ASCQ shall be set to ILLEGAL REQUEST/INVALID FIELD IN CDB. Otherwise the $T_A =$ the first logical track in session S_N .
11b	Reserved	

6.26.2.5 Determining the Specific Logical Track

For multi-track discs, there are potentially 3 logical track numbers to be determined: T , T_A , and T_O .

1. T is the Logical Track number for which Track Information shall be returned.
2. The Address/Number Type and the Logical Block Address/Track/Session Number fields specify an addressed logical track, T_A that is valid according to Table 490.
3. T_O is the smallest track number such that T_O is open and $T_A \leq T_O$. If the disc contains no open tracks, then T_O shall be set to FFFFh.

If Open is set to zero, then $T = T_A$. If Open is set to one, then T shall be set to T_O .

If it is not possible for the currently mounted disc to have open tracks, and Open is set to one, then the command shall be terminated with CHECK CONDITION status and sense bytes SK/ASC/ASCQ shall be set to ILLEGAL REQUEST/INVALID FIELD IN CDB.

If Open is set to one and the track number is determined to be FFFFh, the Drive shall set the following fields to all Fh:

- a. the Session/Border Number (LSB) field
- b. the Session/Border Number (MSB) field
- c. the Track/RZone Number (LSB) field

- d. the Track/RZone Number (MSB) field

And all the other fields, except the Data Length field, shall be set to 00h in the Track/RZone Information Block.

6.26.2.6 Allocation Length

The number of Track Information Block bytes returned is limited by the Allocation Length parameter of the CDB. An Allocation Length of zero is not an error.

6.26.3 Command Processing

6.26.3.1 Overview

The Drive shall collect the information requested by the Host into a Track Information Block structure, and transfer to the Host, restricted by Allocation Length.

The READ TRACK INFORMATION command shall provide minimal information for a disc with Unrecordable status: Track Number, Session Number, Track Mode, Data Mode, Track Start Address.

The format and content of the Track Information Block is shown in Table 491.

Table 491 — Track Information Block

Bit Byte	7	6	5	4	3	2	1	0
0	(MSB) Data Length (LSB)							
1								
2	Logical Track Number (Least Significant Byte)							
3	Session Number (Least Significant Byte)							
4	Reserved							
5	LJRS		Damage	Copy	Track Mode			
6	RT	Blank	Packet/Inc	FP	Data Mode			
7	Reserved						LRA_V	NWA_V
8	(MSB) Logical Track Start Address (LSB)							
...								
11								
12	(MSB) Next Writable Address (LSB)							
13								
...								
16	(MSB) Free Blocks (LSB)							
...								
19								
20	(MSB) Fixed Packet Size/ Blocking Factor (LSB)							
...								
23								
24	(MSB) Logical Track Size (LSB)							
...								
27								
28	(MSB) Last Recorded Address (LSB)							
...								
31								
32	Logical Track Number (Most Significant Byte)							
33	Session Number (Most Significant Byte)							
34	Reserved							
35	Reserved							
36	(MSB) Read Compatibility LBA (LSB)							
...								
39								
40	(MSB) Next Layer Jump Address (LSB)							
...								
43								
44	(MSB) Last Layer Jump Address (LSB)							
...								
47								

6.26.3.2 Data Length

The Data Length field specifies the length, in bytes, of the available track information data. The Data Length value does not include the data length field itself. The Data Length is not modified when the allocation length is insufficient to return all of the response data available.

6.26.3.3 Logical Track Number

Logical Track Number is contained within bytes 2 and 32 of this structure. For media not containing logical tracks (track, RZone, Fragment, or SRR), this field shall contain the value 1.

If the Logical Track number is set to zero, the disc is a CD and the contents of Track Information Block shall be returned for the lead-in area. In this case, the Track Start Address field is the start address of the lead-in area.

6.26.3.4 Session Number

Session Number is the number of the session containing this track, or a value of 1 for media not containing sessions that contain this track.

6.26.3.5 Copy bit

For CD, the Copy bit indicates that this track is a second or higher generation copy. For other media, this bit shall be set to zero.

6.26.3.6 LJRS

The Layer Jump Recording Status (LJRS) field defines the current Layer Jump Recording status for the currently mounted medium. The meaning of the possible values for LJRS are shown in Table 492.

Table 492 — LJRS Field Definition

Value	Recording Mode		Definition
00b	DAO or Incremental		The disc is blank and Layer Jump Recording is not supported for the currently medium, or The disc is blank and the Write Type field in the Write Parameters Mode Page is set to other than Layer Jump, or The disc is not in Layer Jump recording mode. i.e. The recording mode is either DAO or Incremental recording.
01b	Layer Jump	Unspecified	The disc is blank and Write Type field is set to Layer Jump, or The disc is in Layer Jump recording mode. The RZone has the Complete state, Reserved state or Invisible state. For the Invisible RZone, neither Manual Layer Jump Address nor Jump Interval size for Regular Interval Layer Jump recording is specified.
10b		Manual	The disc is in Layer Jump recording mode. The RZone has the Invisible/Incomplete state and is in Manual Layer Jump recording mode.
11b		Regular Interval	The disc is in Layer Jump recording mode. The RZone has the Invisible/Incomplete state and is in Regular Interval Layer Jump recording mode. The Jump Interval size field of the READ DISC STRUCTURE command with Format Code=22h shall report the Jump Interval size in blocks.

When LJRS is not zero, the Next Layer Jump Address field and the Last Layer Jump Address fields shall be present after the Read Compatibility LBA field in the Track Information Block. The Packet/Inc bit shall be set to one, and the FP bit shall be set to zero.

6.26.3.7 Damage Bit

The Damage bit, when set to one, and the NWA_V is set to zero; the track shall be considered “not closed due to an incomplete write”. The Drive may attempt an automatic repair when the CLOSE TRACK/SESSION command is issued. Further incremental writing in this track is not possible. The Damage bit, when set to one, and the NWA_V is set to one, indicates a Track that may be recorded further in an incremental manner. The Drive shall attempt an automatic repair when the next command that requires writing to the Track is issued. If the repair is successful, the Damage bit shall be set to zero. Prior to the start of the repair, the NWA field shall contain the address of the Next Writable Sector assuming a successful repair.

6.26.3.8 Track Mode

Track mode was originally defined for CD media and is recorded on the media. For other media, track mode is fabricated from the media characteristics. Table 493 shows the values for different media types.

Table 493 — Track Mode Definition

Media/Format	Track Mode
CD-ROM/-R/-RW	Track Mode for CD is the control nibble as defined for mode 1 Q Sub-channel for this track. See Table 17.
DVD+MRW, DVD+R	07h, indicating: data, incremental recording, copy permitted
All other media	04h, indicating: data, uninterrupted recording, no copy permissions

6.26.3.9 Track Status: RT, Blank, Packet, and FP Bits

The meaning of the RT (Reserved Track) bit is defined in Table 494.

Table 494 — RT Bit Definition

Media Type	RT = 0	RT = 1
CD-ROM, DVD-ROM, HD DVD-ROM, BD-ROM, DVD-RAM, DVD+RW, HD DVD-RAM, BD-RE	Default	—
CD-R/-RW	The Track is the invisible/incomplete track	A PMA entry is written identifying the start and end addresses of the track
DVD-R/-RW, HD DVD-R	The RZone is Complete, Invisible or Incomplete	The RZone is reserved. It may be either empty or partially recorded.
DVD+R	The Logical Track is the invisible/incomplete fragment.	The bounds of the fragment are defined within the Disc/Session Identification Zone.
BD-R	The Logical Track is the invisible/incomplete SRR.	The SRR is in the list of SRRs, it is not the last SRR in the list.

The definition of the Blank bit is given in Table 495.

Table 495 — Blank Bit Definition

Media Type	Blank = 0	Blank = 1
CD-R/RW	Minimally, the track pre-gap is written.	All sectors within the track and its pre-gap are blank.
DVD-R/-RW, DVD+R, HD DVD-R, BD-R	Some non-zero number of writable units within the Logical Tracks is written.	All writable units within the Logical Track are blank.
DVD-RAM, HD DVD-RAM, BD-RE	Blank has no meaning for this media. The Blank bit shall always be zero for this media.	
DVD+RW	The Disc Status in the Disc Information Block shows that the disc is not blank.	The Disc Status in the Disc Information Block shows that the entire disc is blank.

The definition of the Packet/Inc bit is given in Table 496.

Table 496 — Packet/Inc Bit Definition

Media Type	Packet/Inc = 0	Packet/Inc = 1
CD-R/RW	Based upon existing track format and Write Parameters Mode Page	
DVD-R/-RW	Based upon existing RZone format and Write Parameters Mode Page	
DVD-RAM, DVD+R, DVD+RW, HD DVD-RAM, HD DVD-R, BD-RE	—	Always

The definition of the FP (Fixed Packet) bit is given in Table 497.

Table 497 — FP bit Definition

Media Type	FP = 0	FP = 1
CD-R/RW	Based upon existing track format and Write Parameters Mode Page	
DVD-R/-RW, HD DVD-R	Based upon existing RZone format and Write Parameters Mode Page	
DVD-RAM, DVD+R, DVD+RW, HD DVD-RAM, BD-R, BD-RE	—	Always

When writing CD and DVD-R/-RW, certain parameters may be set via the Write Parameters Page. The state of the track determines what parameters shall be set and that parameters in the mode page shall match. Required Write Parameters are defined in Table 498.

Table 498 — Write Parameter Restrictions due to Track State

RT	Blank	Packet	CD Write Parameter Restrictions	DVD-R/-RW Write Parameter Restrictions
0	0	0	Unable to write to stamped disc, or during track at once on invisible track, or writing session at once mode	Unable to write to stamped disc, or writing disc-at-once, unable to write to complete disc.
0	0	1	Write type is set to packet; all parameters common to READ TRACK I and the Write Parameters Page shall match.	Write type is set to incremental; all parameters common to READ TRACK I and the Write Parameters Page shall match
0	1	0	Write type may be set to packet or TAO. All other parameters shall be changeable. If this track is the first track of a Session, then Session at Once is allowed.	Write type is set to disc-at-once: Invisible Track of disc-at-once, empty. Unable to start disc-at-once recording in this state. A Track shall be reserved prior to start of disc-at-once recording. All parameters common to READ TRACK I and the Write Parameters Page shall match
0	1	1	Invalid State	Write type is set to incremental; Invisible track for incremental recording, the Track is writable. All parameters common to READ TRACK I and the Write Parameters Page shall match
1	0	0	Unable to write to recorded track or during track at once on reserved Track.	Unable to write to disc during disc at once on reserved Track.
1	0	1	Write type is set to packet; all parameters common to READ TRACK INFO and the Write Parameters Page shall match.	Write type is set to incremental; Partially recorded reserved Track, the Track is writable. All parameters common to READ TRACK I and the Write Parameters Page shall match
1	1	0	Write type is set to TAO. Track mode set to same as READ TRACK INFO. Copy bit may be set only if copyright bit in track mode is clear. All other common parameters shall match.	Write type is set to disc-at-once; Empty reserved Track for disc-at-once. All parameters common to READ TRACK I and the Write Parameters Page shall match
1	1	1	Write type is set to Packet. Track mode set to same as READ TRACK INFO. Copy bit may be set only if copyright bit in track mode is clear. FP and packet size are changeable. All other common parameters shall match.	Write type is set to incremental; Empty reserved Track, the Track is writable. All parameters common to READ TRACK I and the Write Parameters Page shall match

Table 499 shows the consequences of the Logical Track status bits: RT, Blank, Packet/Inc, and FP.

Table 499 — Track Status Indications

RT	Blank	Packet/ Inc	FP	DVD-R/-RW		CD	
				Write Method	Track Status	Write Method	Track Status
0	0	0	-	- DAO	Complete	Uninterrupted/ TAO/SAO	Complete/During TAO/SAO
0	0	1	0	Incremental	Incomplete or Complete ¹	Variable	Incomplete
0	0	1	1	- Restricted Overwrite	Complete or Incomplete ²	Fixed	Incomplete
0	1	0	-	DAO	Invisible	TAO/Variable/ Fixed ³	Invisible
0	1	1	0	Incremental	Invisible	-	(invalid)
0	1	1	1	- Restricted Overwrite	Invisible	-	(invalid)
1	0	0	-	DAO	during DAO	TAO	Complete/During TAO
1	0	1	0	Incremental	Partially Recorded Reserved	Variable	Complete/ Partially Recorded Reserve
1	0	1	1	-	(invalid)	Fixed	Complete/ Partially Recorded Reserve
1	1	0	-	DAO	Empty Reserved Before starting writing	TAO	Empty Reserved
1	1	1	0	Incremental	Empty Reserved	Variable/Fixed	Empty Reserved
1	1	1	1	-	(invalid)	-	(invalid)

¹ If Free Blocks field is 0, the track is in the Complete state. Otherwise, the track is Incomplete state.
² In the case of a track that is in the intermediate state session, the track is considered as in the Incomplete state.
³ In case last Session is empty, SAO is also valid.

6.26.3.10 Data Mode

Data Mode field defines the track content. Data Mode for CD is defined in Table 500.

Table 500 — CD Data Modes

Value	Definition
1	Mode 1 (ISO/IEC 10149)
2	Mode 2 (ISO/IEC 10149 or CD-ROM XA)
Fh	Data Block Type unknown (no track descriptor block)
0, 3 – Eh	Reserved

For all other media types, Data Mode shall be set to 1.

6.26.3.11 NWA_V

If NWA_V is zero, then the next writable address field is not valid. Otherwise the next writable address field is valid. NWA_V shall be set to zero if the Track is not writable for any reason. If the disc is MRW formatted or in progress with MRW formatting, then NWA_V shall be set to zero. If the disc is DVD+RW or DVD+RW DL basic formatted or in progress with DVD+RW or DVD+RW DL basic formatting, then NWA_V shall be set to zero.

6.26.3.12 LRA_V

If LRA_V is zero, then the Last Recorded Address field is not valid. Otherwise, the Last Recorded Address field is valid. The LRA_V bit shall be set to zero if the Track has damage for any reason and is repaired automatically.

6.26.3.13 Track Start Address

Track Start Address contains the address of the first block with user information for that Logical Track.

6.26.3.14 Next Writable Address

The Next Writable Address, if valid, is the LBA of the next writable user block in the Track specified by the LBA/Track Number field in the CDB. For CD media, Next Writable Address shall be associated with the RT, Blank, Packet and FP bits as defined in Table 501. If the write type is Raw, the Next Writable Address may be a negative number as required to point to the start of the first Lead-in. When streaming in any write type, the Next Writable Address shall be the next user data block the Drive expects to receive if no under-run occurs.

Table 501 — Next Writable Address Definition

RT	Blank	Packet	FP	NWA_V	Definition
0	0	0	-	0 ⁴	LBA that shall be specified by next write command ²
0	0	1	0	1 ¹	LBA that shall be specified by next write command ²
0	0	1	1	1 ¹	LBA that shall be specified by next write command ^{2,3}
0	1	0	0	1	LBA of the first data block after pre-gap ⁵
0	1	1	x	-	-
1	0	0	-	0 ⁴	LBA that shall be specified by next write command ²
1	0	1	0	1 ¹	LBA that shall be specified by next write command ²
1	0	1	1	1 ¹	LBA that shall be specified by next write command ^{2,3}
1	1	0	-	1	LBA of the first data block after pre-gap
1	1	1	0	1	LBA of the first data block after pre-gap
1	1	1	1	-	-

¹When "Free Blocks" is 0 (data full), NWA_V is 0.

²The NWA takes account of data blocks in buffer that have not yet been written to media. If the Drive is able to write the data of next write command without interrupting of current data streaming (no underrun condition), the NWA is contiguous to the last address data in buffer. If WCE in Mode Cache Page is zero, the NWA takes account of Link Blocks.

³On CD, NWA calculations follow the Addressing Method-2.

⁴During TAO (SAO), NWA_V is 1.

⁵In the case of SAO the NWA is the first block after the Lead-in for the first track of session.

6.26.3.15 Free Blocks

The Free Blocks field represents the maximum number of user data blocks available for recording in the Logical Track. The value returned is media type and format dependent.

6.26.3.15.1 CD

For CD media, this field shall be computed as follows: First, the Available Track Space (ATS) shall be computed. In the cases that follow *StartTimeofLastPossibleLead-out* is as defined in 6.22.3.18.

For the invisible track, $ATS = (StartTimeofLastPossibleLead-out) - NWA + 5$.

For a reserved track, $ATS = (PMAStopTime) - NWA + 5$.

For the invisible/incomplete track, $ATS = (StartTimeofLastPossibleLead-out) - NWA + 4$.

For a reserved track, $ATS = (PMAStopTime) - NWA + 4$.

If the track is reserved for fixed packets, or written with fixed packets, or is the invisible track and the Write Parameters Page specifies fixed packets,

$$FreeBlocks = IP \left[\frac{ATS}{PacketSize + 7} \right] \cdot PacketSize.$$

Otherwise, $FreeBlocks = ATS - 7$.

The *StartTimeofLastPossibleLead-out* is the last possible location of the link block at the start of the Lead-out. If a disc is fully recorded, the PMA entry for the last track is equal to the *StartTimeofLastPossibleLead-out*.

The Drive for reading and writing translates addressing within fixed packet written tracks. The NWA shall also reflect this translation:

$$NWA_{Method2} = NWA_{Method1} - 7 \cdot IP \left[\frac{NWA_{Method1} - TrackStartAddress}{PacketSize + 7} \right]$$

Method 1 is the physical address.

Method 2 is used on fixed packet written tracks to hide the link areas from the Host. The TrackStartAddress is always a physical address, even if prior tracks are recorded with Method 2. IP[...] is the integer part of the value.

6.26.3.15.2 Formatted Rewritable Media: DVD-RAM, DVD+RW, HD DVD-RAM, BD-RE

Free Blocks is associated with incremental recording. When Formattable, rewritable media is present, Free Blocks shall be set to zero.

6.26.3.15.3 DVD-R/-RW, DVD-R DL

With these media type, the actual length of the Logical Track is known. When NWA_V is set to zero, Free Blocks shall be set to zero.

For DVD-R/-RW, this field value shall exclude the number of BSGA/LLA blocks that are located on the RZone boundary. In Layer Jump recording mode on DVD-R Dual Layer media, the number of BSGA/LLA blocks that are located on LJB boundary shall also be excluded to return actual available user data blocks in the RZone.

6.26.3.15.4 DVD+R, DVD+R DL, HD DVD-R, BD-R

With these media types, the actual length of the Logical Track is known. When NWA_V is set to zero, Free Blocks shall be set to zero. The number of free blocks in the Logical Track are number of blocks from the NWA until the end of the track: Logical Track Size – (Track Start Address – NWA).

6.26.3.16 Fixed Packet Size

For CD, the Fixed Packet Size is valid only when the Packet and the FP bits are both set to one.

For DVD media, this field has a value of 16.

For HD DVD media, this field has a value of 32.

For BD media, this field has a value of 32.

6.26.3.17 Track Size

6.26.3.17.1 General

Track Size is the number of user data blocks in the logical track.

6.26.3.17.2 CD Track Size

For CD the track size shall be computed as follows:

First, compute the Complete Track Size (CTS).

For an incomplete track: $CTS = (StartTimeofLastPossibleLead-out) - PMATrackStart + 5$.

For a reserved track: $CTS = (PMAStopTime) - PMAStartTime + 5$.

For CD media, the Track Size number may not be exact for the tracks that do not have a PMA entry. The track size, of tracks that do not have PMA entries, is calculated as follows:

TrackSize of track $n = (start\ of\ track\ n+1) - (start\ of\ track\ n)$, $n+1$ is the Lead Out if n is the last track recorded in the TOC.

The Track Size from this calculation may include blocks from the following track and these blocks may not be readable.

If the disc is MRW formatted or in progress with MRW formatting, Track Size shall be reported according to the LBA Space selected in the MRW Mode Page. The Track Size of a MRW disc is simply the sum of all the DA sizes given in user sectors.

6.26.3.17.3 DVD-ROM Track Size

A DVD-ROM disc has exactly one logical track, track 1. The logical track size is calculated using information collected from the Control Data Zone:

$$\text{Logical Track Size} = \text{End Physical Sector Number of Data Area} - \text{Starting Physical Sector Number of Data Area} + 1.$$

6.26.3.17.4 DVD-RAM Track Size

A DVD-RAM disc has exactly one logical track, track 1. The logical track size is calculated using information collected from the Control Data Zone:

Logical Track Size = End Physical Sector Number of Data Area - Starting Physical Sector Number of Data Area + 1.

6.26.3.17.5 DVD-R, DVD-R DL when LJRS = 00b, and DVD-RW Track Size

For DVD-R/-RW, the Track Size field reports the number of sectors in the specified logical track (RZone) as follows:

If the RZone is complete, this field reports the number of sectors in the specified RZone including all padded sectors except the last 1 or 16 sectors of the RZone.

The RZone size is calculated according to the following rule:

First, compute the following bit mask operation to get Linking Status of RZone (LSR):

$LSR = NextRZoneStartAddress \&\& OFh$ (“&&” means the logical AND operation)

where the *NextRZoneStartAddress* is the start address of the RZone that is located immediately after the complete RZone to be calculated.

If the complete RZone to be calculated is the last RZone, the *NextRZoneStartAddress* is the start address of the last Border-out.

If the $LSR = 0$,

$RZoneSize = NextRZoneStartAddress - RZoneStartAddress - 16$ sectors;

Otherwise,

$RZoneSize = NextRZoneStartAddress - RZoneStartAddress - 1$ sectors; where the *RZoneStartAddress* is the start address of the complete RZone to be calculated.

For an incomplete RZone or invisible RZone, this field reports the number of sectors in the specified RZone including unrecorded sectors except the sectors to be used for the Border-out or truncated Border-out and its BSGA (16 sectors). The end address of the invisible/incomplete RZone is specified by the Outer limit of Data Recordable area field or the End PSN of Data Area field in Data Area Allocation field of Control Data Zone.

The RZone size is calculated as follows:

$RZoneSize = EndPSNOfRZone - RZoneStartAddress - NumberOfSectorsInBorderOut - 16$ sectors, where the *EndPSNOfRZone* is the end address of the invisible/incomplete RZone.

The *NumberOfSectorsInBorderOut* is the number of sectors to be recorded as Border-out or truncated Border-out just before the Lead-out.

For a reserved RZone, this field reports the number of sectors in the specified RZone including all unrecorded sectors except the last 16 sectors of the RZone to be used as a BSGA.

The RZone size is calculated as follows:

$RZoneSize = NextRZoneStartAddress - RZoneStartAddress - 16$ sectors

6.26.3.17.6 DVD-R DL when LJRS ≠ 00b Track Size

The Track/RZone Size / RZone End Address field reports the LBA of the last sector that is available to record user data in the specified RZone.

6.26.3.17.7 DVD+RW and DVD+RW DL Track Size

A DVD+RW disc has exactly one logical track, track 1. The logical track size is calculated using information collected from the disc ADIP:

Logical Track Size = End Physical Sector Number of Data Area - Starting Physical Sector Number of Data Area + 1.

6.26.3.17.8 DVD+R and DVD+R DL Track Size

A DVD+R logical track may be either the collection of all fragments within a closed session or an individual fragment from the open session.

When the specified track is a collection of fragments in a closed session, the track size is calculated using information from the most recent TOC block from the TOC Zone. In this case, the track size is given by *Session end Address - Session Start Address + 1*.

If the specified track is a fragment within the open session, and the fragment is not the invisible fragment, then track size is calculated using information from the most recently written SDCB for the session. In this case track size is given by *Fragment Stop Address – Fragment Start Address + 1*.

If the specified track is the invisible fragment, then track size is calculated using information from the most recently written SDCB for the session and ADIP information. In this case track size is given by *Lead-out Zone Start Address – Fragment Start Address*.

6.26.3.17.9 HD DVD-R Track Size

For HD DVD, the Track/RZone Size field reports the number of sectors in the specified RZone.

The RZone size shall be reported as follows:

For a complete RZone, this field reports the number of sectors in the specified RZone.

The RZone size is calculated as the following rule:

$$RZoneSize = NextRZoneStartAddress - RZoneStartAddress$$

For an incomplete RZone or invisible RZone, this field reports the number of sectors in the specified RZone including unrecorded sectors except the sectors to be used for the Border-out. The end address of the invisible/incomplete RZone is specified by the Outer limit of Data Recordable area field in Data Area Allocation field of Control Data Zone.

The RZone size is calculated as follows:

$$RZoneSize = EndPSNOfRZone - RZoneStartAddress - NumberOfSectorsInBorderOut$$

where the EndPSNOfRZone is the end address of the Invisible/Incomplete RZone. The NumberOfSectorsInBorderOut is the number of sectors to be recorded as Border-out just before the Lead-out.

For a reserved RZone, this field reports the number of sectors in the specified RZone including all unrecorded sectors. The RZone size is calculated as follows:

$$RZoneSize = NextRZoneStartAddress - RZoneStartAddress$$

6.26.3.18 Last Recorded Address

The Last Recorded Address is valid for DVD-R, DVD-R DL when LJRS = 00b, DVD-RW, HD DVD-R, and BD-R. It is the address of last written user data sector of the specified Logical Track. The last written sector of padded sectors shall not be considered as the last written user data sector.

6.26.3.19 Read Compatibility LBA

If the disc is DVD+R and the track is the invisible track (i.e., RT=0), the Read Compatibility LBA shall be present. Some read-only devices are constructed such that a minimal amount of a disc shall be recorded (typically to a radius of 28 – 30 mm) in order that it is acceptable as a valid, readable disc. The Read Compatibility LBA is a padding recommendation from the Drive that the Host may use to ensure a minimal recorded radius.

6.26.3.20 Next Layer Jump Address

The Next Layer Jump Address is the address of the future Layer Jump Address that will cause Layer jump from L0 to L1 or from L1 to L0 of the Reserved/Invisible/Incomplete RZone of DVD-R Dual Layer medium. The reported address is either the address on L0 or the address on L1. If no more Layer jump occurs in the RZone, this field shall be set to 0. So when Layer jump of a Reserved RZone has happened or the RZone is closed, this field shall be set to 0. The default value of the blank DVD-R Dual Layer disc is the end sector address of the L0.

6.26.3.21 Last Layer Jump Address

The Last Layer Jump Address is the address of the last Layer Jump Address on L0. In case of DVD-R Dual Layer medium, only previous Layer Jump Address on L0 is reported. If no Layer jump has happened in the RZone and the NWA is located on L0, this field shall be set to 0. If the RZone is closed status, this field shall report the maximum recorded LBA on L0 in the closed RZone.

When the RZone is Invisible or Incomplete state, the Last Layer Jump Address field and the Next Layer Jump Address fields report the information about Layer Jump Block (LJB).

When the LJRS field is set to 00b and if the Next Layer Jump Address field and Last Layer Jump Address field present after Read Compatibility LBA field, these fields are 00000000h.

6.26.4 Timeouts

The READ TRACK INFORMATION command belongs to timeout group 1. If the command is terminated with CHECK CONDITION status due to a timeout, sense bytes SK/ASC/ASCQ shall be set to UNIT ATTENTION/INSUFFICIENT TIME FOR OPERATION.

6.26.5 Error Reporting

Table 502 describes errors that may occur during the operation of the command or that may cause a CHECK CONDITION status to be reported.

Table 502 — Recommended Errors for the Read Track Information Command

Error	Reference
Unit Attention conditions	Table F.1
CDB or parameter list validation errors	Table F.2
Readiness errors	Table F.3
General media access errors	Table F.5
Read errors	Table F.6
Hardware failures	Table F.8

6.27 REPAIR TRACK Command

6.27.1 Introduction

A track that has been defined for incremental writing on DVD-R/-RW may be damaged due to an incomplete ECC block at the end of written data. This may be caused by a reset issued or a power-fail condition during a write operation. The REPAIR TRACK command shall fill multiple ECC block lengths with data from beginning of the damaged sector of the ECC block and ending with a link field. The recovery is intended only to allow the track to become writable again.

The REPAIR TRACK command is optional for all MM devices. The REPAIR TRACK command is not mandatory under any Feature defined in this standard.

6.27.2 The CDB and Its Parameters

6.27.2.1 The CDB

The REPAIR TRACK CDB is shown in Table 503.

Table 503 — REPAIR TRACK CDB

Bit	7	6	5	4	3	2	1	0
Byte								
0	Operation Code (58h)							
1	Reserved							IMMED
2	Reserved							
3	Reserved							
4	(MSB) Track Number (LSB)							
5								
6	Reserved							
7	Reserved							
8	Reserved							
9	Control							

6.27.2.2 IMMED

If IMMED is zero, the requested repair operation is processed to completion prior to returning status. If IMMED is set to one, status is returned once the CDB has been validated.

6.27.2.3 Track Number

The Track Number field specifies the track that requires repair.

6.27.3 Command Processing

If the Drive is unable to write to the currently mounted medium, error reporting should follow the guidelines according to 4.1.6.3.

Behavior of this command is the same as automatic repair (see the DAMAGE bit description in 6.26.3.7). This command causes a repair action without an explicit write of data.

6.27.4 Timeouts

The REPAIR TRACK command belongs to timeout group 1. If the command is terminated with CHECK CONDITION status due to a timeout, sense bytes SK/ASC/ASCQ shall be set to UNIT ATTENTION/INSUFFICIENT TIME FOR OPERATION.

6.27.5 Error Reporting

Recommended error reporting for the REPAIR TRACK command is defined in Table 504.

Table 504 — Recommended errors for REPAIR TRACK Command

Error	Reference
Unit Attention conditions	Table F.1
CDB or parameter list validation errors	Table F.2
Readiness errors	Table F.3
Protocol errors	Table F.4
General media access errors	Table F.5
Write errors	Table F.7
Hardware failures	Table F.8

6.28 REPORT KEY Command

6.28.1 Introduction

The REPORT KEY command requests the start of the authentication process and provides data necessary for authentication and for generating a Bus Key for protected transfers between the Host and Drive.

This command, in conjunction with the SEND KEY command, is intended to perform authentication for Drives that conform to specified Content Protection schemes, and generates a Bus Key as the result of that authentication.

Table 505 shows the Features associated with the REPORT KEY command.

Table 505 — Features Associated with the REPORT KEY Command

Feature Number	Feature Name	Command Requirement
0106h	DVD CSS	Mandatory
010Bh	DVD CPRM	Mandatory
010Dh	VCPS	Mandatory
0110h	AACS	Mandatory

6.28.2 The CDB and Its Parameters

6.28.2.1 The CDB

The REPORT KEY CDB is shown in Table 506. The actual format of the CDB is dependent upon the value of Key Class.

Table 506 — REPORT KEY CDB

Bit Byte	7	6	5	4	3	2	1	0
0	Operation Code (A4h)							
1	Reserved							
2	(MSB) Reserved /Logical Block Address/Starting Offset (LSB)							
3								
4								
5								
6								
7	Key Class							
8	(MSB) Allocation Length (LSB)							
9								
10	AGID		Key Format					
11	Control							

6.28.2.2 Reserved/Logical Block Address/Starting Offset

The Reserved/Logical Block Address/Starting Offset field is dependent upon the Key Class and Key Format Fields.

6.28.2.3 Reserved/Block Count/VCPS Function

When the Key Class is 02h (AACS) this field is Block Count for some Key Format codes. When the Key Class value is 20h (VCPS) this field contains a VCPS Function code. Otherwise, this field is reserved.

6.28.2.4 Key Class

The Key Class field shall identify the type of authentication conversation according to Table 507.

Table 507 — KEY Class Definition

Key Class	Authentication Type
00h	DVD CSS/CPPM or CPRM
01h	ReWritable Security Service – AS-MO
02h	AACS
03h – 1Fh	Reserved
20h	VCPS
21h – FFh	Reserved

Note 21. DVD CSS/CPPM and CPRM authentication use the same Key Class field value since they have the same Challenge KEY, KEY1, and KEY2 sizes, and since they are licensed through the same entity.

6.28.2.5 Allocation Length

The Allocation Length field specifies the maximum length in bytes of the REPORT KEY response data that shall be transferred from the Drive to the Host. An Allocation Length of zero indicates that no data shall be transferred. This condition shall not be considered as an error.

6.28.2.6 AGID

The AGID field is used to control simultaneous key exchange sequences. The AGID specified in subsequent Key Exchange commands shall match a currently active AGID.

Note 22. Drives that support more than one Key Format for requesting an AGID do not necessarily support simultaneous key exchange sequences.

6.28.2.7 Key Format

The Key Format field indicates the types of information that is to be sent to the Host. The definition for specific Key Format fields is dependent upon the Key Class.

6.28.3 Command Processing

6.28.3.1 Key Class 00h, DVD CSS/CPPM or CPRM

6.28.3.1.1 General

When Key Class is 00h, the Key Format field (Table 508) indicates the types of information that is to be sent to the Host.

Table 508 — Key Format Code definitions for REPORT KEY Command (Key Class 0)

Key Format	Returned Data	Description	AGID Use
000000b	AGID for CSS/CPPM	Returns an AUTHENTICATION GRANT ID for Authentication for CSS/CPPM	Reserved & N/A
000001b	Challenge Key	Returns a Challenge KEY	Valid AGID Required
000010b	KEY1	Returns a KEY1	
000100b	TITLE KEY	Returns a TITLE KEY obfuscated by a Bus Key	
000101b	ASF	Returns the current state of the Authentication Success Flag for CSS/CPPM	Reserved & Ignored
001000b	RPC State	Report Drive region settings	
010001b	AGID for CPRM	Returns an AUTHENTICATION GRANT ID for Authentication for CPRM	Reserved & N/A
111111b	None	Invalidate Specified AGID. Invalidating an invalid AGID shall not be considered an error. An AGID that has not been granted shall be considered invalid	Valid AGID preferred but not required
All other values	Reserved		

6.28.3.1.2 Key Format = 000000b, AGID for CSS/CPMM

This Key Format requests the Drive to return an Authentication Grant ID for CSS/CPMM. If the authentication process is started by the REPORT KEY command with a KEY Format of 000000b, the authentication shall be processed to exchange Key data only for CSS/CPMM protected contents.

Note 23. If the command with this KEY Format is required by an implemented Feature, the command should function, even when the current bit for that Feature is zero.

Table 509 defines the response data for Key Format 000000b.

Table 509 — REPORT KEY Data Format (With KEY Format = 000000b, Key Class = 0)

Bit Byte	7	6	5	4	3	2	1	0
0	(MSB) REPORT KEY Data Length (06h)							(LSB)
1								
2	Reserved							
3	Reserved							
AUTHENTICATION GRANT ID FOR CSS/CPMM								
0	Reserved							
1	Reserved							
2	Reserved							
3	AGID		Reserved					

6.28.3.1.3 Key Format = 000001b, Challenge Key

Challenge Key Value field returns a value to be used to interrogate an external device to determine conformance with the DVD Content Protection scheme. The external device then generates the corresponding KEY2.

Table 510 defines the response data for Key Format 000001b

Table 510 — REPORT KEY Data Format (With KEY Format = 000001b, Key Class = 0)

Bit Byte	7	6	5	4	3	2	1	0	
0	(MSB) REPORT KEY Data Length (0Eh)							(LSB)	
1									
2	Reserved								
3	Reserved								
Challenge Key									
0	(MSB)							Challenge Key Value	(LSB)
:									
9									
10	Reserved								
11	Reserved								

6.28.3.1.4 Key Format = 000010b, KEY1

KEY1 Value field returns a value used to determine the Drive's conformity with DVD Content Protection scheme by an external device. The KEY1 value is also used as a parameter to generate a Bus Key in the Drive.

When the Drive is unable to produce a KEY1 value, this command with KEY Format = 000010b shall be terminated with CHECK CONDITION status and SK/ASC/ASCQ shall be set to ILLEGAL REQUEST/COPY PROTECTION KEY EXCHANGE FAILURE – KEY NOT PRESENT.

Table 511 defines the response data for Key Format 000010b

Table 511 — REPORT KEY Data Format (With KEY Format = 000010b, Key Class = 0)

Bit	7	6	5	4	3	2	1	0	
Byte									
0	(MSB) REPORT KEY Data Length (0Ah)								
1								(LSB)	
2	Reserved								
3	Reserved								
KEY1									
0	(MSB)								
:	KEY1 Value								
4								(LSB)	
5	Reserved								
6	Reserved								
7	Reserved								

6.28.3.1.5 Key Format = 000100b, TITLE KEY

Table 512 defines the response data for Key Format 000100b.

Table 512 — REPORT KEY Data Format (With KEY Format = 000100b, Key Class = 0)

Bit	7	6	5	4	3	2	1	0
Byte								
0	(MSB) REPORT KEY Data Length (0Ah)							
1	(LSB)							
2	Reserved							
3	Reserved							
COPYRIGHT MANAGEMENT/TITLE KEY Information								
0	CPM	CP_SEC	CGMS		CP_MOD			
1	(MSB)							
2	TITLE KEY Value							
3								
4								
5								
6	Reserved							
7	Reserved							

The CPM bit identifies the presence of copyrighted material in this sector. If set to zero the material is not copyrighted, if set to one the material is copyrighted.

When the CPM bit is one, the CP_SEC field indicates that the specified sector has a specific data structure for copyright protection system. If set to zero no such data structure exists in this sector. If set to one, a specific data structure for CSS or CPPM exists in this sector.

When the CPM bit is 1, the CGMS field indicates the restrictions on copying:

00b	Copying is permitted without restriction
01b	Reserved
10b	One generation of copies may be made
11b	No copying is allowed

When the CP_SEC bit is 1, the CP_MOD field indicates the copyright protection mode of the specified sector. A value of 0h indicates the sector is scrambled by CSS. A value of 1h indicates the sector is encrypted by CPPM. Other values are reserved.

The Reserved/Logical Block Address field in the CDB specifies the logical block address that contains the TITLE KEY to be sent to the Host obfuscated by a Bus Key.

The length of Title Key Value is currently 5 bytes only. CPPM protected sectors do not contain a TITLE KEY.

When the TITLE KEY does not exist on the specified sector of DVD media, this command with KEY Format = 000100b shall be terminated with CHECK CONDITION status and SK/ASC/ASCQ shall be set to ILLEGAL REQUEST/COPY PROTECTION KEY EXCHANGE FAILURE/KEY NOT PRESENT.

When the Drive is not in the Bus Key Established state for CSS/CPPM, this command with KEY Format = 000100b shall be terminated with CHECK CONDITION status and SK/ASC/ASCQ shall be set to ILLEGAL REQUEST/COPY PROTECTION KEY EXCHANGE FAILURE – KEY NOT ESTABLISHED.

6.28.3.1.6 Key Format = 000101b, Authentication Success Flag

Table 513 defines the response data for Key Format 000101b.

ASF bit of one indicates that the authentication process for CSS/CPPM has completed successfully.

The ASF value is not relevant to CPPM, since CPPM protected sectors do not contain a Title Key.

Table 513 — REPORT KEY Data Format (With KEY Format = 000101b, Key Class = 0)

Bit	7	6	5	4	3	2	1	0	
Byte									
0	(MSB) REPORT KEY Data Length (06h)								
1								(LSB)	
2	Reserved								
3	Reserved								
AUTHENTICATION SUCCESS FLAG									
0	Reserved								
1	Reserved								
2	Reserved								
3	Reserved								ASF

6.28.3.1.7 Key Format = 001000b, RPC State

Table 514 defines the response data for Key Format 001000b

Table 514 — REPORT KEY Data Format (With KEY Format = 001000b, Key Class = 0)

Bit	7	6	5	4	3	2	1	0
Byte								
0	(MSB) REPORT KEY Data Length (06h)							
1	(LSB)							
2	Reserved							
3	Reserved							
RPC State								
0	Type Code	# of Vendor Resets Available			# of User Controlled Changes Available			
1	Region Mask							
2	RPC Scheme							
3	Reserved							

The Drive shall not report an error concerning media to this KEY Format code.

The Type Code field (Table 515) specifies the current state of the Regionalization process.

Table 515 — Type Code Field Definitions

Type Code	Name	Definition
00b	NONE	No Drive region setting
01b	SET	Drive region is set
10b	LAST CHANCE	Drive Region is set. Additional restrictions required to make a change
11b	PERM	Drive Region has been set permanently, but may be reset by the vendor.

of Vendor Resets Available is a count down counter that indicates the number of times that the vendor may reset the region. The manufacturer of the Drive sets this value to 4 and the value is decremented each time the vendor clears the Drive's region. When this value is zero, the vendor may no longer clear the Drive's region.

of User Controlled Changes Available is a count down counter that indicates the number of times that the user may set the region. This value is initially 5.

The Region Mask returns a value that specifies the Drive Region in which the Drive is located. Once the Drive Region has been set, the Drive shall be located in only one region. Each bit represents one of eight regions. If a bit is cleared in this field, the disc may be played in the corresponding region. If a bit is set in this field, the disc may not be played in the corresponding region.

RPC Scheme specifies the type of Region Playback Controls being used by the Drive. See Table 516.

Table 516 — RPC Scheme field Definition

RPC Scheme	RPC Name	Definition
00h	Unknown	Drive does not enforce Region Playback Controls (RPC)
01h	RPC Phase II	Drive region shall adhere to this standard and all requirements of the CSS license agreement concerning RPC.
02h – FFh	Reserved	

6.28.3.1.8 Key Format = 010001b, AGID for CPRM

Table 517 defines the response data for Key Format 010001b

This KEY Format requests the Drive to return an Authentication Grant ID for CPRM. If the authentication process is started by the REPORT KEY command with a KEY Format of 010001b, the authentication shall be processed to exchange Key data only for CPRM protected contents.

Note 24. If the command with this KEY Format is required by an implemented Feature, the command should function, even when the current bit for that Feature is zero.

Table 517 — REPORT KEY Data Format (With Key Format = 010001b, Key Class = 0)

Bit	7	6	5	4	3	2	1	0
Byte								
0	(MSB)							
1	REPORT KEY Data Length (06h)							(LSB)
2	Reserved							
3	Reserved							
AUTHENTICATION GRANT ID FOR CPRM								
0	Reserved							
1	Reserved							
2	Reserved							
3	AGID		Reserved					

6.28.3.1.9 Key Format = 111111b, Invalidate AGID

6.28.3.1.10 Invalidate Authentication Grant ID for AACS (Key Format = 111111b)

This KEY Format requests the Drive invalidate the specified Authentication Grant ID for AACS. The AGID is specified in the AGID field of the CDB.

No further conversation is allowed over this AGID until it is assigned again with a new REPORT KEY command requesting an AGID. No data is returned by the Drive.

6.28.3.2 Key Class 02h, AACS

The REPORT KEY command with Key Class = 02h is used for AACS authentication process. The REPORT KEY command with Key Class = 02h requests the start of the authentication process, requests data necessary for authentication and for generating a Bus Key, generates and returns or just returns the Binding Nonce and ends the authentication process.

6.28.3.2.1 General

When Key Class is 02h, the Key Format field (Table 518) indicates the type of information that is to be sent to the Host.

Table 518 — Key Format Code definitions for REPORT KEY Command (Key Class 1)

Key Format	Returned Data	Description	AGID Use
00000b	AGID for AACS	Returns an AUTHENTICATION GRANT ID for Authentication for AACS	Reserved & N/A
00001b	Drive Certificate Challenge	Returns a Drive Certificate Challenge	Valid AGID Required
000010b	Drive Key	Returns a Drive Key	
10000b	Binding Nonce	Generates and stores a Binding Nonce and returns it	
100001b	Binding Nonce	Returns a Binding Nonce	Valid AGID preferred but not required
11111b	None	Invalidate Specified AGID for AACS. Invalidating an invalid AGID for AACS shall not be considered an error. An AGID that has not been granted shall be considered invalid.	
All other values	Reserved		

6.28.3.2.2 Authentication Grant ID for AACS (Key Format = 000000b)

This KEY Format (Table 519) requests the Drive to return an Authentication Grant ID for AACS.

Note 25. If the command with this KEY Format is required by an implemented Feature, the command should function, even when the current bit for that Feature is zero.

Table 519 — REPORT KEY Data Format (With KEY Format = 000000b, Key Class = 2)

Bit	7	6	5	4	3	2	1	0	
Byte									
0	(MSB) REPORT KEY Data Length (06h)								
1									(LSB)
2	Reserved								
3	Reserved								
AUTHENTICATION GRANT ID FOR AACS									
0	Reserved								
1	Reserved								
2	Reserved								
3	AGID		Reserved						

The REPORT KEY Data Length field indicates the length in bytes of the following REPORT KEY Data that is available to be transferred to the host. The REPORT KEY Data Length value does not include the REPORT KEY Data Length field itself.

6.28.3.2.3 Drive Certificate Challenge (Key Format = 000001b)

The Drive Certificate Challenge format (Table 520) returns a value by which the Host is able to verify the legitimacy of the Drive.

Table 520 — REPORT KEY Data Format (With KEY Format = 000001b, Key Class = 2)

Bit	7	6	5	4	3	2	1	0	
Byte									
0	(MSB) REPORT KEY Data Length (72h)								
1								(LSB)	
2	Reserved								
3	Reserved								
Drive Certificate Challenge									
0	(MSB)								
:	Drive Certificate Challenge Data								
111								(LSB)	

The REPORT KEY Data Length field indicates the length in bytes of the following REPORT KEY Data that is available to be transferred to the host. The REPORT KEY Data Length value does not include the REPORT KEY Data Length field itself.

The Drive Certificate Challenge Data field is 112 bytes.

6.28.3.2.4 Drive Key (Key Format = 000010b)

The Drive Key Format (Table 521) returns a value that is used, together with the Host Key Data to generate a Bus Key.

Table 521 — REPORT KEY Data Format (With KEY Format = 000010b, Key Class = 2)

Bit	7	6	5	4	3	2	1	0	
Byte									
0	(MSB) REPORT KEY Data Length (52h)								
1								(LSB)	
2	Reserved								
3	Reserved								
Drive Key									
0	(MSB) Drive Key Data								
:									
79								(LSB)	

The REPORT KEY Data Length field indicates the length in bytes of the following REPORT KEY Data that is available to be transferred to the host. The REPORT KEY Data Length value does not include the REPORT KEY Data Length field itself.

The Drive Key Data field returns a value that is used by the Host to generate a Bus Key.

6.28.3.2.5 Binding Nonce generated by the Drive (Key Format = 100000b)

The Binding Nonce format (Table 522) returns a Binding Nonce that is generated by this command with KEY Format = 100000b and stored in the Drive for later recording in a protected manner.

Table 522 — REPORT KEY Data Format (With KEY Format = 100000b, Key Class = 2)

Bit	7	6	5	4	3	2	1	0	
Byte									
0	(MSB) REPORT KEY Data Length (22h)								
1								(LSB)	
2	Reserved								
3	Reserved								
Binding Nonce (Generated in Drive)									
0	(MSB)								
:									
31	Binding Nonce Data								(LSB)

The REPORT KEY Data Length field indicates the length in bytes of the following REPORT KEY Data that is available to be transferred to the host. The REPORT KEY Data Length value does not include the REPORT KEY Data Length field itself.

The Binding Nonce Data field returns 32 byte identifier.

When the Drive is not in the Bus Key established state of the AACS Authentication, this command with KEY Format = 100000b shall be terminated with CHECK CONDITION status and sense bytes SK/ASC/ASCQ shall be set to ILLEGAL REQUEST/COPY PROTECTION KEY EXCHANGE FAILURE - KEY NOT ESTABLISHED.

6.28.3.2.6 Binding Nonce (read from the medium) (Key Format = 100001b)

The Binding Nonce format (Table 523) returns a Binding Nonce that is read from the designated LBA Extent by this command with KEY Format = 100001b in a protected manner.

Table 523 — REPORT KEY Data Format (With KEY Format = 100001b, Key Class = 2)

Bit	7	6	5	4	3	2	1	0	
Byte									
0	(MSB) REPORT KEY Data Length (22h)								
1								(LSB)	
2	Reserved								
3	Reserved								
Binding Nonce (Read from Medium)									
0	(MSB)								
:	Binding Nonce Data								
31								(LSB)	

The REPORT KEY Data Length field indicates the length in bytes of the following REPORT KEY Data that is available to be transferred to the host. The REPORT KEY Data Length value does not include the REPORT KEY Data Length field itself.

The Binding Nonce Data field returns a 32 byte identifier.

When the Drive is not in the Bus Key established state of the AACS Authentication, this command with KEY Format = 100001b shall be terminated with CHECK CONDITION status and sense bytes SK/ASC/ASCQ shall be set to ILLEGAL REQUEST/COPY PROTECTION KEY EXCHANGE FAILURE - KEY NOT ESTABLISHED.

6.28.3.2.7 Invalidate Authentication Grant ID for AACS (Key Format = 111111b)

This KEY Format requests the Drive invalidate the specified Authentication Grant ID for AACS. The AGID is specified in the AGID field of the CDB.

No further conversation is allowed over this AGID until it is assigned again with a new REPORT KEY command requesting an AGID. No data is returned by the Drive.

6.28.3.3 Key Class 20h, VCPS**6.28.3.3.1 General**

The VCPS Function code specifies the VCPS function to be performed. VCPS Functions are listed in Table 524. If the VCPS Function code is a reserved value, the command shall be terminated with CHECK CONDITION status and sense bytes SK/ASC/ASCQ values shall be set to ILLEGAL REQUEST/INVALID PARAMETER IN CDB.

Table 524 — VCPS Functions for REPORT KEY

VCPS Function Code	VCPS Function	Description
00h	Reserved	—
01	DKB	Return Disc Key Block
02	Device ID	Return Device ID
03	Key Contribution	Return Drive's Key Contribution
04	DKB Hash & Unique ID	Return the DKB Hash & Unique ID combined and encrypted
05	DKB Information	Return DKB Information
06 - FFh	Reserved	—

If CDB is validated, but the Disc is not VCPS Capable, the Drive shall terminate the command with CHECK CONDITION status and set sense bytes SK/ASC/ASCQ to ILLEGAL REQUEST/SYSTEM RESOURCE FAILURE.

6.28.3.3.2 VCPS Function Code = 01h, DKB

When the VCPS function is 01h, the REPORT KEY command shall return the DKB.

If the Drive represents a read-only device, the DKB shall be returned from Buffer Zone 2.

If the Drive represents a Recorder device, the command execution shall proceed as follows:

1. If the DKB is contained in Buffer Zone 2, the Drive, the DKB structure shall be returned to the Host and the command shall be terminated with GOOD status.

If no DKB is found in Buffer Zone 2, but the DKB is contained in the Initial Zone, the Drive shall generate a new Unique ID. The Drive shall write the DKB and the Unique ID into Buffer Zone 2. If an unrecoverable error occurs during this process, the Drive shall terminate the command with CHECK CONDITION status and set sense bytes SK/ASC/ASCQ to ILLEGAL REQUEST/SYSTEM RESOURCE FAILURE. Otherwise, the Drive shall return the DKB, write the DKB into Buffer Zone 2, and terminate with GOOD status. If the media is DVD+R, the drive shall also zero-fill write the first ECC block of the data zone (LBA 0, 1, 2 ..., 15).
2. If no DKB is found in either Buffer Zone 2 or the Initial Zone, the DKB is contained in the ADIP. The Drive shall completely retrieve the DKB from the DKB region in the ADIP; the Drive shall generate a new Unique ID. The Drive shall write the DKB and the Unique ID in Buffer Zone 2. If an unrecoverable error occurs during this process, the Drive shall terminate the command with CHECK CONDITION status and set sense bytes SK/ASC/ASCQ to ILLEGAL REQUEST/SYSTEM RESOURCE FAILURE. Otherwise, the Drive shall return the DKB, write the DKB into Buffer Zone 2, and terminate with GOOD status. If the media is DVD+R, the drive shall also zero-fill write the first ECC block of the data zone (LBA 0, 1, 2 ..., 15).
3. If a DKB is not found on the Disc, the Drive shall terminate the command with CHECK CONDITION status. In addition the Drive shall set sense bytes SK/ASC/ASCQ to ILLEGAL REQUEST/SYSTEM RESOURCE FAILURE.

The format of the returned data is defined in Table 525.

Table 525 — VCPS Key Class REPORT KEY returned data, DKB

Bit Byte	7	6	5	4	3	2	1	0
0	(MSB) Data Length = N+2							(LSB)
1								
2	Reserved							
3	Reserved							
DKB data								
0	(MSB) DKB							(LSB)
...								
L-1								
...	P Zero Padding bytes							
N-1								

The Data Length (= N) contains the length of the structure not including the Data Length field.

The DKB field contains the EKB structure.

If L is not a multiple of 4, then P = 1, 2 or 3 zero padding bytes shall be appended in order that N is an integral multiple of 4. Consequently, the structure data length is N = L+P.

6.28.3.3.3 VCPS Function Code = 02h, Device ID

When the VCPS function is 02h, the REPORT KEY command shall return Device ID₀ of the Drive. This assists the functionality of step 1 in the authentication protocol (see 4.10.4.2). The Drive shall return Device ID₀ and terminate with GOOD status. If a previous execution of the authentication protocol is in progress, the Drive shall abort that previous execution of the authentication protocol. The format of the returned data is defined in Table 526.

Table 526 — VCPS Key Class REPORT KEY returned data, Device ID

Bit Byte	7	6	5	4	3	2	1	0
0	(MSB) Data Length = 26h							
1	(LSB)							
2	Reserved							
3	Reserved							
Device ID data								
0	Reserved							
...								
30								
31	(MSB) Device ID							
...	Device ID							
35								

The Data Length field shall contain 38 (26h).

Each byte of the reserved field shall be set to zero (00h).

The Device ID field contains the Device ID of the VCPS Capable Drive.

6.28.3.3.4 VCPS Function Code = 03h, Key Contribution

When the VCPS function is 03h, the REPORT KEY command shall return the key contribution QD of the Drive. This assists the functionality of step 4 in the authentication protocol (see 4.10.4.2). The command execution shall proceed as follows:

1. If the authentication sequence has been violated, the Drive shall terminate the command with CHECK CONDITION status. In addition the Drive shall set sense bytes SK/ASC/ASCQ to ILLEGAL REQUEST/COMMAND SEQUENCE ERROR. A retry of the authentication protocol shall start from step 1.
2. Otherwise, the Drive shall return its key contribution QD and terminate with GOOD status.

The format of the returned data is defined in Table 527.

Table 527 — VCPS Key Class REPORT KEY returned data, Key Contribution

Bit Byte	7	6	5	4	3	2	1	0
0	(MSB) Data Length = 26h							
1	(LSB)							
2	Reserved							
3	Reserved							
Key Contribution data								
0	Reserved							
...								
3								
4	(MSB) Encrypted Random Numbers 1							
...								
19	(LSB)							
20	(MSB) Encrypted Drive Key Contribution							
...								
35	(LSB)							

The Data Length field shall contain 38 (26h).

Each byte of the reserved field shall be set to zero (00h).

The Encrypted Random Numbers 1 field contains the random number (RA) of the Application, the random number (RD) of the Drive combined with IV2 and encrypted using the Root Key KR_{auth} . IV2 is a 128-bit licensed constant.)

The Encrypted Drive Key Contribution field contains the key contribution (QD) of the Drive, encrypted using the Root Key KR_{auth} and combined with Encrypted Random numbers 1.

6.28.3.3.5 VCPS Function Code = 04h, DKB Hash and Unique ID

When the VCPS function is 04h, the REPORT KEY command shall return the DKB hash value and Unique ID. This assists the functionality of step 8 in the authentication protocol (see 4.10.4.2).

The command execution shall proceed as follows:

1. If the Drive has aborted the authentication protocol in a previous step, the command shall be terminated with CHECK CONDITION status and sense bytes SK/ASC/ASCQ shall be set to ILLEGAL REQUEST/COMMAND SEQUENCE ERROR. The Application may retry authentication beginning with step 1 (see 4.10.4.2) of the authentication sequence.
2. If the Host has not retrieved the DKB and Unique ID during this authentication sequence, the command shall be terminated with CHECK CONDITION status and sense bytes SK/ASC/ASCQ shall be set to ILLEGAL REQUEST/COMMAND SEQUENCE ERROR.
3. Otherwise, the Drive shall return the DKB Hash and Unique ID, and terminate with GOOD status. The format of the returned data is defined in Table 528.

Table 528 — VCPS Key Class REPORT KEY returned data, DKB Hash & Unique ID

Bit	7	6	5	4	3	2	1	0	
Byte									
0	Data Length = 26h								
1									(LSB)
2	Reserved								
3	Reserved								
DKB Hash and Unique ID									
0	Reserved								
...									
3									
4	Encrypted DKB Hash								
...									
19									(LSB)
20									Encrypted Unique ID
...									
35	(LSB)								

The Data Length field shall contain 38 (26h).

Each byte of the reserved field shall be set to zero (00h).

The Encrypted DKB Hash field contains the DKB Hash value combined with IV2, encrypted using the Bus Key KB. IV2 is a 128-bit licensed constant.

A Drive that has playback-only functionality shall set the DKB Hash field to all zeros, prior to encryption. A Drive that has recording functionality shall retrieve the DKB hash value from the hash region contained in the ADIP.

The Encrypted Unique ID field contains the Unique ID, encrypted using the Bus Key KB and combined with the encrypted DKB Hash.

If the mounted medium is read-only (i.e. without ADIP structures), the Drive shall set the DKB Hash field to all zeros, prior to encryption.

6.28.3.4 VCPS Function Code = 05h, DKB Information

When the VCPS function is 05h, the REPORT KEY command shall return the information with respect to the DKB. This information may be required for step 8 of the authentication protocol (see 4.10.4.2). The format of the returned data is shown in Table 529.

Table 529 — VCPS Key Class REPORT KEY returned data, DKB Hash & Unique ID

Bit	7	6	5	4	3	2	1	0	
Byte									
0	(MSB) Data Length = 000Eh								
1								(LSB)	
2	Reserved								
3	Reserved								
DKB Information									
0	DKB size								
...									
3									
4	DKB bytes collected								
...									
7									
8									Reserved
9	Reserved								
...									
11									

The Data Length field shall be set to 14 (000Eh).

The DKB size field contains the size in bytes of the DKB.

The DKB bytes collected is the number of DKB bytes that the Drive has collected so far. If the Drive is required to retrieve the DKB from the DKB region in the ADIP, DKB Bytes Collected may be less than DKB Size. If the Drive is able to retrieve the DKB from the Initial Zone, DKB Bytes Collected shall be equal to DKB Size. If the Drive is able to retrieve the DKB from Buffer Zone 2, DKB Bytes Collected shall be equal to DKB Size.

The bit flags in byte 8 of the Key Contribution data specifies the DKB locations:

If DKB_AD = 1, the Disc contains a DKB in the DKB region in the ADIP, otherwise no DKB was found in the DKB region in the ADIP.

If DKB_IZ = 1, the Disc contains an DKB in the Initial Zone, otherwise no DKB was found in the Initial Zone.

If DKB_BZ = 1, the Disc contains a DKB in Buffer Zone 2, otherwise no DKB was found in Buffer Zone 2.

6.28.4 Timeouts

The REPORT KEY command belongs to timeout group 1. If the command is terminated with CHECK CONDITION status due to a timeout, sense bytes SK/ASC/ASCQ shall be set to UNIT ATTENTION/INSUFFICIENT TIME FOR OPERATION.

6.28.5 Error Reporting

Recommended error reporting for the REPORT KEY command is defined in Table 530.

Table 530 — Recommended errors for REPORT KEY Command

Error	Reference
Unit Attention conditions	Table F.1
CDB or parameter list validation errors	Table F.2
General media access errors	
Hardware failures	Table F.8

6.29 REQUEST SENSE Command

6.29.1 Introduction

The REQUEST SENSE command requests that the Drive transfer sense data to the Initiator.

Table 531 shows the Features associated with the REQUEST SENSE command.

Table 531 — Features Associated with the REQUEST SENSE Command

Feature Number	Feature Name	Command Requirement
0001h	Core	Mandatory
0023h	Formattable	Mandatory

The REQUEST SENSE command is described in [SPC-3].

MM Drives that support only a 32-bit LBA format, shall return only fixed format sense data. Such MM Drives may ignore the setting of the Desc bit in the REQUEST SENSE command CDB.

6.29.2 Timeouts

Timeouts are not defined for the REQUEST SENSE command.

6.29.3 Error Reporting

Recommended error reporting for the REQUEST SENSE command is defined in Table 532.

Table 532 — Recommended errors for REQUEST SENSE Command

Error	Reference
CDB or parameter list validation errors	
Hardware failures	Table F.8

6.30 RESERVE TRACK Command

6.30.1 Introduction

The RESERVE TRACK command allows reservation of disc space for a logical track.

Table 533 shows the Features associated with the RESERVE TRACK command.

Table 533 — Features Associated with the RESERVE TRACK Command

Feature Number	Feature Name	Command Requirement
0021h	Incremental Streaming Writable	Mandatory
002Bh	DVD+R	Mandatory (when Write bit is set to one)
002Dh	CD Track At Once	Mandatory
002Fh	DVD-R/-RW Write	Mandatory
003Bh	DVD+R DL	Mandatory (when Write bit is set to one)
0051h	HD DVD Write	Mandatory for HD DVD-R

6.30.2 The CDB and Its Parameters

6.30.2.1 The CDB

The RESERVE TRACK CDB is shown in Table 534.

Table 534 — RESERVE TRACK CDB

Bit Byte	7	6	5	4	3	2	1	0
0	Operation Code (53h)							
1	Reserved						RMZ	ARSV
2	Logical Track Reservation Parameter							
3								
4								
5								
6								
7								
8								
9	Control							

6.30.2.2 RMZ

The RMZ bit applies only to HD DVD-R. The RMZ bit indicates the type of reservation as shown in Table 535.

Table 535 — RMZ bit definition

RMZ	Definition
0	Logical Track reservation
1	U-RMZ (HD DVD)

If RMZ is set to one and the currently mounted disc is not HD DVD-R, the command shall be terminated with CHECK CONDITION status and sense bytes SK/ASC/ASCQ shall be set to ILLEGAL REQUEST/INVALID FIELD IN CDB.

If RMZ is set to one and ARSV is set to one, the command shall be terminated with CHECK CONDITION status and sense bytes SK/ASC/ASCQ shall be set to ILLEGAL REQUEST/INVALID FIELD IN CDB.

6.30.2.3 ARSV

The ARSV bit defines the format of the Logical Track Reservation Parameter.

6.30.2.4 Logical Track Reservation Parameter

When ARSV is set to zero, the Logical Track Reservation Parameter has the Reservation Size format (Table 536).

Table 536 — Reservation Size form of Logical Track Reservation Parameter

Bit Byte	7	6	5	4	3	2	1	0	
0	Reserved								
1	Reserved								
2	Reserved								
3	(MSB)	Reservation Size						(LSB)	
4									
5									
6									

A Logical Track is to be reserved with starting address equal to the starting address of the invisible/incomplete track. The Reservation Size field contains the number of user blocks desired for the track reservation. The actual number of blocks allocated is calculated according to the currently mounted media and may be influenced by the Write Parameters Mode Page (See 7.5). Rounding is permitted. In all cases, if Reservation Size is larger than available space, the command shall be terminated with CHECK CONDITION status and SK/ASC/ASCQ values shall be set to ILLEGAL REQUEST/INVALID PARAMETER IN CDB. If Reservation Size is set to zero, the command should be terminated with CHECK CONDITION status and SK/ASC/ASCQ values shall be set to ILLEGAL REQUEST/INVALID FIELD IN CDB. When ARSV is set to one, the Logical Track Reservation Parameter has the LBA format (Table 537).

Table 537 — LBA form of Logical Track Reservation Parameter

Bit Byte	7	6	5	4	3	2	1	0	
0	(MSB)	Reservation LBA						(LSB)	
1									
2									
3									
4	Reserved								
5	Reserved								
6	Reserved								

If Logical Block Address is within the logical address space of the currently mounted disc, then it belongs to some Logical Track. The existing Logical Track keeps its Start Address, but its last LBA is changed to Reservation LBA – 1. A new logical track is created with Start LBA set to the Reservation LBA unless:

1. If Reservation LBA is greater than the largest possible user data area LBA for this disc, the command shall be terminated with CHECK CONDITION status and SK/ASC/ASCQ values shall be set to ILLEGAL REQUEST/ LOGICAL BLOCK ADDRESS OUT OF RANGE.

2. Logical Tracks shall begin with the first block of a writable unit. If the LBA is not the address of the first block of a writable unit, the command shall be terminated with CHECK CONDITION status and SK/ASC/ASCQ values shall be set to ILLEGAL REQUEST/ INVALID FIELD IN CDB.
3. The second track of a split shall be blank. If the track is closed or Reservation LBA is less than the NWA of the logical track that contains the LBA, then the command shall be terminated with CHECK CONDITION status and SK/ASC/ASCQ values shall be set to ILLEGAL REQUEST/INVALID ADDRESS FOR WRITE.
4. It is not permitted to use track splitting to create a Logical Track with a length less than 32. If Reservation LBA = Logical Track Start Address of any Logical Track, then the command shall be terminated with CHECK CONDITION status and SK/ASC/ASCQ values shall be set to ILLEGAL REQUEST/ INVALID FIELD IN CDB.

If Reservation by LBA is not supported for the currently mounted disc, then the command shall be terminated with CHECK CONDITION status and SK/ASC/ASCQ values shall be set to ILLEGAL REQUEST/INVALID FIELD IN CDB.

6.30.3 Command Processing

6.30.3.1 General

If the Drive is unable to write to the currently mounted medium, error reporting should follow the guidelines according to 4.1.6.3.

There are 3 kinds of reservation:

1. RMZ Reservation
2. Logical Track Reservation by Reservation Size
3. Logical Track Reservation by Reservation LBA

6.30.3.2 RMZ Reservation

If the RMZ bit is set to 1b, the Reservation Size field is ignored and the Drive shall reserve a RMZ with 128 ECC blocks in size.

6.30.3.3 Track Reservation by Reservation Size

A new logical track shall be created from the invisible/incomplete track.

Regardless of media type, allowing an attempt to reserve a track when the invisible track is not blank is not recommended. The preferred behavior is: the command should be terminated with CHECK CONDITION status and sense bytes SK/ASC/ASCQ should be set to ILLEGAL REQUEST/COMMAND SEQUENCE ERROR.

6.30.3.3.1 Track Reservation by Reservation Size on CD-R/RW

If Reservation Size is less than 300 (4 seconds), the command shall be terminated with CHECK CONDITION status and SK/ASC/ASCQ values shall be set to ILLEGAL REQUEST/INVALID PARAMETER IN CDB.

The PMA start time shall reflect the appropriate pre-gap, as determined by the previous track's mode and the settings of the Write Parameters Page. Table 538 specifies the PMA stop time, and Track sizing.

Table 538 — Track Reservation on CD-R/RW Media

Write Parameters Mode Page Write Type Value	Description
Session-at-once	CHECK CONDITION status is returned and SK/ASC/ASCQ is set to ILLEGAL REQUEST/COMMAND SEQUENCE ERROR
Track-at-once	The number of user blocks specified shall be reserved. The PMA stop time shall be $PMAStart + ReservationSize + 2$.
Variable Packet	Reserve behaves as in the Track-At-Once case. The Host should be aware that packet linkage overheads is taken from the user space.
Fixed Packet	Set $p = \frac{ReservationSize}{PacketSize}$ packets, where packet size is taken from the Write Parameters Page. If p is an integer, then the reservation is performed with PMA stop time set to $PMAStart + (PacketSize + 7) \cdot p - 5$. If p is not an integer, the command shall be terminated with CHECK CONDITION status and SK/ASC/ASCQ is set to ILLEGAL REQUEST/INVALID FIELD IN CDB.

6.30.3.3.2 Track (RZone) Reservation by Reservation Size on DVD-R/-RW and DVD-R DL

Reservation Size is given as a count of 2 KB sectors. If this number is not an integral multiple of 16, then the Drive shall round up to the next integral multiple of 16. A Logical Track always begins with the first sector of an ECC block.

Table 539 — Track Reservation on DVD-R/-RW Media

Write Parameters Mode Page Write Type Value	Reserved Track Size
Disc-at-once	Reserves the number of user blocks specified. The Reserved Track shall be $ReservedTrackSize = ReservationSize$.
Incremental and layer jump	Reserves the number of user blocks specified. The Reserved Track Size shall be $ReservedTrackSize = 16 \cdot Ceil \left[\frac{ReservationSize + (NWA \& 0Fh)}{16} \right] - (NWA \& 0Fh) + SizeOfLLA$ <p>where <i>ReservationSize</i> is a value that is specified in the CDB. <i>NWA</i> is a Next Writable Address of invisible Track. & means mathematical AND. For Incremental recording, the <i>SizeOfLLA</i>=16. For Layer Jump recording, the <i>SizeOfLLA</i>=16 when no L1 part exists and the <i>SizeOfLLA</i>=32 when the L1 part exists. <i>Ceil</i> (<i>x</i>) returns the least integer value greater than or equal to <i>x</i>.</p>

6.30.3.3.3 Track Reservation on by Reservation Size on DVD+R and DVD+R DL

Reservation Size is given as a count of 2 KB sectors. If this number is not an integral multiple of 16, then the Drive shall round to the next integral multiple of 16. This is the value used by the Drive. A Logical Track always begins with the first sector of an ECC block. A run-in ECC block shall be written between any two tracks within a session just prior to writing the first ECC block of the following track. The run-in ECC block does not belong to either the previous or the new track. If this track is the first track of a session, then no run-in block shall be allocated.

6.30.3.3.4 Track Reservation by Reservation Size on HD DVD-R

The Logical Track is reserved using the number of user blocks specified in the CDB. The Reserved Logical Track Size shall be

$$ReservedTrackSize = 32 \cdot Ceil\left(\frac{ReservationSize}{32}\right)$$

where *ReservationSize* is the value specified in the CDB. Ceil(x) returns the least integer value greater than or equal to x.

6.30.3.3.5 Track Reservation on by Reservation Size on BD-R

Reservation Size is given as a count of 2 KB sectors. If this number is not an integral multiple of 32, then the Drive shall round to the next integral multiple of 32. This is the value used by the Drive. A Logical Track always begins with the first sector of a Cluster.

6.30.3.4 Track Reservation by Reservation LBA

6.30.3.4.1 General

Track Reservation by Reservation LBA splits a Logical Track into two Logical Tracks. Reservation LBA specifies the start address of the second (new) Logical Track. Based on media type, some restrictions may apply.

6.30.3.4.2 Track Reservation by Reservation LBA on CD-R/RW

Reservation LBA shall belong to the invisible track and shall be greater than the NWA of that track. Otherwise, the command shall be terminated with CHECK CONDITION status and SK/ASC/ASCQ values shall be set to ILLEGAL REQUEST/INVALID PARAMETER IN CDB.

Reservation LBA shall allow for the appropriate pre-gap on the new invisible track. Otherwise, the command shall be terminated with CHECK CONDITION status and SK/ASC/ASCQ values shall be set to ILLEGAL REQUEST/INVALID PARAMETER IN CDB.

If *Reservation LBA – Track Start Address* < 298, the command shall be terminated with CHECK CONDITION status and SK/ASC/ASCQ values shall be set to ILLEGAL REQUEST/INVALID PARAMETER IN CDB.

If *LastPossibleLead-OutStartAddress - NewTrackStartAddress* < 298, the command shall be terminated with CHECK CONDITION status and SK/ASC/ASCQ values shall be set to ILLEGAL REQUEST/INVALID PARAMETER IN CDB.

The PMA start time shall reflect the appropriate pre-gap, as determined by the previous track's mode and the settings of the Write Parameters Page.

6.30.3.4.3 Track Reservation by Reservation LBA on DVD-R/-RW, DVD-R DL, and HD DVD-R

Reservation LBA shall belong to the invisible track and shall be greater than the NWA of that track. Otherwise, the command shall be terminated with CHECK CONDITION status and SK/ASC/ASCQ values shall be set to ILLEGAL REQUEST/INVALID PARAMETER IN CDB.

6.30.3.4.4 Track Reservation by Reservation LBA on DVD+R and DVD+R DL

Reservation LBA shall belong to the invisible track and shall be greater than the NWA of that track. Otherwise, the command shall be terminated with CHECK CONDITION status and SK/ASC/ASCQ values shall be set to ILLEGAL REQUEST/INVALID PARAMETER IN CDB.

Reservation LBA shall allow for run-in block prior to the new invisible track. Otherwise, the command shall be terminated with CHECK CONDITION status and SK/ASC/ASCQ values shall be set to ILLEGAL REQUEST/INVALID PARAMETER IN CDB.

6.30.3.4.5 Track Reservation by Reservation LBA on BD-R

When a logical track is split by specifying the start LBA of the new track, the new Logical Track shall be blank. If Reservation LBA is in logical track N, then the new track with start address equal to Reservation LBA shall be numbered N+1. If M is a logical track and M > N prior to the track split, then it shall be numbered M+1 after the track split.

6.30.4 Timeouts

The RESERVE TRACK command belongs to timeout group 2. The group 2 timeout value is only for Host information. The Drive shall not time group 2 timeout commands. Execution shall continue until completion.

6.30.5 Error Reporting

Recommended error reporting for the RESERVE TRACK command is defined in Table 540.

Table 540 — Recommended errors for RESERVE TRACK Command

Error	Reference
Unit Attention conditions	Table F.1
CDB or parameter list validation errors	Table F.2
Readiness errors	Table F.3
General media access errors	Table F.5
Hardware failures	Table F.8

6.31 SEEK (10) Command

6.31.1 Introduction

The SEEK (10) command requests that the Drive seek to the specified logical block address. This command allows the Host to provide advanced notification that particular data may be requested in a subsequent command.

6.31.2 The CDB and Its Parameters

6.31.2.1 The CDB

The SEEK (10) CDB is shown in Table 541.

Table 541 — SEEK (10) CDB

Bit Byte	7	6	5	4	3	2	1	0
0	Operation Code (2Bh)							
1	Reserved							
2	(MSB) Logical Block Address (LSB)							
3								
4								
5								
6								
7	Reserved							
8	Reserved							
9	Control Byte							

6.31.2.2 Logical Block Address

The Logical Block Address field specifies the destination of the SEEK command. The Logical Block Address should be less than or equal to the capacity address returned by the READ CAPACITY command.

6.31.3 Command Processing

The SEEK command may return completion status once the seek operation has been started. The operation should be completed prior to beginning execution of the next command.

If the currently mounted medium is CD-RW with MRW formatting operating in background, DVD+RW with basic formatting operating in background, or DVD+RW with MRW formatting operating in background, the SEEK command operation shall be as follows:

3. If any of the sectors within the range specified by the CDB are in a blank area of the media where format writing has not yet occurred, the seek need not be performed.
4. If all of the sectors within the range specified by the CDB are in an area of the media where format writing has occurred, the command shall operate normally.

6.31.4 Timeouts

The SEEK (10) command belongs to timeout group 1. If the command is terminated with CHECK CONDITION status due to a timeout, sense bytes SK/ASC/ASCQ shall be set to UNIT ATTENTION/INSUFFICIENT TIME FOR OPERATION.

6.31.5 Error Reporting

Recommended error reporting for the SEEK (10) command is defined in Table 542.

Table 542 — Recommended errors for SEEK (10) Command

Error	Reference	May be Deferred
Unit Attention conditions	Table F.1	
CDB or parameter list validation errors	Table F.2	
Readiness errors	Table F.3	
General media access errors	Table F.5	√
Hardware failures	Table F.8	√

6.32 SEND CUE SHEET Command

6.32.1 Introduction

A Session-at-once recording is written beginning with the Lead-in and continuing through the Lead-out. Only user data is sent with the write commands, so a guide structure is required by the Drive in order to control the recording process. This guide structure is called the cue sheet. The cue sheet is constructed in the Host and sent to the Drive.

Table 543 shows the Features associated with the SEND CUE SHEET command.

Table 543 — Features Associated with the SEND CUE SHEET Command

Feature Number	Feature Name	Command Requirement
002Eh	CD Mastering (SAO)	Mandatory

6.32.2 The CDB and Its Parameters

6.32.2.1 The CDB

The SEND CUE SHEET CDB is shown in Table 544.

Table 544 — SEND CUE SHEET CDB

Bit Byte	7	6	5	4	3	2	1	0	
0	Operation Code (5Dh)								
1	Reserved								
2	Reserved								
3	Reserved								
4	Reserved								
5	Reserved								
6	(MSB)	Cue Sheet Size							
7									
8									(LSB)
9	Control Byte								

6.32.2.2 Cue Sheet Size

The Cue Sheet Size parameter is the number of bytes in the cue sheet to be sent to the Drive. Prior to beginning the write process, the entire Cue Sheet shall be received by the Drive. If the Drive is unable to accept and buffer the entire cue sheet, then CHECK CONDITION is returned and SK/ASC/ASCQ values are set to ILLEGAL REQUEST/INVALID FIELD IN CDB.

6.32.3 Command Processing

6.32.3.1 General

If the Write Parameters Page does not have Write Type set to Session-at-once, then CHECK CONDITION status is returned and SK/ASC/ASCQ values are set to ILLEGAL REQUEST/COMMAND SEQUENCE ERROR. If the Write Mode in the Write Parameters Mode Page, is changed from session at once, the Cue sheet may not be available.

The Cue Sheet contains information required to specify the layout of a disc to be written, and shall be sent to the Drive via the SEND CUE SHEET command before writing data to the disc.

The Cue Sheet format is shown in Table 545.

Table 545 — Cue Sheet format

Byte Number	Cue Sheet Data
0	Mixture of
...	Information of absolute disc location, catalog Code,
(m-1)* 8	and ISRC (total m lines)

If the Catalog Code is to be recorded, it shall be described at the beginning of the Cue sheet.

If the ISRC is to be recorded, it shall be described immediately preceding each Track's information in the Cue Sheet.

For the Cue sheet, the Lead-out start time shall be the last entry.

6.32.3.2 Information of the Absolute Disc Location

The Drive writes a disc according to this information. This information defines the following parameters:

1. Generation of Sub-channel P and Q channel.
2. Format and block size of the data transferred by the WRITE command

Table 546 — Sample CUE SHEET

Byte Number	CTL/ ADR	TNO	INDEX	DATA FORM	SCMS	ABSOLUTE TIME		
						MIN	SEC	FRAME
00 (Lead-in)	01h ⁵	00h	00h ¹	01h ⁵	00h	00h ¹	00h ¹	00h ¹
08 (TNO:01)	01h	01h	00h	01h	00h	00h	00h	00h
10 (TNO:01) ²	01h	01h	01h	00h	00h	00h	02h	00h
18 (TNO:02)	01h	02h	00h	C0h	00h	07h	29h	71h
20 (TNO:02)	01h	02h	01h	C0h	00h	07h	31h	71h
28 (TNO:03)	01h	03h	01h	C0h	00h	14h	18h	03h
30 (TNO:04) ⁴	41h	04h	00h	10h	00h	19h	06h	62h
38 (TNO:04)	41h	04h	01h	10h	00h	19h	09h	62h
40 (TNO:05) ⁴	41h	05h	00h	11h	00h	27h	37h	10h
48 (TNO:05)	41h	05h	01h	10h	00h	27h	40h	10h
50 (TNO:06)	01h	06h	00h	01h	80h ⁶	38h	53h	23h
58 (TNO:06)	01h	06h	01h	00h	80h ⁶	38h	55h	23h
60 (Lead-out)	01h ⁵	AAh	01h ³	01h ⁵	00h	56h	37h	46h

1. Always zero for Lead-in except when DATA FORM is set to 41h.
2. The first information track on a disc is preceded by a pause encoding of 2-3 seconds. (If the first track is a Data track, this track does not contain pause encoding, but always contains a "pause" of 2 seconds of pre-gap).
3. Always 01h for Lead-out
4. Pre-gap
5. For the Lead-out area the DATA FORM shall be one. For Lead-in, DATA FORM shall be either 01h or 41h. The control mode of the first track is specified. All data for both Lead-in and Lead-out shall be generated by the Drive except if DATA FORM 41h is selected for the Lead-in.
6. Copy

This information is composed of data units of 8 bytes (1 line). The information consists of three parts:

- 1) The Lead-in area, and contains only one data unit.
- 2) The Program area, that contains data units.
- 3) The Lead-out area, and contains one or more data units.

The data units in Program Area and Lead-out area are in Absolute Time order from the start time of index = 0 of the first track of the session.

Each data unit of Program area and Lead-out area indicates that the value of each field (CONTROL, TNO, X, DATA FORM or ZERO) changes at the time shown in ABSOLUTE TIME field.

Table 547 — Cue Sheet Data

CTL/ ADR	TNO	INDEX	DATA FORM	SCMS	ABSOLUTE TIME		
					Min	Sec	Frame
01h	02h	01h	C0h	00h	07h	31h	71h
01h	03h	01h	C0h	00h	14h	18h	03h

The above data unit indicates that the value of TNO changes from 02 to 03 when ABSOLUTE TIME is 14:18:03 MSF.

6.32.3.3 Control/Address Field

The CTL/ADR byte contains the Control field in the upper 4 bits and the ADR in the lower 4 bits. Refer to Table 548.

Table 548 — CTL/ADR byte

7	6	5	4	3	2	1	0
CTL Field				ADR Field			

6.32.3.4 CTL Field (upper 4 bits)

The CTL (Control) field contains 4 bits that define the kind of information in a track. The definition is shown in Table 549.

Table 549 — Control Field

Bit 7	Bit 6	Bit 5	Bit 4	Definition
0	0	x	0	2 audio channels without pre-emphasis
1	0	x	0	4 audio channels without pre-emphasis
0	0	x	1	2 audio channels with pre-emphasis of 50/15 μ s.
1	0	x	1	4 audio channels with pre-emphasis of 50/15 μ s.
0	1	x	0	Data track
x	x	0	x	digital copy prohibited
x	x	1	x	digital copy permitted

The bits of the Control field (except for the copy bit) shall only be changed during an actual pause (Index = 00) of at least 2 seconds and during Lead-in area.

6.32.3.5 ADR Field (lower 4 bits)

Table 550 defines the codes found in the ADR Field.

Table 550 — ADR Field

Bit 3	Bit 2	Bit 1	Bit 0	Definition
0	0	0	1	start time at TNO/IDX
0	0	1	0	CATALOG CODE
0	0	1	1	ISRC CODE
All other codes are reserved for future use.				

Control shall be the same for each entry associated with a particular track except for first part of pre-gap.

6.32.3.6 TNO

The TNO field indicates track number. Although the TNO field appears in BCD on the media, this field shall contain the binary equivalent. Each track has a minimum length of 4 seconds, not including the pause length preceding the track.

6.32.3.7 INDEX Field

INDEX field is the current value of the index number. Although the INDEX field appears in BCD on the media, the field in this structure shall contain the binary equivalent. The Drive supports only 00h to 63h.

6.32.3.8 Data Form

Table 551 defines the data form byte.

Table 551 — Data Form Byte

7	6	5	4	3	2	1	0
Data Form of Sub-channel		Data Form of Main Data					

6.32.3.9 SCMS (Serial Copy Management System)

Bit 7 of data form of 1 indicates that Copy bit of CONTROL field alternates for Serial Copy Management System (see Table 552). The other 7 bits (Reserved) are zero. This bit is effective if Copy bit of the Control Code is zero.

Table 552 — SCMS Byte

7	6	5	4	3	2	1	0
Alternate Copy bit	Reserved						

6.32.3.10 Data Form of Main Data

The Data Form of Main Data field specifies the format of the main data to be sent by a WRITE command to write on the disc. Currently available data formats are 1.) CD-DA, 2.) CD-ROM mode 1, 3.) CD-ROM XA, and CD-I. For Lead-in and Lead-out area data are generated automatically except if Data Form is set to 41h.

6.32.3.11 CD-DA Data Form

Table 553 defines a CD-DA Data Form for one frame.

Table 553 — CD (CD-DA)

Data Form	Data of One Frame	Data Size
00h	2 352	2 352
01h	2 352	0

The CD-DA data format, Table 554, is as follows;

Table 554 — CD-DA Data format (1 Sample)

Bit	7	6	5	4	3	2	1	0
Byte								
n*4+0 (L Ch)	L7	L6	L5	L4	L3	L2	L1	L0
n*4+1 (L Ch)	L15	L14	L13	L12	L11	L10	L9	L8
n*4+2 (R Ch)	R7	R6	R5	R4	R3	R2	R1	R0
n*4+3 (R Ch)	R15	R14	R13	R12	R11	R10	R9	R8

n = 0,1, - 587

1 Second = 75 Frames

1 Frame = 588 Samples

1 Sample = 4 bytes (16 bits L, RCh)

6.32.3.12 CD-ROM mode 1 Form

Table 555 defines the form for CD-ROM mode 1.

Table 555 — CD-ROM mode 1

Data Form	Sync/ Header	Data of One Frame	EDC/ECC Area	Data Size
10h	16 ²	2 048 ¹	288 ²	2 048
11h	16 ³	2 048 ¹	288 ³	2 352
12h	16 ²	2 048 ³	288 ²	2 048
13h	16 ³	2 048 ³	288 ³	2 352
14h	16 ²	2 048 ²	288 ²	0

6.32.3.13 CD-ROM XA, CD-I Form

Table 556 defines the form for CD-ROM XA, CD-I.

Table 556 — CD-ROM XA, CD-I

Data Form		Sync/ Header	Sub Header	Data of One Frame	EDC/ECC Area	Data Size
20h	Form 1	16 ²	8 ¹	2 048 ¹	280 ³	2 336
	Form 2	16 ²	8 ¹	2 324 ¹	4 ³	2 336
21h	Form 1	16 ³	8 ¹	2 048 ¹	280 ³	2 352
	Form 2	16 ³	8 ¹	2 324 ¹	4 ³	2 352
22h	Form 1	16 ²	8 ¹	2 048 ³	280 ³	2 336
	Form 2	16 ²	8 ¹	2 324 ³	4 ³	2 336
23h	Form 1	16 ³	8 ¹	2 048 ³	280 ³	2 352
	Form 2	16 ³	8 ¹	2 324 ³	4 ³	2 352
24h	Form 1	NA	NA	NA	NA	NA
	Form 2	16 ²	8 ²	2 324 ²	4 ²	0

Reserved Area: The Reserved Area contains 4 bytes that are reserved for quality control during the disc production process. In case of Generate Zero, the Drive generates zero data of 4 bytes for this area.

6.32.3.14 CD-ROM mode 2

Table 557 defines the form for CD-ROM mode 2.

Table 557 — CD-ROM Mode 2

Data Form	Sync/ Header	Data of One Frame	Data Size
30h	16 ²	2 336 ¹	2 336
31h	16 ³	2 336 ¹	2 352
32h	16 ²	2 336 ³	2 336
33h	16 ³	2 336 ³	2 352
34h	16 ²	2 336 ²	0

For all forms:

1. Read Buffer: The data is sent by the Host.
2. Generate Data: The Drive generates the data in this area. The Host should not send the data for this area. All sectors in the program area shall have an associated write, even if all data for the sector is to be generated by the Drive. Zero bytes shall be transferred for such sectors.
3. Ignore Buffer: The Drive receives the data for this area from the Host with Write command. However, the Drive ignores the data and generates data for this area.

6.32.3.15 Data Form of Sub-channel

The DATA FORM OF SUB-CHANNEL (Table 558) field specifies the format of the Sub-channel data stored in the inner buffer by WRITE command to write on the disc.

Table 558 — Data Form of Sub-channel

Data Form		Data of One Frame				Data Size
Bit 7	Bit 6					
0	0	96 *1				0
0	1	96 *2				96
1	0	Reserved				
1	1	24 Pack ³	24 Pack ³	24 Pack ³	24 Pack ³	96

1. Generate zero data
2. RAW Data
3. PACK DATA, Host sends packed data. The Drive writes R-W. The Drive calculates and overwrites ECC, and performs Interleaving for each PACK.

When this Data Form of Sub-channel is selected, along with 01h Data Form of Main Data, this indicates that there is an attempt to write Raw P-W Sub-channel data in the Lead-in. Absolute Time field should be set with the start address of the Lead-in, that may be read via a READ TRACK INFORMATION command for track 0. In this case, the Data Block Type of the Write Parameters Page should be set to 2, 3, or 4.

The Sub-channel data is placed at the end of each Frame of main data. Figure 51 shows the relationship of Main Data and Sub-channel data.

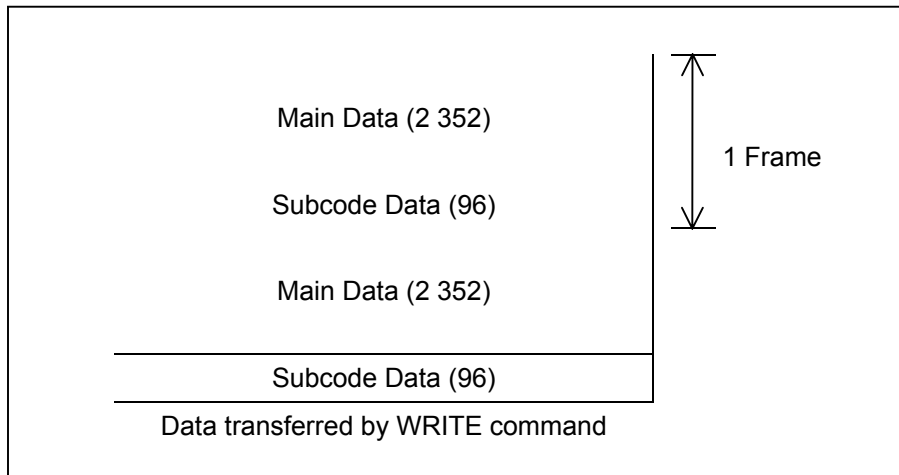

Figure 127 — Location of Sub-channel Data

The P and Q Sub-channel information contained within the Sub-code Data shall be ignored. The P and Q Sub-channel information is generated by the Drive and based on the content of the cue sheet.

6.32.3.16 Absolute Time

The time shown at Min, Sec, and Frame gives the changing point of the CONTROL, TNO, X, DATA FORM or SCMS field. These values are given in absolute time scale.

6.32.3.17 Session Format

The Session Format is used for the identification of the type of disc. Refer to Table 491.

6.32.3.18 Pre-gap

If a Data track is preceded by a different mode of track (such as an audio track) or if the mode number of CD-ROM changes, this Data track starts with an extended pre-gap. A pre-gap is placed at the head of a Data track, also is belonging to the Data track. A pre-gap does not contain actual user data. The pre-gap is encoded as "pause."

An extended pre-gap is divided into two parts. The first part of the extended pre-gap has a minimum 1 second of data, and it is encoded according to the data structure of previous track. The second part has a minimum 2 seconds data, and this data track is encoded according to the same data structure as the other parts.

6.32.3.19 Post-gap

If a Data track is followed by another kind of track (such as an audio track), this Data track ends with a post-gap. A post-gap is placed at the end of a Data track, and is part of the Data Track. A post-gap does not contain actual user data. The minimum length of post-gap is 2 seconds. The Drive does not perform any action for a Post-gap.

6.32.3.20 Media Catalog Number

Table 559, Catalog Number, indicates the catalog number of a disc. The number uses UPC/EAN-code (BAR coding). If no catalog number is used, it shall be omitted. The format is as follows;

Table 559 — Media Catalog Number (N1..N13)

CTL/ ADR	Catalog Number						
Byte 0	Byte 1	Byte 2	Byte 3	Byte 4	Byte 5	Byte 6	Byte 7
02h	N1	N2	N3	N4	N5	N6	N7
02h	N8	N9	N10	N11	N12	N13	00h
The format of the data recorded in the Sub-channel area is not identical to that specified in the Write Parameter Mode Page.							

N1-N13 Catalog Number

CTL: 4 bits are zero.

ADR: 0010b

Catalog Number: ASCII 13 BYTES

6.32.3.21 ISRC

Table 560, ISRC (International Standard Recording Code), is a code that is given to CD-DA tracks. If no ISRC is used, it shall be omitted. If a track has no ISRC, it is not written in the Cue Sheet.

Table 560 — ISRC (I1..I12)

CTL/ ADR	ISRC(International Standard Recording Code)							
	byte 0	byte 1	byte 2	byte 3	byte 4	byte 5	byte 6	byte 7
x3h	TNO	I1	I2	I3	I4	I5	I6	I6
x3h	TNO	I7	I8	I9	I10	I11	I12	I12

Note 26. The format of the data recorded in the Sub-channel area is not identical to that specified in the Write Parameter Mode Page.

CTL: 4 bits of Control code are the same as that of disc location of the specified track

ADR: 0011b

TNO: Track number in HEX.

12 letters ISRC (On the Cue Sheet, I1-I12 shall be described by valid ASCII characters. See Table 560 for valid codes.

I1-I2: Country Code

I3-I5: Owner Code

I6-I7: Year of recording

I8-I12: Serial Number

6.32.4 Timeouts

The SEND CUE SHEET command belongs to timeout group 1. If the command is terminated with CHECK CONDITION status due to a timeout, sense bytes SK/ASC/ASCQ shall be set to UNIT ATTENTION/INSUFFICIENT TIME FOR OPERATION.

6.32.5 Error Reporting

Recommended error reporting for the SEND CUE SHEET command is defined in Table 561.

Table 561 — Recommended errors for SEND CUE SHEET Command

Error	Reference
Unit Attention conditions	Table F.1
CDB or parameter list validation errors	Table F.2

6.33 SEND DISC STRUCTURE Command

6.33.1 Introduction

The SEND DISC STRUCTURE command provides a means for the Host to transfer DISC STRUCTURE data to the Drive.

Table 562 shows the Features associated with the SEND DISC STRUCTURE command.

Table 562 — Features Associated with the SEND DISC STRUCTURE Command

Feature Number	Feature Name	Command Requirement
0004h	Write Protect	Format C0h, when SPWP is set to one.
002Ah	DVD+RW	Format 05h and 30h (when Write bit in Feature Descriptor is set to one)
002Bh	DVD+R	Format 05h (when Write bit in Feature Descriptor is set to one)
002Fh	DVD-R/-RW	Mandatory
003Bh	DVD+RW Double Layer	Format 20h (when Write bit in Feature Descriptor is set to one)
0051h	HD DVD Write	Format = 0Fh
010Ah	DCB	Mandatory when writable DCBs supported

6.33.2 The CDB and Its Parameters

6.33.2.1 The CDB

The SEND DISC STRUCTURE CDB is shown in Table 563.

Table 563 — SEND DISC STRUCTURE CDB

Bit	7	6	5	4	3	2	1	0
Byte								
0	Operation Code (BFh)							
1	Reserved				Media Type			
2	Reserved							
3	Reserved							
4	Reserved							
5	Reserved							
6	Reserved							
7	Format							
8	(MSB) Parameter List Length (LSB)							
9								
10	Reserved							
11	Control							

6.33.2.2 Media Type

The Media Type field identifies the Media Type to which this command is directed. Media Types as listed in Table 564.

Table 564 — Media Types

Media Type	Associated Discs
0h	DVD and HD DVD
1h	BD
All others	Reserved

6.33.2.3 Format

The Format field indicates the type of information to be sent to the Drive. If the currently mounted media is not supported by the Drive, the command shall be terminated with CHECK CONDITION status and SK/ASC/ASCQ values are set to ILLEGAL REQUEST/ CANNOT READ MEDIUM – INCOMPATIBLE FORMAT. If the Drive/media combination does not support the specified format code, the command shall be terminated with CHECK CONDITION status and SK/ASC/ASCQ values are set to ILLEGAL REQUEST/INVALID FIELD IN CDB. Format field definitions are specific to media type. The Format field values defined for DVD and HD DVD are shown in Table 565.

Table 565 — Format Field Definition for Media Type = 0 (DVD and HD DVD)

Format	Data	Description
00h – 03h	Reserved	
04h	User Specific Data	Send User Specific Data to the RMD cache
05h	Copyright Management	Send data to CPR_MAI in data area cache. (CPM, CGMS,
06h – 0Eh	Reserved	
0Fh	Timestamp	Send Timestamp data to the Drive
10h – 1Fh	Reserved	
20h	Layer Boundary Information	Send capacity of L0
21h	Shifted Middle Area	Send start logical block address of Shifted Middle Area on L0
22h	Jump Interval size	Send Jump Interval size of Regular Interval Layer Jump recording
23h	Manual Layer Jump Address	Send logical block address for Layer Jump on L0
24h	Remapping Address	Send logical block address for remapping Anchor Point
25h – 2Fh	Reserved	
30h	Disc Control Block	Send a Disc Control Block
31h – BFh	Reserved	
C0h	Write Protection	Send PWP status
C1h – FFh	Reserved	

The Format field values defined for BD are shown in Table 566.

Table 566 — Format Field Definition for Media Type = 1 (BD)

Format Code	Data	Description
00h – 0Eh	Reserved	
0Fh	Timestamp	Send Timestamp data to the Drive
30h	PAC	Send PAC data
31h – FFh	Reserved	

6.33.2.4 Parameter List Length

The Parameter List Length field specifies the length in bytes of the DISC STRUCTURE data to be transferred from the Host to the Drive after the CDB is transferred. A Structure Data Length field of zero indicates that no data shall be transferred. This condition shall not be considered an error.

6.33.3 Command Processing

6.33.3.1 General

If the Drive is unable to write to the currently mounted medium, error reporting should follow the guidelines according to 4.1.6.3.

6.33.3.2 SEND DISC INFORMATION for DVD and HD DVD (Media Type = 0h)

6.33.3.2.1 Format = 04h: User Specific Data

Table 567 defines the response data format for User Specific Data, Format code 04h

Table 567 — SEND DISC STRUCTURE Parameter List (Format = 04h)

Bit	7	6	5	4	3	2	1	0	
Byte									
0	(MSB) DISC STRUCTURE Data Length								
1								(LSB)	
2	Reserved								
3	Reserved								
DVD-R User Specific Data									
0	(MSB) User Specific Data								
...									
2047								(LSB)	

The DISC STRUCTURE Data Length field specifies the length in bytes of the User Specific Data to follow. A DVD Structure Data Length field of zero indicates that no User Specific Data shall be transferred. This condition shall not be considered an error.

The User Specific Data field contains user specific data. This data shall be used to specify the RMD Field 2, and when writing Lead-in the contents of this field shall also be written in Disc manufacturing information field of Lead-in or Border-in.

6.33.3.2.2 Format = 05h: Copyright Management Information

Table 568 describes the response data format for Copyright Management Information, format code 05h.

Table 568 — SEND DISC STRUCTURE Parameter List (Format = 05h)

Bit Byte	7	6	5	4	3	2	1	0
0	(MSB) DISC STRUCTURE Data Length							
1	(LSB)							
2	Reserved							
3	Reserved							
Copyright Management Information in data area								
0	CPR_MAI							
1	Reserved							
2	Reserved							
3	Reserved							

The DISC STRUCTURE Data Length field specifies the length in bytes of the Copyright Management data to follow. A DVD Structure Data Length field of zero indicates that no Copyright Management data shall be transferred. This condition shall not be considered an error.

The definition of the CPR_MAI field depends on the mounted media. The CPR_MAI field definition is shown in Table 569.

Table 569 — CPR_MAI Field Definitions

Bit Media	7	6	5	4	3	2	1	0
DVD-R, ver 1.0 DVD-RW, ver 1.0	CPM	Resvd	CGMS		Reserved			
DVD-RAM Ver.1.0/2.1 DVD-R for Authoring Ver .2.0	Reserved							
DVD-R for General, ver 2.0, DVD-RW, ver 1.1 and DVD+RW	Reserved				ADP_TY		Reserved	

If the CPM bit is set to 0, shall indicate that this sector contains no copyrighted material. If the CPM bit is set to 1, shall indicate that this sector contains copyrighted material. If this structure is not sent, the default value of the CPM bit shall be 0.

When the CPM bit is set to 0, the CGMS field shall be set to 00b.

When the CPM bit is set to 1, the CGMS field shall be set as shown in Table 570.

Table 570 — CGMS Field Values

CGMS	Definition
00b	Copying is permitted without restriction
01b	Reserved
10b	One generation of copies may be made
11b	No copying is permitted

The identical CGMS value of CPR_MAI in data area shall match with this format following write operation.

The ADP_TY field is defined for DVD-RW Ver. 1.1, DVD-R for General Ver. 2.0, and DVD+RW media. If the sector contains materials defined in DVD Specifications for Read-Only Disc Part 3 VIDEO SPECIFICATIONS, the ADP_TY field shall be set to 01b. If the sector contains no such data, ADP_TY field shall be set to 00b. All other values of ADP_TY are reserved.

Note 27. Due to the nature of the recording method for DVD-R/-RW media, a value of each field may vary during first and last 16 sectors of each recording extent.

6.33.3.2.3 Format = 0Fh: Timestamp

The format of Timestamp field is structured as shown in Table 571. The time should be current UTC (Universal Coordinated Time) 24 hour clock.

Table 571 — SEND DISC STRUCTURE Parameter List (Format = 0Fh)

Bit Byte	7	6	5	4	3	2	1	0
0	(MSB) DISC STRUCTURE Data Length							(LSB)
1								(LSB)
2	Reserved							
3	Reserved							
Timestamp Data								
0	Reserved							
1	Reserved							
2	Reserved							
3	Reserved							
4	(MSB) Year							
5								
6								
7								(LSB)
8	(MSB) Month							
9								(LSB)
10	(MSB) Day							
11								(LSB)
12	(MSB) Hour							
13								(LSB)
14	(MSB) Minute							
15								(LSB)
16	(MSB) Second							
17								(LSB)

The DISC STRUCTURE Data Length field specifies the length in bytes of the Timestamp Data to follow. A DVD Structure Data Length field of zero indicates that no Timestamp Data shall be transferred. This condition shall not be considered an error.

The Year field shall specify the year that coded as ASCII in the range "0001" to "9999".

The Month field shall specify the month of the year that coded as ASCII in the range "01" to "12".

The Day field shall specify the day of the month that coded as ASCII in the range "01" to "31".

The Hour field shall specify the hour of the day that coded as ASCII in the range "00" to "23".

The Minute field shall specify the minute of the hour that coded as ASCII in the range "00" to "59".

The Second field shall specify the second of the minute that coded as ASCII in the range "00" to "59".

Note 28. The format of SEND DISC STRUCTURE parameter list for media type = 0h is the same as the format of SEND DISC STRUCTURE parameter list for media type = 1h.

6.33.3.2.4 Format = 20h: Layer Boundary Information

If Format 20h is not implemented for the currently mounted media, the command shall be terminated with CHECK CONDITION status and sense bytes SK/ASC/ASCQ shall be set to ILLEGAL REQUEST/INVALID FIELD IN CDB.

Table 572 — SEND DISC STRUCTURE Parameter List (Format = 20h)

Bit Byte	7	6	5	4	3	2	1	0
0	(MSB) Structure Data Length							
1	(LSB)							
2	Reserved							
3	Reserved							
Layer Boundary Information								
0 - 3	Reserved							
4	(MSB) L0 Data Area Capacity							
5								
6								
7								

The Structure Data Length field specifies the number of bytes that follow the Structure Data Length field.

The L0 Data Area Capacity field shall specify the Data Area capacity on L0 in logical block. The value shall be greater than zero. The last LBA of Data Area on L0 is L0 Data Area Capacity - 1.

If the value of L0 Data Area Capacity field is not an integral multiple of 16, the value shall be rounded up to the next integral multiple of 16. If the rounded L0 Data Area Capacity value is greater than available capacity on L0, the command shall be terminated with CHECK CONDITION status and sense bytes SK/ASC/ASCQ shall be set to ILLEGAL REQUEST/INVALID FIELD IN PARAMETER BLOCK. If Data Area capacity has already been established by a previous SEND DISC STRUCTURE command with Format Code value of 20h, the command shall be terminated with CHECK CONDITION status and sense bytes SK/ASC/ASCQ shall be set to ILLEGAL REQUEST/INVALID FIELD IN PARAMETER BLOCK.

6.33.3.2.5 Format = 21h: Shifted Middle Area Start Address

Format 21h permits the Host to set the start logical block address of Shifted Middle Area on L0.

If Format 21h is not implemented for the currently mounted media, the command shall be terminated with CHECK CONDITION status and sense bytes SK/ASC/ASCQ shall be set to ILLEGAL REQUEST/INVALID FIELD IN CDB.

Table 573 — SEND DISC STRUCTURE Parameter List (Format = 21h)

Bit Byte	7	6	5	4	3	2	1	0
0	(MSB) Structure Data Length							
1	(LSB)							
2	Reserved							
3	Reserved							
Shifted Middle Area Information								
0 - 3	Reserved							
4	(MSB) Shifted Middle Area Start Address							
5								
6								
7								

The Structure Data Length field specifies the number of bytes that follow the Structure Data Length field.

The Shifted Middle Area Start Address field shall specify the start Logical Block Address of the Shifted Middle Area on L0. This value shall be:

1. A multiple of the Blocking factor,
2. located in the unrecorded area of the Invisible/Incomplete RZone,
3. greater than or equal to the LBA on L0 that is corresponding to the end LBA on L1, and
4. less than or equal to the end LBA on L0 - AC10h only if the Drive allocates the flexible ODTA (Outer Disc Testing Area). When the value is set larger than the end LBA on L0 - AC10h, no flexible ODTA is allocated.

Once this value has been set, the value is not changeable. The outer radius area beyond the Shifted Middle Area becomes unusable for user data. Therefore the number of free blocks is decreased. If the specified value is not correct or has already been set, this command shall be terminated with CHECK CONDITION Status and sense bytes SK/ASC/ASCQ shall be set to ILLEGAL REQUEST/INVALID FIELD IN PARAMETER LIST.

6.33.3.2.6 Format = 22h: Jump Interval Size

Format 22h permits the Host to set the Jump Interval size for the Regular Interval Layer Jump recording of the Invisible Rzone.

Table 574 — SEND DISC STRUCTURE Parameter List (Format = 22h)

Bit Byte	7	6	5	4	3	2	1	0
0	(MSB) Structure Data Length							
1	(LSB)							
2	Reserved							
3	Reserved							
Jump Interval Size								
0 - 3	Reserved							
4	(MSB) Jump Interval Size (LSB)							
5								
6								
7								

The Structure Data Length field specifies the number of bytes that follow the Structure Data Length field.

The Jump Interval size field shall specify the Jump Interval size of the Regular Interval Layer Jump recording of the Invisible RZone by number of sectors. The number of sectors shall be multiple of Blocking Factor specified by the Fixed Packet Size/ Blocking Factor field (6.26.3.16) of the Track Information Block (Table 491). If the value is not a multiple of Blocking Factor, the command shall be terminated with CHECK CONDITION status and sense bytes SK/ASC/ASCQ shall be set to ILLEGAL REQUEST/INVALID FIELD IN PARAMETER LIST.

6.33.3.2.7 Format = 23h: Manual Layer Jump Address

Format 23h permits the Host to set the Layer Jump Address.

Table 575 — SEND DISC STRUCTURE Parameter List (Format = 23h)

Bit	7	6	5	4	3	2	1	0	
Byte									
0	(MSB) Structure Data Length								
1								(LSB)	
2	Reserved								
3	Reserved								
Manual Layer Jump Address									
0 - 3	Reserved								
4	(MSB)								
5	Layer Jump Logical Block Address								
6									
7									(LSB)

The Structure Data Length field specifies the number of bytes that follow the Structure Data Length field.

The Layer Jump Logical Block Address field shall specify the logical block address that cause Layer jump of NWA from L0 to Layer 1 after the sector of the logical block address is written. The logical block address shall be the last sector number of an ECC block.

If the corresponding address on Layer 1 of the Layer Jump Address on L0 is not available for recording (i.e., Out of range of the RZone) or has been set, the command shall be terminated with CHECK CONDITION status and sense bytes SK/ASC/ASCQ shall be set to ILLEGAL REQUEST/INVALID FIELD IN PARAMETER LIST.

6.33.3.2.8 Format = 24h: Remapping Address

Format 24h permits the Host to define remapping areas for up to 4 anchor points.

Table 576 — SEND DISC STRUCTURE Parameter List (Format = 24h)

Bit	7	6	5	4	3	2	1	0
Byte								
0	(MSB) Structure Data Length							
1	(LSB)							
2	Reserved							
3	Reserved							
Remapping Address								
0	(MSB) Anchor Point Number							
1	(LSB)							
2	Reserved							
3	Reserved							
4	(MSB) Remapping Address							
5								
6								
7	(LSB)							

The Structure Data Length field specifies the number of bytes that follow the Structure Data Length field.

The Anchor Point Number field shall specify the number of Anchor Point that is reassigned. In the case of DVD-R Dual Layer disc, the number shall be 1, 2, 3, or 4.

The Remapping Address field shall specify the LBA that is used to reassign the Anchor Point block specified by Anchor Point Number field. The LBA shall be a multiple of Blocking Factor as specified by the Fixed Packet Size/ Blocking Factor field (6.26.3.16) of the Track Information Block (Table 491). If the value is not a multiple of Blocking Factor, the command shall be terminated with CHECK CONDITION status and sense bytes SK/ASC/ASCQ shall be set to ILLEGAL REQUEST/INVALID FIELD IN PARAMETER LIST. The Drive shall check that the ECC block specified by Anchor Point Number and Remapping Address fields has been written. If the ECC block is not written, this command shall be terminated with CHECK CONDITION status and sense bytes SK/ASC/ASCQ shall be set to ILLEGAL REQUEST/INVALID FIELD IN PARAMETER LIST.

Note 29. The Drive needs not check the validity of the Remapping Address. Even if the address specifies a Border Zone or Clearance, Drive may not report any error.

6.33.3.2.9 Format Code = 30h: Disc Control Block**6.33.3.2.9.1 General**

Disc Control Block data returned is formatted as shown in Table 577.

Table 577 — SEND DISC STRUCTURE Parameter List (Format field = 30h)

Bit	7	6	5	4	3	2	1	0
Byte								
0	(MSB) DISC STRUCTURE Data Length							(LSB)
1								
2	Reserved						Erase	
3	Reserved							
Specific Disc Control Block Information								
0 ... 32767	DCB							

The DISC STRUCTURE Data Length specifies the length in bytes of the following DISC STRUCTURE data that is available to be transferred to the Host. The DISC STRUCTURE Data Length value does not include the DISC STRUCTURE Data Length field itself.

The Erase bit, when set to zero, shall indicate that the Disc Control Block be written to the media. When set to one, it shall indicate that each Disc Control Block on the medium, with a Content Descriptor matching the one sent, shall be erased.

The Drive shall not record any DCB unknown to the Drive.

The Disc Control Block field is defined in the [DVD+Ref1] and [DVD+Ref2]. If a Disc Control Block, with fewer than 32 768 bytes is sent, the Drive shall pad the Disc Control Block with 00h bytes.

6.33.3.2.9.2 Erasing a DCB

For some DCBs, it is sufficient to include only the DVD Structure header (4 bytes) followed by the DCB content descriptor (4 bytes). For others (e.g. WDCB) the entire DCB information shall be sent.

6.33.3.2.9.3 Write Inhibit DCB

The Write Inhibit DCB (WDCB) provides the Host with the ability to control write access to the media. If the entire media is write protected, the WDCB is the only writable ECC block on the media and may be written only via the SEND DISC STRUCTURE command with format code = 30h.

Access to the WDCB may be protected by a password (see Table 428). If the WDCB is password protected, writing the WDCB is permitted only when the password field exactly matches the password field of the current WDCB. If the Host's password does not match the media password, then the command shall be terminated with CHECK CONDITION status and sense bytes SK/ASC/ASCQ shall be set to ILLEGAL REQUEST/INVALID FIELD IN PARAMETER LIST.

Table 578 shows examples of WDCB management for control of write protect status.

Table 578 — WDCB Management Examples

WDCB Status	Desired Action	Required Command Sequence
No WDCB on media	Write protect the media	Send a valid WDCB.
WDCB present on media – not password protected	Change write protect status	Send a valid WDCB with desired write protect status.
	Password protect current WDCB	Read the DCB to maintain current write protect status. Enable the password and send the WDCB with a valid password in the password field
Password protected WDCB present on media	Change write protect status	Send a valid WDCB with the desired write protect status and the correct password field.
	Change the password	Send a valid WDCB with the desired write protect status and the correct password field. Set the Erase bit in the header. Send a new WDCB with the new password enabled.

If the WDCB Password field is set to all FFh, then the disc is permanently write protected and further recording on the disc shall not be allowed. This includes formatting.

6.33.3.2.10 Format Code = C0h: Write Protection

Table 579 defines data format code C0h.

Table 579 — SEND DISC STRUCTURE Parameter List (Format Field = C0h)

Bit Byte	7	6	5	4	3	2	1	0
0	(MSB) Structure Data Length							(LSB)
1								
2	Reserved							
3	Reserved							
Write Protection Data								
4	Reserved					PWP	Reserved	
5	Reserved							
6	Reserved							
7	Reserved							

The DVD Structure Data Length field shall indicate the number of bytes following this field.

The Persistent Write Protection (PWP) bit of one indicates that the medium surface shall be set to write protected status. The PWP bit of zero indicates that the medium surface shall be set to write permitted status.

If the SEND DISC STRUCTURE command with Format Field set to C0h is sent while the currently mounted medium is DVD+RW, the command shall be terminated with CONDITION STATUS and sense bytes SK/ASC/ASCQ shall be set to ILLEGAL REQUEST/INVALID FIELD IN CDB.

6.33.3.3 SEND DISC INFORMATION for BD (Media Type = 1h)**6.33.3.3.1 Format = 0Fh: Timestamp**

The format of SEND DISC STRUCTURE parameter list for media type = 1h is the same as the format of SEND DISC STRUCTURE parameter list for media type = 0h. See 6.33.3.2.3.

6.33.3.3.2 Format Code = 30h: Send a PAC**6.33.3.3.3 General**

Physical Access Control (PAC) Clusters are provided as a structure on the disc to include additional information for interchange between interchange parties. PAC Clusters shall be recorded in the INFO1/PAC1 Area and backup copies shall be recorded in the INFO2/PAC2 Area. The format of PAC data provided by the Host is shown in Table 580.

Table 580 — Physical Access Control Send Parameter List

Bit Byte	7	6	5	4	3	2	1	0
0	(MSB) Data Structure Length = N+2							(LSB)
1								
2	Reserved						Erase	
3	Reserved							
PAC Structure								
0	PAC Header							
...								
383								
384	PAC Specific Information							
...								
N-1								

If the Erase bit is set to zero, the remainder of the structure contains the PAC Cluster content that should be written to the media.

If the Erase bit is set to one, each occurrence of a PAC with the PAC ID matching the PAC ID in the PAC Header in the parameter list shall be erased (on BD-RE) or invalidated (on BD-R). The PAC information following the disc structure header shall be ignored.

The Drive shall neither record nor erase any PAC that is unknown to the Drive.

The value for N (PAC structure size) is at least 384 and at most 63488.

6.33.3.3.4 DWP PAC

The Disc Write Protect (DWP) PAC Cluster is used to protect a disc against unintended write actions or write actions by unauthorized persons. For the case where the disc is protected against write actions by unauthorized persons, a password **may** be included. Recognition and reading the DWP PAC is mandatory. Writing the DWP PAC is optional. If the Drive does not support writing the DWP PAC, the command shall be terminated with CHECK CONDITION status and sense bytes SK/ASC/ASCQ shall be set to ILLEGAL REQUEST/INVALID FIELD IN CDB..

The format of the Disc Write Protect PAC structure is shown Table 581.

Table 581 — DWP PAC

Bit Byte	7	6	5	4	3	2	1	0
0	(MSB) Data Structure Length = 430							
1	(LSB)							
2	Reserved						VWE	Erase
3	Reserved							
DWP PAC Data								
0	DWP PAC Header							
1								
...								
383								
384	Known PAC Entire_Disc_Flags							
385	Reserved							
386	Reserved							
387	Reserved							
388	Write Protect Control Byte (see Table 60)							
389 - 395	Reserved							
396 - 427	Write Protect Password							

The VWE (Virtual Write Enable) bit is used to enable or disable writing to a virtually write protected disc. When VWE is set to 1, the Host is requesting the ability to write on a virtually write protected disc. This is a temporary write capability, a media change or drive reset will cause the system to return to a write protected state. When VWE is set to 0, it indicates that the host is rescinding temporary write ability.

If the Erase bit is defined as in the general case specified in 6.33.3.3.3.

If there is a current valid Write Protect Password on the disc, then the Drive shall process this request only if the Write Protect Password field matches the Password on the disc.

The length of a DWP PAC is 428 bytes.

6.33.4 Timeouts

The SEND DISC STRUCTURE command belongs to timeout group 1. If the command is terminated with CHECK CONDITION status due to a timeout, sense bytes SK/ASC/ASCQ shall be set to UNIT ATTENTION/INSUFFICIENT TIME FOR OPERATION.

6.33.5 Error Reporting

Recommended error reporting for the SEND DISC STRUCTURE command is defined in Table 582.

Table 582 — Recommended errors for SEND DISC STRUCTURE Command

Error	Reference
Unit Attention conditions	Table F.1
CDB or parameter list validation errors	Table F.2
Readiness errors	Table F.3
Protocol errors	Table F.4
General media access errors	Table F.5
Write errors	Table F.7
Hardware failures	Table F.8

6.34 SEND KEY Command

6.34.1 Introduction

The SEND KEY command provides data necessary for authentication and for generating a Bus Key for protected data transfers between the Host and Drive.

This command, in conjunction with REPORT KEY command, is intended to perform authentication for Drives that conform to a specified Content Protection scheme and to generate a Bus Key as the result of authentication.

Table 583 shows the Features associated with the SEND KEY command.

Table 583 — Features Associated with the SEND KEY Command

Feature Number	Feature Name	Command Requirement
0106h	DVD CSS	Mandatory
010Bh	DVD CPRM	Mandatory
010Dh	AACS	Mandatory
0110h	VCPS	Mandatory

6.34.2 The CDB and Its Parameters

6.34.2.1 The CDB

The SEND KEY CDB is shown in Table 584.

Table 584 — SEND KEY CDB

Bit Byte	7	6	5	4	3	2	1	0
0	Operation Code (A3h)							
1	Reserved							
2	Reserved							
3	Reserved							
4	Reserved							
5	Reserved							
6	Reserved/VCPS Function							
7	Key Class							
8	(MSB) Parameter List Length (LSB)							
9								
10	AGID		Key Format					
11	Control							

6.34.2.2 Reserved/VCPS Function

This field contains a VCPS Function code when the Key Class value is 20h (VCPS). For all other Key Classes, this field is reserved.

6.34.2.3 Key Class

The Key Class field shall identify the type of authentication conversation according to Table 585.

Table 585 — Key Class

Key Class	Authentication Type
00h	DVD CSS/CPPM or CPRM
01h	ReWritable Security Service – AS-MO
02h	AACS
03h – 1Fh	Reserved
20h	VCPS
02h – FFh	Reserved

6.34.2.4 Parameter List Length

The Parameter List Length field specifies the length in bytes of the SEND KEY parameter list that shall be transferred from the Host to the Drive. A Parameter List Length of zero indicates that no data shall be transferred. This condition shall not be considered an error. If the Parameter List Length results in the truncation of any SEND KEY parameter list, the Drive shall terminate the command with CHECK CONDITION status and set sense bytes SK/ASC/ASCQ to ILLEGAL REQUEST/PARAMETER LIST LENGTH ERROR.

6.34.2.5 AGID

The AGID field is used to control simultaneous key exchange sequences. The AGID specified in subsequent Key Exchange commands shall match a currently active AGID.

Note 30. Drives that support more than one Key Format for requesting an AGID do not necessarily support simultaneous key exchange sequences.

6.34.2.6 Key Format

The Key Format field indicates the types of information that is to be sent to the Drive. The definition for specific Key Format fields is dependent upon the Key Class.

6.34.3 Command Processing**6.34.3.1 Key Class 00h, DVD CSS/CPPM or CPRM****6.34.3.1.1 General**

The Key Format field (Table 586) indicates the type of information that is to be sent to the Host.

Table 586 — Key Format Code definitions for SEND KEY Command

Key Format	Sent Data	Description	AGID Use
000001b	Challenge Key	Accepts a Challenge Key	Valid AGID required
000011b	KEY2	Accepts a KEY2	
000110b	RPC Structure	Set Region	Reserved & Ignored
111111b	None	Invalidate Specified AGID	Typically Valid AGID
All other values	Reserved		

6.34.3.1.2 Key Format = 000001b, Challenge

The Challenge Key (Table 587) is sent to the DVD Drive to get corresponding KEY1 from the DVD Drive to interrogate conformity with DVD Content Protection scheme.

Table 587 — SEND KEY Parameter List (KEY Format field =000001b)

Bit Byte	7	6	5	4	3	2	1	0
0	(MSB) SEND KEY Parameter List Length (0Eh) (LSB)							
1								
2	Reserved							
3	Reserved							
Challenge Key Value								
0	(MSB) Challenge Key Value (LSB)							
:								
9								
10	Reserved							
11	Reserved							

6.34.3.1.3 Key Format = 000011b, Response

The KEY2 (Table 588), generated external to the DVD Drive, is sent to the DVD Drive to determine its conformity with DVD Copy Protection scheme. The KEY 2 value shall be used for the second input to generate a Bus Key in the DVD Drive.

When the KEY2 value sent does not conform to the DVD Copy Protection scheme, this command shall be terminated with a CHECK CONDITION status and SK/ASC/ASCQ values are set to ILLEGAL REQUEST/COPY PROTECTION KEY EXCHANGE FAILURE – AUTHENTICATION FAILURE.

If the SEND KEY command with KEY Format = 000011b terminates with CHECK CONDITION status, the retry of authentication shall be performed from the beginning.

Table 588 — SEND KEY Parameter List (KEY Format field =000011b)

Bit	7	6	5	4	3	2	1	0	
Byte									
0	(MSB) SEND KEY Parameter List Length (0Ah)								
1									(LSB)
2	Reserved								
3	Reserved								
KEY2									
0	(MSB)								
:									
4	KEY2 Value								(LSB)
5	Reserved								
6	Reserved								
7	Reserved								

6.34.3.1.4 Key Format = 000110b, RPC Structure

The Preferred Drive Regional Code (Table 589) is sent to the DVD Drive to make the Drive regionalized. The Preferred Drive Region Code specifies a single region in which the disc may be played. Each bit represents one of eight regions. If a bit is cleared in this field, the disc may be played in the corresponding region. If a bit is set in this field, the disc is unable to be played in the corresponding region. Exactly one bit of the Preferred Drive Region Code shall contain a zero.

If the Drive does not support setting of the Region, or the Region is no longer changeable, then this command shall be terminated with CHECK CONDITION status and SK/ASC/ASCQ values shall be set to DRIVE REGION MUST BE PERMANENT/REGION RESET COUNT ERROR.

Table 589 — SEND KEY Parameter List (KEY Format field =000110b)

Bit	7	6	5	4	3	2	1	0	
Byte									
0	(MSB) SEND KEY Parameter List Length (06h)								
1								(LSB)	
2	Reserved								
3	Reserved								
RPC Structure									
0	Preferred Drive Region Code								
1	Reserved								
2	Reserved								
3	Reserved								

6.34.3.1.5 Invalidate Authentication Grant ID (Key Format = 111111b)

This KEY Format requests the Drive invalidate the specified Authentication Grant ID. The AGID is specified in the AGID field of the CDB. Invalidating an invalid AGID shall not be considered an error.

No further conversation is allowed over this AGID until it is assigned again with a new REPORT KEY command requesting an AGID. No data is returned by the Drive.

6.34.3.2 AACS

The SEND KEY command with Key Class = 02h is used for AACS authentication process. The SEND KEY command with Key Class = 02h provides data necessary for authentication and for generating a Bus Key and ends the authentication process.

Table 590 — Key Format definitions for SEND KEY command (Key Class = 02h)

Key Format	Send Data	Description	AGID Use
000001h	Host Certificate Challenge	Send a Host Certificate Challenge to Drive	Valid AGID required
000010h	Host Key	Send a Host Key to Drive	
111111h	None	Invalidate Specified AGID for AACS.	Typically Valid AGID
All other value	Reserved		

6.34.3.2.1 Host Certificate Challenge (KEY Format = 000001b)

The Host Certificate Challenge format (Table 591) provides data to the Drive to be used to verify legitimacy of the host.

Table 591 — SEND KEY Parameter List (With KEY Format = 000001b, Key Class = 02h)

Bit	7	6	5	4	3	2	1	0	
Byte									
0	(MSB) SEND KEY Parameter List Length (72h)								
1								(LSB)	
2	Reserved								
3	Reserved								
Host Certificate Challenge									
0	(MSB)								
...	Host Certificate Challenge Data								
111								(LSB)	

The SEND KEY Parameter List Length field specifies the length in bytes of the following SEND KEY parameter list to be transferred to the Drive. The SEND KEY Parameter List Length value does not include the SEND KEY Parameter List Length field itself.

The Host Certificate Challenge Data is sent to the Drive to be used by the Drive to verify legitimacy of the host. When the Host Certificate Challenge Data is determined to be not legitimate or is revoked, the command shall be terminated with CHECK CONDITION status and sense bytes SK/ASC/ASCQ shall be set to ILLEGAL REQUEST/COPY PROTECTION KEY EXCHANGE FAILURE – AUTHENTICATION FAILURE.

6.34.3.2.2 Host Key (KEY Format = 000010b)

The Host Key format (Table 592) permits the Host to send key information that is to be used by the Drive to generate the Bus Key.

Table 592 — SEND KEY Parameter List (With KEY Format = 000010b, Key Class = 02h)

Bit	7	6	5	4	3	2	1	0	
Byte									
0	(MSB) SEND KEY Parameter List Length (52h)								
1								(LSB)	
2	Reserved								
3	Reserved								
Host Key									
0	(MSB)								
...	Host Key Data								
79								(LSB)	

The SEND KEY Parameter List Length field specifies the length in bytes of the following SEND KEY parameter list to be transferred to the Drive. The SEND KEY Parameter List Length value does not include the SEND KEY Parameter List Length field itself.

The Host Key Data is sent to the Drive to be used, together with the Drive Key Data, to generate the Bus Key.

6.34.3.2.3 Invalidate Authentication Grant ID for AACS (Key Format = 111111b)

This KEY Format requests the Drive invalidate the specified Authentication Grant ID for AACS. The AGID is specified in the AGID field of the CDB. Invalidating an invalid AGID shall not be considered an error.

No further conversation is allowed over this AGID until it is assigned again with a new REPORT KEY command requesting an AGID. No data is returned by the Drive.

6.34.3.3 VCPS**6.34.3.3.1 General**

The VCPS Function code specifies the VCPS function to be performed. VCPS Functions are listed in Table 524. If the VCPS Function code is a reserved value, the command shall be terminated with CHECK CONDITION status and sense bytes SK/ASC/ASCQ values shall be set to ILLEGAL REQUEST/INVALID PARAMETER IN CDB.

Table 593 — VCPS Functions for SEND KEY

VCPS Function Code	VCPS Function Code
00h	Reserved
01h	Authorization Key
02h	Key Contribution
03-FFh	Reserved

6.34.3.3.2 VCPS Function Code = 01h, Authorization Key

When the VCPS function code is 01h, the SEND KEY command sends the Authorization Key KA of the Drive. This function of the SEND KEY command provides the functionality of step 2 in the authentication protocol (see 4.10.4.2). The command execution shall proceed as follows:

1. If the authentication sequence has been violated, the Drive shall terminate the command with CHECK CONDITION status. In addition the Drive shall set sense bytes SK/ASC/ASCQ to ILLEGAL REQUEST/COMMAND SEQUENCE ERROR. A retry of the authentication protocol shall start from step 1.
2. Otherwise, the Drive shall accept the Authorization Key and terminate with GOOD status.

The format of the parameter data is defined in Table 594.

Table 594 — VCPS Key Class SEND KEY parameter list, Authorization Key

Bit Byte	7	6	5	4	3	2	1	0
0	Send Key Data Length (0022h)							
1								
2	Reserved							
3	Reserved							
Authorization Key Information								
0	Reserved							
...								
6								
7	Node Key Number							
8	Host's Random Number							
...								
15								
16	Authorization Key KA _x							
...								
31								

The Send Key Data Length is 34 bytes (0022h).

The Reserved field shall contain 7 bytes, each set to 00h.

The Node Key Number field is the Node Key (KN_j) from the set of Node Keys (KN_d) that the Drive shall use to obtain the Root Key (KR_{auth}) from the Authorization Key (KA_x). For this purpose, the Node Key Number field contains the bit position of the Device ID_D bit that the Application has last processed in the EKB search algorithm.

The Host's Random Number field contains a 64-bit random number.

The Authorization Key field contains KA_x that the Application has retrieved from the Application Key Block AKB that is built-in to the Application, based on the Device ID_D the Application has obtained from the Drive.

6.34.3.3.3 VCPS Function Code = 02h, Key Contribution

When the VCPS function is 02h, the SEND KEY command sends the Bus Key contribution of the Application. This function of the SEND KEY command provides the functionality in step 6 of the authentication protocol (see 4.10.4.2). The command execution shall proceed as follows:

1. If the authentication sequence has been violated, the Drive shall terminate the command with CHECK CONDITION status and set sense bytes SK/ASC/ASCQ to ILLEGAL REQUEST/COMMAND SEQUENCE ERROR. A retry of the authentication protocol shall start from step 1.
2. If the random number RD of the Drive is not equal to the random number RD that the Drive has sent to the Application in the previous REPORT KEY Contribution command, the Drive shall terminate the command with CHECK CONDITION status and set sense bytes SK/ASC/ASCQ to ILLEGAL REQUEST/COPY PROTECTION KEY EXCHANGE FAILURE — AUTHENTICATION FAILURE. A retry of the authentication protocol shall start from step 1 (see 4.10.4.2).
3. Otherwise, the Drive shall accept the Application Bus Key contribution and terminate with GOOD status.

The format of the parameter data is defined in Table 595.

Table 595 — VCPS Key Class SEND KEY parameter list, Key Contribution

Bit Byte	7	6	5	4	3	2	1	0
0	Send Key Data Length (0026h)							
1								
2	Reserved							
3	Reserved							
Key Contribution data								
0	Reserved							
...								
3								
4	Encrypted Random Numbers 2							
...								
19								
20	Encrypted Application Key Contribution							
...								
35								

The Send Key Data Length is 38 bytes (0026h).

The Reserved field contains 4 bytes, each set to 00h.

The Encrypted Random Numbers 2 field contains the random number RD of the Drive and the random number RA of the Application, encrypted using the Root Key KR_{auth} .

Encrypted Random Numbers 2 is determined by an encryption using KR_{auth} , IV2, RD, and RA, where IV2 is a 128-bit licensed constant.

The Encrypted Application Key Contribution field contains the key contribution QA of the Application, encrypted using the Root Key KR_{auth} and combined with Encrypted Random numbers 2.

6.34.4 Timeouts

The SEND KEY command belongs to timeout group 1. If the command is terminated with CHECK CONDITION status due to a timeout, sense bytes SK/ASC/ASCQ shall be set to UNIT ATTENTION/INSUFFICIENT TIME FOR OPERATION.

6.34.5 Error Reporting

Recommended error reporting for the SEND KEY command is defined in Table 596.

Table 596 — Recommended errors for SEND KEY Command

Error	Reference
Unit Attention conditions	Table F.1
CDB or parameter list validation errors	Table F.2
Readiness errors	Table F.3
General media access errors	Table F.5
Hardware failures	Table F.8

6.35 SEND OPC INFORMATION Command

6.35.1 Introduction

The SEND OPC INFORMATION command is used to specify the Optimum Power Calibration (OPC) values to the Drive for the currently mounted medium disc. This command should be used in conjunction with the READ DISC INFORMATION command (6.22).

Table 597 shows the Features associated with the SEND OPC INFORMATION command.

Table 597 — Features Associated with the SEND OPC INFORMATION Command

Feature Number	Feature Name	Command Requirement
0021h	Incremental Streaming Writable	When OPC is reported in Disc Information
002Dh	CD Track At Once	When OPC is reported in Disc Information
002Eh	CD Mastering	When OPC is reported in Disc Information
003Bh	DVD+R DL	Mandatory
0051h	HD DVD Write	When OPC is reported in Disc Information

6.35.2 The CDB and Its Parameters

6.35.2.1 The CDB

The SEND OPC INFORMATION CDB is shown in Table 598.

Table 598 — SEND OPC INFORMATION CDB

Bit	7	6	5	4	3	2	1	0	
Byte									
0	Operation Code (54h)								
1	Reserved							DoOpc	
2	Reserved						Exclude1	Exclude0	
3	Reserved								
4	Reserved								
5	Reserved								
6	Reserved								
7	(MSB)	Parameter List Length							
8								(LSB)	
9	Control								

6.35.2.2 DoOpc

If DoOpc is set to one, the Drive shall determine OPC values for the current recording conditions. It may be necessary to perform an OPC operation. These OPC values shall become current. When DoOpc is set to one, the Parameter List Length field is ignored.

If DoOpc is set to zero, the Drive shall transfer the Parameter List and attempt to set OPC values to those in the Parameter List.

If a Drive supports this command, then it shall support DoOPC = 1.

6.35.2.3 Exclude0 and Exclude1

Exclude0 and Exclude1 allow the Host to select the layers to be calibrated.

Table 599 shows the behavior given various combinations of control bits from byte 1.

Table 599 — Drive Action with Combinations of DoOPC, Exclude0, and Exclude1

DoOpc	Exclude0	Exclude1	Drive Response
1	0	0	Perform OPC operation on each layer to set OPC values for current media speed.
1	0	1	Perform OPC operation only on layer 0 to set OPC values for current media speed.
1	1	0	Perform OPC operation only on layer 1 to set OPC values for current media speed.
1	1	1	No operation — GOOD status shall be returned
0	x	x	If Parameter List Length is zero, no operation — GOOD status shall be returned.

If the mounted media is not a recordable dual layer media supported by the Drive and either Exclude0 or Exclude1 is non-zero, then the command shall be terminated with CHECK CONDITION status and sense bytes SK/ASC/ASCQ shall be set to ILLEGAL REQUEST/INVALID FIELD IN CDB.

6.35.2.4 Parameter List Length

The Parameter List Length shall be set to reflect the number of the parameter bytes to be transferred. The Parameter List Length shall be an integral multiple of eight. If the Parameter List Length is not an integral multiple of 8, the command shall be terminated with CHECK CONDITION status and sense bytes SK/ASC/ASCQ shall be set to ILLEGAL REQUEST/INVALID FIELD IN CDB. A Parameter List Length field of zero shall not be considered an error.

If an illegal OPC table entry is detected, the Drive shall report terminate the command with CHECK CONDITION Status and set sense bytes SK/ASC/ASCQ to ILLEGAL REQUEST/INVALID FIELD IN PARAMETER LIST.

If Parameter List Length is set to zero and DoOpc is set to zero, the Drive shall perform no OPC operation.

BD-R Drives do not support receiving OPC information from the Host. If Parameter List Length is not zero, the command shall be terminated with CHECK CONDITION status and sense bytes SK/ASC/ASCQ shall be set to ILLEGAL REQUEST/INVALID FIELD IN CDB.

6.35.2.5 Parameter List Format

The format of the Parameter List is shown in Table 600.

Table 600 — SEND OPC INFORMATION Parameter List

Bit Byte	7	6	5	4	3	2	1	0
0	(MSB) OPC Speed in kBytes per Second (LSB)							
1								
2	(MSB) OPC Values (LSB)							
3								
4								
5								
6								
7								

The OPC Speed is the medium speed with which the OPC Values are associated.

The OPC Values are device, media, and speed specific.

The READ DISC INFORMATION command may return current OPC information for each write speed supported. These values may be saved in order to avoid calibration upon future media remount.

6.35.3 Command Processing

If the Drive is unable to write to the currently mounted medium, error reporting should follow the guidelines according to 4.1.6.3.

If DoOpc is requested, and the medium is not already calibrated, the Drive shall perform OPC in order to determine parameters for each speed. If the Drive has already performed calibration since the currently mounted medium first became ready, a new calibration is optional. The OPC parameters shall be made available to the Host via the READ DISC INFORMATION command.

If DoOpc is not requested, the parameter list shall be transferred and the OPC parameters shall be made current.

6.35.4 Timeouts

The SEND OPC INFORMATION command belongs to timeout group 1. If the command is terminated with CHECK CONDITION status due to a timeout, sense bytes SK/ASC/ASCQ shall be set to UNIT ATTENTION/INSUFFICIENT TIME FOR OPERATION.

6.35.5 Error Reporting

Recommended error reporting for the SEND OPC INFORMATION command is defined in Table 601.

Table 601 — Recommended errors for SEND OPC INFORMATION Command

Error	Reference
Unit Attention conditions	Table F.1
CDB or parameter list validation errors	Table F.2
Readiness errors	Table F.3
General media access errors	Table F.5
Hardware failures	Table F.8

6.36 SET CD SPEED Command

6.36.1 Introduction

The SET CD SPEED command provides A Host with a method to select a preferred physical speed for CD media.

Table 602 shows the Features associated with the SET CD SPEED command.

Table 602 — Features Associated with the SET CD SPEED Command

Feature Number	Feature Name	Command Requirement
0107h	Real-time Streaming	Optional

6.36.2 The CDB and Its Parameters

6.36.2.1 The CDB

The SET CD SPEED CDB is shown in Table 603.

Table 603 — SET CD SPEED CDB

Bit	7	6	5	4	3	2	1	0
Byte								
0	Operation Code (BBh)							
1	Reserved						Rotational Control	
2	(MSB) Drive Read Speed (bytes/sec)							
3	(LSB)							
4	(MSB) Drive Write Speed (bytes/sec)							
5	(LSB)							
6	Reserved							
7	Reserved							
8	Reserved							
9	Reserved							
10	Reserved							
11	Control							

6.36.2.2 Rotational Control

Rotational Control identifies how the Drive shall interpret the requested Drive Write Speed.

Table 604 — Rotational Control Parameter

Rotational Control	Meaning
00b	CLV and non-pure CAV
01b	Pure CAV
10b	Reserved
11b	Reserved

In the case of non-CLV rotational control on CD media, the Drive Write Speed shall be assumed to reference the speed at 79:59:74 MSF.

6.36.2.3 Drive Read Speed

A Drive Read Speed of 0000h through FFFEh specifies a minimum read speed required by the Host. A value of FFFFh requests that the Drive Read Speed be set for optimal performance.

6.36.2.4 Drive Write Speed

A Drive Write Speed of 0000h through FFFEh specifies the write speed required by the Host. A value of FFFFh requests that the Drive Write Speed be set for optimal performance. If the Drive is requested to write at an unsupported speed, the Drive shall select any slower Drive Write Speed. This condition is not regarded as an error. If the Drive is requested to write at a speed that is lower than the Drive's slowest speed, the Drive may select an appropriate Write Speed. Otherwise, the Drive shall return CHECK CONDITION status and SK/ASC/ASCQ values are set to ILLEGAL REQUEST/INVALID FIELD IN CDB.

6.36.3 Command Processing

Once the Drive has selected a speed, that speed shall be maintained until the current medium is removed. If the medium is changed and the Drive does not support the former speed, the Drive may select an appropriate speed for the current medium.

It is recommended that the Host set the Drive speeds upon the media change.

6.36.4 Timeouts

The SET CD SPEED command belongs to timeout group 1. If the command is terminated with CHECK CONDITION status due to a timeout, sense bytes SK/ASC/ASCQ shall be set to UNIT ATTENTION/INSUFFICIENT TIME FOR OPERATION.

6.36.5 Error Reporting

Recommended error reporting for the SET CD SPEED command is defined in Table 605.

Table 605 — Recommended errors for SET CD SPEED Command

Error	Reference
Unit Attention conditions	Table F.1
CDB or parameter list validation errors	Table F.2
Readiness errors	Table F.3
General media access errors	Table F.5
Write errors	Table F.7
Hardware failures	Table F.8

6.37 SET READ AHEAD Command

6.37.1 Introduction

The SET READ AHEAD command requests that the Drive perform Read Ahead Caching operations from the Read-Ahead Logical Block Address once the Drive encounters the Trigger LBA during its internal read-ahead caching operation.

Table 606 shows the Features associated with the SET READ AHEAD command.

Table 606 — Features Associated with the SET READ AHEAD Command

Feature Number	Feature Name	Command Requirement
0107h	Real-time Streaming	Mandatory

6.37.2 The CDB and Its Parameters

6.37.2.1 The CDB

The SET READ AHEAD CDB is shown in Table 607.

Table 607 — SET READ AHEAD CDB

Bit	7	6	5	4	3	2	1	0
Byte								
0	Operation Code (A7h)							
1	Reserved							
2	(MSB) Trigger Logical Block Address (LSB)							
3								
4								
5								
6								
7	(MSB) Read Ahead Logical Block Address (LSB)							
8								
9								
10								
11	Reserved							
	Control							

6.37.2.2 Trigger Logical Block Address

The Trigger Logical Block Address identifies the last sector that shall be cached during the current read-ahead caching process.

6.37.2.3 Read-Ahead Logical Block Address

The Read-Ahead Logical Block Address identifies the first sector at which caching shall continue.

If the Trigger LBA is equal to the Read Ahead LBA, no action is required and the command shall be terminated with GOOD status.

6.37.3 Command Processing

Three LBAs are involved in determining Drive action: Current caching LBA, Trigger LBA, and Read Ahead LBA. The Drive action is determined by the relationship between these 3 LBAs.

If this command is received by the Drive when data after the Trigger Logical Block Address (Trigger LBA) and before the Read Ahead Logical Block Address (Read Ahead LBA) is contained in its cache, that data should be discarded and Read Ahead Caching restarted from the specified Read Ahead Logical Block Address.

Sectors after the Trigger LBA (Not including the Trigger LBA) should be skipped. The data for both the Trigger and Read Ahead LBAs will normally be read by the host. The sectors between these addresses (exclusive) are normally not read by the Host. The host should expect seek delays if these sectors are read.

The Read-Ahead operation shall be performed in background, i.e. the Drive shall accept a command during the Read-ahead operation.

6.37.4 Timeouts

The SET READ AHEAD command belongs to timeout group 1. If the command is terminated with CHECK CONDITION status due to a timeout, sense bytes SK/ASC/ASCQ shall be set to UNIT ATTENTION/INSUFFICIENT TIME FOR OPERATION.

6.37.5 Error Reporting

Recommended error reporting for the SET READ AHEAD command is defined in Table 608.

Table 608 — Recommended errors for SET READ AHEAD Command

Error	Reference
Unit Attention conditions	Table F.1
CDB or parameter list validation errors	Table F.2
Readiness errors	Table F.3
General media access errors	Table F.5
Write errors	Table F.7
Hardware failures	Table F.8

6.38 SET STREAMING Command

6.38.1 Introduction

The SET STREAMING command provides the Host with a method to communicate requirements for data rate. The performance setting is persistent and remains until a new descriptor is sent. The setting applies only to the extent identified by the specified range. Only zero or one performance extents shall be valid at any time.

If the SET STREAMING Command is used to set performance, the Drive may disable read and write reallocation in the specified region in order to meet the performance criteria.

Table 609 shows the Features associated with the SET STREAMING command.

Table 609 — Features Associated with the SET STREAMING Command

Feature Number	Feature Name	Command Requirement
0107h	Real-time Streaming	Mandatory

6.38.2 The CDB and Its Parameters

6.38.2.1 The CDB

The SET STREAMING CDB is shown in Table 610.

Table 610 — SET STREAMING CDB

Bit Byte	7	6	5	4	3	2	1	0
0	Operation Code (B6h)							
1	Reserved							
2	Reserved							
3	Reserved							
4	Reserved							
5	Reserved							
6	Reserved							
7	Reserved							
8	Type							
9	(MSB) Parameter List Length							
10	(LSB)							
11	Control							

6.38.2.2 Type

The Type field specifies the type of data that shall be transferred. If the Drive does not report Enhanced Defect Reporting Feature, Host should set the Type field to 0. If the Drive reports the Enhanced Defect Reporting Feature, the Drive shall support the Type field. The Type field is defined in Table 611.

If the Drive does not support “Small DBI cache memory model” (see 4.7.4.5.4) and Type field is set to other than 0, the Drive shall terminate this command with CHECK CONDITION status, INVALID FIELD IN CDB.

Table 611 — Type field definition

Type field value	Reference
0	Performance descriptor
1– 4	Reserved
5	DBI cache zone descriptor
Others	Reserved

6.38.2.3 Parameter List Length

The Parameter List Length field specifies the length in bytes of the Performance Descriptor that shall be transferred from the Host to the Drive. A Parameter List Length of zero indicates that no data shall be transferred. This condition shall not be considered as an error.

If the Parameter List Length results in the truncation of Performance Descriptor, the command shall be terminated with CHECK CONDITION status and sense bytes SK/ASC/ASCQ shall be set to ILLEGAL REQUEST/PARAMETER LIST LENGTH ERROR.

6.38.3 Command Processing

6.38.3.1 General

The SET STREAMING command provides a way for the Host to indicate to the Drive that the application has specific request or requirements for Drive performance.

6.38.3.2 Performance Descriptor (Type=0)

The Host should send a Performance Descriptor during the data phase of this command. The Performance Descriptor shall be sent in the format shown in Table 612.

Table 612 — Performance Descriptor

Bit Byte	7	6	5	4	3	2	1	0	
0	Reserved			WRC		RDD	Exact	RA	
1	Reserved								
2	Reserved								
3	Reserved								
4	(MSB)	Start LBA						(LSB)	
...									
7									
8	(MSB)	End LBA						(LSB)	
...									
11									
12	(MSB)	Read Size						(LSB)	
...									
15									
16	(MSB)	Read Time						(LSB)	
...									
19									
20	(MSB)	Write Size						(LSB)	
...									
23									
24	(MSB)	Write Time						(LSB)	
...									
27									

The Write Rotation Control (WRC) field specifies the type of the medium rotation control to write. . If the Drive does not support the write rotation control mode specified, the Drive shall generate CHECK CONDITION status and SK/ASC/ASCQ values are set to ILLEGAL REQUEST/INVALID FIELD IN PARAMETER LIST.

The RDD (Restore Drive Defaults) bit, when set to zero, indicates the remaining fields are valid. When set to one, it shall indicate that the Drive is to return to its default performance settings and the remaining fields in this descriptor shall be ignored. Read and Write reallocation ability shall be restored to the operation specified by the Read/Write Error Recovery Mode Page.

The Exact bit, when set to zero, shall indicate that the Drive shall set its internal configuration to match the parameters as best as possible. No errors shall occur. When set to one, the Drive shall set its internal configuration to support the requested parameters. If the Drive is unable to perform as requested, it shall generate CHECK CONDITION status and SK/ASC/ASCQ values are set to ILLEGAL REQUEST/ INVALID FIELD IN PARAMETER LIST.

The RA (Random Access) bit, when set to zero, allows the Drive to independently set the read and write speeds. When set to one, directs the Drive to set its performance settings for the optimized settings for random changes between reading and writing by the Host. e.g., a CD recorder that is able to record at 2X and read at 6X may choose to limit reading to 2X if the RA bit was set to one.

The Start LBA field is the first logical block for which the performance request is being made.

The End LBA field is the last logical block for which the performance request is being made.

The data rate to be delivered for reading is (Read Size)/(Read Time).

The Read Size field shall indicate the number of kilobytes the Host expects to be delivered per period of Read Time when the Host's requests for data occur sufficiently fast.

The Read Time field shall indicate the amount of time, in milliseconds, over that the Read Size is expected to be read. The Host may set these two fields by setting Read Size to the size of its application's buffer and the Read Time to the amount of time it takes to empty that buffer.

The Write Size field shall be set to the number of kilobytes to be written per Write Time.

The Write Time field shall indicate the amount of time, in milliseconds, over that the Write Size is expected to be written.

In many cases, the Write Size and Write Time fields should be set to match the corresponding Read fields. If not, the Host may set the Write Size to the size of its application buffer and the Write Time to the time it takes to fill that buffer.

6.38.3.3 DBI cache zone Descriptor (Type=5)

The DBI cache zone descriptor provides a way for the Host to indicate to the Drive that the application has specific request for Drive behavior of small DBI cache model in DRT-DM mode. Disc volume space is divided into a few DBI cache zones. RDBI and WDBI memory shall be allocated for each DBI cache zones. At least two DBI cache zones shall be supported. Number of supported DBI cache zone is shown in Number of DBI cache zones field of Table 133 – Enhanced Defect Reporting Feature Descriptor.

Table 613 — DBI cache zone Descriptor

Bit	7	6	5	4	3	2	1	0
Byte								
0-7	DBI cache zone Header							
8-n	DBI cache zone Descriptor(s)							

Table 614 — DBI cache zone Header

Bit Byte	7	6	5	4	3	2	1	0
0	(MSB) DBI cache zone Data Length (LSB)							
1								
2								
3								
4-7	Reserved							

The DBI cache zone data length field specifies the length in bytes of the following data. The DBI cache zone data length value does not include the DBI cache zone data length field itself.

Table 615 — DBI cache zone Descriptor(s)

Bit Byte	7	6	5	4	3	2	1	0
0	(MSB) Start LBA of DBI cache zone (LSB)							
1								
2								
3								
4-7	Reserved							

Start LBA of DBI cache zone field specifies start LBA of a DBI cache zone. Drive shall adjust the start LBA to the packet start address that includes specified start LBA by Blocking factor for each media. The end address of a DBI cache zone is the end address of a packet that is preceded to the next DBI cache zone. The end address of the last DBI cache zone is the value of the last addressable LBA for the media. In case of C/DVD-RW media, the last readable address of the last track/RZone is the end address of the last DBI cache zone.

For C/DVD-RW media, the first DBI cache zone shall be started from 0 and Host should set the first cache zone start address to 0. In case of small DBI cache model, Host should specify 2 descriptors minimally.

If the Drive received any invalid DBI cache zone descriptor and if number of DBI cache zone descriptors exceeded the value of Number of DBI cache zones field, the Drive shall terminate this command with CHECK CONDITION status and set sense bytes SK/ASC/ASCQ to ILLEGAL REQUEST/INVALID FIELD IN PARAMETER LIST.

6.38.4 Timeouts

The SET STREAMING command belongs to timeout group 1. If the command is terminated with CHECK CONDITION status due to a timeout, sense bytes SK/ASC/ASCQ shall be set to UNIT ATTENTION/INSUFFICIENT TIME FOR OPERATION.

6.38.5 Error Reporting

Recommended error reporting for the SET STREAMING command is defined in Table 616.

Table 616 — Recommended errors for SET STREAMING Command

Error	Reference
Unit Attention conditions	Table F.1
CDB or parameter list validation errors	Table F.2
Hardware failures	Table F.8

6.39 START STOP UNIT Command

6.39.1 Introduction

The START STOP UNIT command allows the Host to request that the MM device be enabled or disabled for media access operations. This command may also be used to control certain power conditions.

Table 617 shows the Features associated with the START STOP UNIT command.

Table 617 — Features Associated with the START STOP UNIT Command

Feature Number	Feature Name	Command Requirement
0003h	Removable Medium	Mandatory
0100h	Power Management	Mandatory

6.39.2 The CDB and Its Parameters

6.39.2.1 The CDB

The START STOP UNIT CDB is shown in Table 618.

Table 618 — START STOP UNIT CDB

Bit	7	6	5	4	3	2	1	0
Byte								
0	Operation Code (1Bh)							
1	Reserved							IMMED
2	Reserved							
3	Reserved						Format-Layer Number	
4	Power Conditions				Reserved	FL	LoEj	Start
5	Control							

6.39.2.2 IMMED

If IMMED (Immediate) is set to zero, status shall be returned only after the operation is completed. If IMMED is set to one, status shall be returned as soon as the CDB has been validated.

6.39.2.3 Format-Layer Number

The Format-layer Number field specifies the Format-layer the Host has requested to be online. The number set in this field shall be less than the Number of recognized Format-layers field value reported by the Hybrid disc structure of READ DISC STRUCTURE command. If the value set in the Format-layer Number field is out of range, the Drive shall terminate the command with CHECK CONDITION status and set sense bytes SK/ASC/ASCQ to ILLEGAL REQUEST/INVALID FIELD IN CDB.

6.39.2.4 Power Conditions

The Power Conditions field requests the block device to be placed in the power condition defined in Table 619. If this field has a value other than 0h then the Start and LoEj bits are ignored.

A request to enter the current power state is not considered to be an error.

Table 619 — Power Conditions

Code	Description
0h	No change in power conditions
1h	Reserved
2h	Place Drive into the Idle State, Standby Timer is reloaded
3h	Place Drive into the Standby State
4h	Reserved
5h	Place Drive into Sleep State. IMMED has no meaning when sleep state is requested. Before entering the sleep state, all buffers shall be successfully flushed by the Drive. If the sleep command is successful, the Host should not issue new commands after receiving the successful completion status. The Device shall de-power and disable the interface only after all Drives have successfully completed the sleep operation.
6h – Fh	Reserved

6.39.2.5 FL (Format-layer)

The Format-layer (FL) bit of one requests the Drive to change the online Format-layer to the Format-layer specified by the Format-layer Number field. If FL is set to one, both LoEj bit and Start bit shall also be set to one. If the FL bit is set to one and either LoEj or Start is set to zero, the Drive shall terminate the command with CHECK CONDITION status and set sense bytes SK/ASC/ASCQ to ILLEGAL REQUEST/INVALID FIELD IN CDB.

If the FL bit is set to zero, the Format-layer Number field shall also be set to zero. If the FL bit is set to zero and the Format-layer Number is not zero, the Drive shall terminate the command with CHECK CONDITION status and set sense bytes SK/ASC/ASCQ to ILLEGAL REQUEST/INVALID FIELD IN CDB.

If the Hybrid disc Feature is present but is not current and either FL is not zero or Format-layer Number is not zero, the Drive shall terminate the command with CHECK CONDITION status and set sense bytes SK/ASC/ASCQ to ILLEGAL REQUEST/INVALID FIELD IN CDB.

6.39.2.6 LoEj and Start

When Power Conditions field is zero and FL is zero, the meanings of LoEj and Start are defined in Table 620.

Table 620 — LoEj and Start Meanings when Power Conditions = 0

LoEj	Start	Operation
0	0	Stop the disc
0	1	Start the disc and make ready for access
1	0	Eject the disc if permitted. It is not an error If no media is present. See 6.14, PREVENT ALLOW MEDIUM REMOVAL Command
1	1	Load the disc, Start the disc and make ready for access. It is not an error If no media is present.

If the Drive already has the requested state (e.g. Start = 1 and medium is already loaded and ready), the command shall be terminated with GOOD status.

6.39.3 Command Processing

6.39.3.1 Load/Eject Operations and Actions

Table 621 shows the operations that may be requested.

Table 621 — Operations of the START STOP UNIT command

FL	Format-layer Number	LoEj	Start	Power Condition	Operation Specified
0	0	0	0	0	Stop the disc
0	0	0	1	0	Start the disc and read disc structure information
0	0	1	0	0	Eject the disc if permitted (see 6.14)
0	0	1	1	0	Load and start the disc
1	N	1	1	0	Jump to Format-layer Number N
0	0	x	x	1h – Fh	Change Power Condition

If the Loading Mechanism Type is 4h (a Changer with individual disc change capability), the Eject operation shall only eject the disc that is currently in the Play Position. If the Loading Mechanism Type is 5h (a changer utilizing a Magazine), then the disc shall only be ejected when no media is in the play position.

Table 622 shows the Drive actions given various load/eject requests.

Table 622 — Load/Eject Actions

Operation	Lock Status	No Media Present	Media Present
START STOP UNIT command Eject	Unlocked	If a tray type mechanism, the tray is opened.	Disc spins down and is ejected
	Locked	The command is terminated with CHECK CONDITION status and sense bytes SK/ASC/ASCQ are set to NOT READY/MEDIUM REMOVAL PREVENTED	The command is terminated with CHECK CONDITION status and sense bytes SK/ASC/ASCQ are set to ILLEGAL REQUEST/MEDIUM REMOVAL PREVENTED
	Changer with a disc in play position		
	Changer type 4 with no disc in play position		
Manual Eject switch	Unlocked	If a tray type mechanism, the tray is opened.	Disc spins down and is ejected
	Locked	No operation occurs	No operation occurs. The disc remains locked in the Drive.

6.39.3.2 Power Condition Changes

When the Drive enters the sleep state, any queued GET EVENT/STATUS NOTIFICATION commands shall be removed from the command queue without command completion.

If any commands other than GET EVENT STATUS NOTIFICATION are in the command queue when a sleep requested, the command shall be terminated with CHECK CONDITION status and sense bytes SK/ASC/ASCQ shall be set to ILLEGAL REQUEST/COMMAND SEQUENCE ERROR.

If a request to go to a power state fails, the Drive shall remain in the current power state and shall generate power management class event with the Power Event Field set to PwrChg-Fail.

All power state change requests, except sleep, that complete successfully shall generate a power management class event with the Power Event field set to PwrChg-Successful.

Notification of power states shall occur upon entering a new power state.

6.39.4 Timeouts

The START STOP UNIT command belongs to timeout group 1. If the command is terminated with CHECK CONDITION status due to a timeout, sense bytes SK/ASC/ASCQ shall be set to UNIT ATTENTION/INSUFFICIENT TIME FOR OPERATION.

6.39.5 Error Reporting

Recommended error reporting for the START STOP UNIT command is defined in Table 623.

Table 623 — Recommended errors for START STOP UNIT Command

Error	Reference	May be Deferred
Unit Attention conditions	Table F.1	
CDB or parameter list validation errors	Table F.2	
General media access errors		√
Hardware failures	Table F.8	√

6.40 SYNCHRONIZE CACHE Command

6.40.1 Introduction

The purpose of the SYNCHRONIZE CACHE command is to ensure that logical blocks in the cache memory have their most recent data value recorded on the physical medium. If a more recent data value for a logical block exists in the cache memory than on the physical medium, then the logical blocks from the cache memory shall be written to the physical medium.

Table 624 shows the Features associated with the SYNCHRONIZE CACHE command.

Table 624 — Features Associated with the SYNCHRONIZE CACHE Command

Feature Number	Feature Name	Command Requirement
0020h	Random Writable	Mandatory
0021h	Incremental Streaming Writable	Mandatory
0025h	Write Once	Mandatory
0026h	Restricted Overwrite	Mandatory
0027h	CD-RW CAV Write	Mandatory
0029h	Enhanced Defect Reporting	Mandatory
002Bh	DVD+R	Mandatory (when Write bit is set to one)
002Ch	Rigid Restricted Overwrite	Mandatory
002Dh	CD Track At Once	Mandatory
002Eh	CD Mastering (RAW)	Mandatory
003Bh	DVD+R DL	Mandatory (when Write bit is set to one)
0042h	TSR	Mandatory

6.40.2 The CDB and Its Parameters

6.40.2.1 The CDB

The SYNCHRONIZE CACHE CDB is shown in Table 625.

Table 625 — SYNCHRONIZE CACHE CDB

Bit	7	6	5	4	3	2	1	0
Byte								
0	Operation Code (35h)							
1	Reserved						IMMED	Obsolete
2	(MSB) Logical Block Address (LSB)							
3								
4								
5								
6								
7	(MSB) Number of Blocks (LSB)							
8								
9	Control							

6.40.2.2 IMMED

If IMMED (Immediate) is set to zero, status shall be returned only after the operation is completed. If IMMED is set to one, status shall be returned as soon as the CDB has been validated.

6.40.2.3 Logical Block Address

The Drive may ignore the Logical Block Address field.

6.40.2.4 Number of Blocks

The Drive may ignore the Number of Blocks field.

6.40.3 Command Processing

In streamed write operations, the SYNCHRONIZE CACHE command shall force conditions equivalent to a buffer underrun.

If all data in the cache is synchronized with the media when this command is received, it shall not be considered an error.

6.40.4 Timeouts

The SYNCHRONIZE CACHE command belongs to timeout group 2 when IMMED is zero. The group 2 timeout value is only for Host information. The Drive shall not time group 2 timeout commands. Execution shall continue until completion.

When the IMMED is set to one, status shall be returned within a Group 1 timeout.

6.40.5 Error Reporting

Recommended error reporting for the SYNCHRONIZE CACHE command is defined in Table 626.

Table 626 — Recommended errors for SYNCHRONIZE CACHE Command

Error	Reference	May be Deferred
Unit Attention conditions	Table F.1	
CDB or parameter list validation errors	Table F.2	
General media access errors		√
Hardware failures	Table F.8	√

6.41 TEST UNIT READY Command

6.41.1 Introduction

The TEST UNIT READY Command provides a means to check if the Drive is ready. This is not a request for a self-test. The features associated with this command are shown in Table 627.

Table 627 — Features Associated with the TEST UNIT READY Command

Feature Number	Feature Name	Command Requirement
0001h	Core Feature	Mandatory

The TEST UNIT READY command is described in [SPC-3].

6.41.2 Timeouts

The TEST UNIT READY command belongs to timeout group 1. If the command is terminated with CHECK CONDITION status due to a timeout, sense bytes SK/ASC/ASCQ shall be set to UNIT ATTENTION/INSUFFICIENT TIME FOR OPERATION.

6.41.3 Error Reporting

Recommended error reporting for the TEST UNIT READY command is defined in Table 628.

Table 628 — Recommended errors for TEST UNIT READY Command

Error	Reference
Unit Attention conditions	Table F.1
CDB or parameter list validation errors	Table F.2
General media access errors	
Hardware failures	Table F.8

6.42 VERIFY (10) Command

6.42.1 Introduction

Table 629 shows the Features associated with the VERIFY (10) command.

Table 629 — Features Associated with the VERIFY (10) Command

Feature Number	Feature Name	Command Requirement
0022h	Sector Erasable	Mandatory
0023h	Formattable	Mandatory
0028h	MRW	Mandatory
002Ch	Rigid Restricted Overwrite	Mandatory

6.42.2 The CDB and Its Parameters

6.42.2.1 The CDB

The VERIFY (10) CDB is shown in Table 630.

Table 630 — VERIFY (10) CDB

Bit	7	6	5	4	3	2	1	0
Byte								
0	Operation Code (2Fh)							
1	Reserved			DPO	Reserved		BytChk	Obsolete
2	Logical Block Address (MSB) (LSB)							
3								
4								
5								
6	G3tout	Reserved						
7	Number of Blocks (MSB) (LSB)							
8								
9	Control							

6.42.2.2 DPO

Disable Page Out (DPO) is not used by MM Drives and shall be set to zero.

6.42.2.3 BytChk

BytChk (Byte Check) is not used by MM Drives and shall be set to zero.

6.42.2.4 Logical Block Address

Logical Block Address references the block at which the operation shall begin.

6.42.2.5 Number of Blocks

Number of Blocks specifies the number of contiguous logical blocks of data or blanks that shall be verified. If Number of Blocks is zero indicates that no logical blocks shall be verified. This condition shall not be considered as an error. Any other value indicates the number of logical blocks that shall be verified.

6.42.2.6 G3tout

If the G3tout bit is set to 1 and if the Drive supports Group3 timeout and if Restricted Overwrite Feature or Rigid Restricted Overwrite Feature (e.g., CD-RW, DVD-RW) is current and if the G3Enable bit in Timeout & Protect

Mode Page (1Dh) is set to 1, the Drive shall terminate this command within Group 3 timeout. In other cases, this command is categorized as Group 2 timeout.

6.42.3 Command Processing

Verify Error Recovery Mode Page parameters are not supported by MM Drives. The Drive shall utilize the Read/Write Error Recovery Mode Page as verify parameters. For Writable device-media systems with defect management, the ARRE bit shall control automatic reallocation.

If the currently mounted medium is DVD-RAM, the verify operation of this command shall use stricter criteria for data recoverability than is used by read commands. The criteria are derived from the DVD-RAM Book, with additional vendor specific criteria allowed.

If the currently mounted medium is CD-RW with MRW formatting operating in background, DVD+RW with basic formatting operating in background, or DVD+RW with MRW formatting operating in background, the VERIFY command operation shall be as follows:

5. If any of the sectors within the range specified by the CDB are in a blank area of the media where format writing has not yet occurred, the blank sectors shall not be read and the command shall operate as if the sectors had been verified as good.
6. If all of the sectors within the range specified by the CDB are in an area of the media where format writing has occurred, the command shall operate normally.

If Enhanced Defect Reporting Feature is current, the Drive shall follow the setting of the PER bit and the EMCDCR field in Read/Write Error Recovery Parameters Mode Page (01h). See clause 4.7.

6.42.4 Timeouts

The VERIFY (10) command belongs to timeout group 2. The group 2 timeout value is only for Host information. The Drive shall not time group 2 timeout commands. Execution shall continue until completion.

If the Drive supports Group3 time-out and the G3Enable bit in Time-out & Protect Mode Page (1Dh) is set to 1, VERIFY (10) is re-categorized as Group 3 time-out. Refer to 4.1.9.5.

6.42.5 Error Reporting

Recommended error reporting for the VERIFY (10) command is defined in Table 631.

Table 631 — Recommended errors for VERIFY (10) Command

Error	Reference	May be Deferred
Unit Attention conditions	Table F.1	
CDB or parameter list validation errors	Table F.2	
General media access errors		
Hardware failures	Table F.8	

6.43 WRITE (10) Command

6.43.1 Introduction

The WRITE (10) Command requests that the Drive write Host data to the medium. In order to achieve correct operation, the Drive may require information from the Write Parameters Mode Page.

Table 632 shows the Features associated with the WRITE (10) command.

Table 632 — Features Associated with the WRITE (10) Command

Feature Number	Feature Name	Command Requirement
0020h	Random Writable	Mandatory
0021h	Incremental Streaming Writable	Mandatory
0022h	Sector Erasable	Mandatory
0025h	Write Once	Mandatory
0026h	Restricted Overwrite	Mandatory
0027h	CD-RW CAV Overwrite	Mandatory
0028h	MRW	Mandatory (when Write bit is set)
0029h	Enhanced Defect Reporting	Mandatory
002Ah	DVD+RW	Mandatory (when Write bit is set)
002Bh	DVD+R	Mandatory (when Write bit is set)
002Ch	Rigid Restricted Overwrite	Mandatory
002Dh	CD Track At Once	Mandatory
002Eh	CD Mastering (both SAO and RAW)	Mandatory
002Fh	DVD-R/-RW	Mandatory
003Ah	DVD+RW DL	Mandatory (when Write bit is set)
003Bh	DVD+R DL	Mandatory (when Write bit is set)
0041h	BD Write	Mandatory
0042h	TSR	Mandatory
0051h	HD DVD Write	Mandatory

6.43.2 The CDB and Its Parameters

6.43.2.1 The CDB

The WRITE (10) CDB is shown in Table 633.

Table 633 — WRITE (10) CDB

Bit Byte	7	6	5	4	3	2	1	0
0	Operation Code (2Ah)							
1	Reserved			FUA	Reserved	TSR	Reserved	
2	(MSB) Logical Block Address (LSB)							
3								
4								
5								
6								
7	(MSB) Transfer Length (LSB)							
8								
9	Control							

6.43.2.2 FUA

A FUA (force unit access) bit, set to one, indicates that the Drive shall access the media in performing the command prior to returning GOOD status. In the case where the cache contains a more recent version of a

logical block than the media, the logical block shall first be written to the media. WRITE commands shall not return GOOD status until the logical blocks have actually been written on the media, and the Write process is complete. This mode may not operate correctly with a sequence of writes intended to produce a continuous stream unless command queuing is implemented

A FUA bit of zero indicates that the Drive may satisfy the command by accessing the cache memory. For WRITE operations, logical blocks may be transferred directly to the cache memory. GOOD status may be returned to the Host prior to writing the logical blocks to the medium. Any error that occurs after the GOOD status is returned is a deferred error, and information regarding the error is not reported until the following command.

6.43.2.3 TSR

Timely Safe Recording (TSR) bit, set to one, indicates during phase one that the Drive shall detect and report defective writable units within the Error reporting threshold set in Read/Write Error Detection and Recovery Parameters Mode Page (page code 01h). The Drive may perform certify before write or may perform verification after write or both or another method of error detection but shall ensure error detection is performed. The same bit, set to one, indicates also that replacement due to defect shall not be performed at this time – AWRE (Automatic Write Reallocation Enabled) and Write Retry Count settings from Read/Write Error Detection and Recovery mode page shall be ignored – no automatic reallocation and no write retry is allowed.

The host may perform writing with TSR bit set to one, and then may repeat the writing of signaled defective writable units with TSR bit set to zero (rewritable media) or one (write-once media). For best performance, the Drive may remember the defective writable units after reporting them to the host in order to avoid the work of detection if the host writes again this particular writable unit (with or without TSR set to one). For Write-Once media during this phase one, the LBA in CDB shall match an unrecorded LBA. Combination of Pseudo-Overwrite and TSR in a single write command is not permitted.

TSR bit set to one indicates during phase two that the Drive shall perform hardware defect management. This is for the sole use on write once media. During this phase, the LBA in CDB shall match a recorded LBA. Additionally, the Drive shall ensure the LBA matches a DFL entry or a defect found during phase one (if not, the write command shall be terminated with CHECK CONDITION status and SK/ASC/ASCQ values shall be set to ILLEGAL REQUEST/INVALID FIELD IN CDB). The data shall be written by the Drive to the spare area and the DFL shall be updated to reflect this remapping, as if the Drive was performing a defect management for this block.

See 4.9 to distinguish phase one and two on write once media.

If TSR bit is set to one and if the TSR is not present or not current, the Drive shall terminate the command with CHECK CONDITION status and SK/ASC/ASCQ values shall be set to ILLEGAL REQUEST/INVALID FIELD IN CDB.

If the LBA and transfer length is not matching ECC block first byte and ECC block end, and TSR bit is set to one, the Drive shall fail the command with check condition and SK/ASC/ASCQ values shall be set to ILLEGAL REQUEST/INVALID FIELD IN CDB.

When TSR bit is set to zero, no change to the behavior of the command is to be performed. However for rewritable media, if TSR is set to zero, and if the writable unit was detected as defective during the execution of an earlier write command with TSR set to one, the Drive may perform replacement immediately, without first attempting to record the known-as-defective writable unit.

FUA and TSR bits are not mutually exclusive. If both FUA and TSR bits are set to one during the phase one of TSR, the Drive shall perform the error detection prior to returning GOOD status. In case a defect is detected, it shall be reported as CHECK CONDITION and sense bytes SK/ASC/ASCQ WRITE ERROR. RECOVERY NEEDED immediately and shall not be reported as deferred error.

6.43.2.4 Logical Block Address

The Logical Block Address field specifies the logical block where the write operation shall begin. If Starting Logical Block Address is not within the range specified by the READ CAPACITY command response, the command shall be terminated with CHECK CONDITION status and sense bytes SK/ASC/ASCQ shall be set to ILLEGAL REQUEST/LOGICAL BLOCK ADDRESS OUT OF RANGE. When the Random Writable Feature is not current, valid Logical Block Addresses may be further restricted. In such cases, if the Starting Logical Block Address is not valid, the command shall be terminated with CHECK CONDITION status and sense bytes

SK/ASC/ASCQ shall be set to ILLEGAL REQUEST/INVALID ADDRESS FOR WRITE. For all DVD media, the write block size is 2 048 bytes. The Write Parameters Mode Page shall determine the write block size for writable CD media.

6.43.2.5 Transfer Length

The Transfer Length specifies the number of contiguous logical blocks of data that shall be transferred. A Transfer Length of zero indicates that no data shall be transferred. This condition shall not be considered an error and no data shall be written.

6.43.3 Command Processing

6.43.3.1 General

If the Drive is unable to write to the currently mounted medium, error reporting should follow the guidelines according to 4.1.6.3.

If the currently mounted disc is write-once, the POW Feature is not current, and any block in the write range has already been written, the command shall be terminated with CHECK CONDITION and SK/ASC/ASCQ values shall be set to ILLEGAL REQUEST/INVALID ADDRESS FOR WRITE.

6.43.3.2 CD-R Fixed Packet, Variable Packet, Track-At-Once

The Logical Block Address shall be valid within the range 0 through MAXLBA where MAXLBA is the address limit reported by the READ CAPACITY command.

For each track on the disc in which the Track Information reports a valid Next Writable Address, the starting LBA shall be one of the Next Writable Addresses.

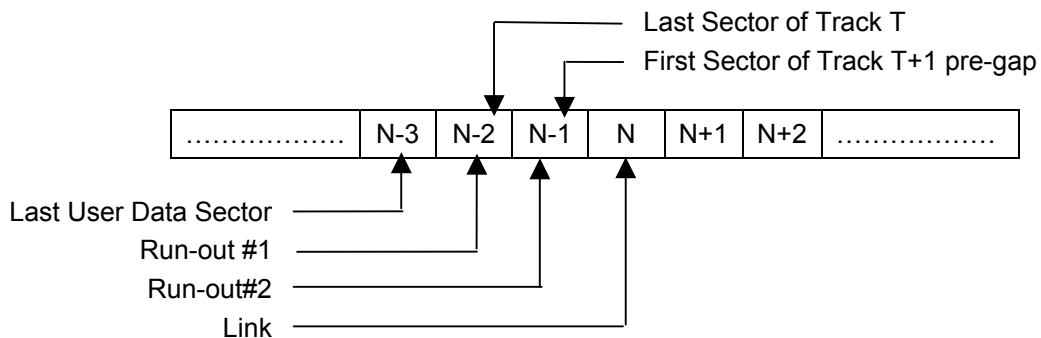

If the Starting LBA plus the Transfer Length minus 3 is greater than the remaining blank space of the track, the data shall be written until the end of track is encountered

6.43.3.3 SAO Raw on CD-R/-RW, DAO and Incremental on DVD-R/-RW

Session-At-Once Raw recording begins in the disc lead-in. LBAs in the range of -45 150 (FFFF4FA2h) to -1 (FFFFFFFFh) shall be encoded as a two's complement negative number. Values in the range 0 through FFFF4FA1h shall be considered positive values.

Table 634 shows the LBA to MSF mapping.

For CD-R/RW media, the block size shall be determined by the Write Parameters Page (if in track at once, packet, or raw mode) or by the cue sheet (session at once mode).

If the medium is MRW formatted or in progress with MRW formatting, then the block size shall be 2 048 bytes. The Logical Block Address shall be valid within the range 0 through MAXLBA where MAXLBA is the address reported by the READ CAPACITY command.

Table 634 — LBA to MSF translation

Condition	Formulae
-----------	----------

$-150 \leq LBA \leq 404\,849$	$M = IP\left(\frac{LBA + 150}{60 * 75}\right)$ $S = IP\left(\frac{LBA + 150 - M * 60 * 75}{75}\right)$ $F = IP(LBA + 150 - M * 60 * 75 - S * 75)$
$-451\,150 \leq LBA \leq -151$	$M = IP\left(\frac{LBA + 450150}{60 * 75}\right)$ $S = IP\left(\frac{LBA + 450150 - M * 60 * 75}{75}\right)$ $F = IP(LBA + 450150 - M * 60 * 75 - S * 75)$
$00:00:00 \leq MSF \leq 89:59:74$	$LBA = (M * 60 + S) * 75 + F - 150$
$90:00:00 \leq MSF \leq 99:59:74$	$LBA = (M * 60 + S) * 75 + F - 450150$

For CD-R and DVD-R, once actual writing to the media has started, the data stream is typically uninterrupted until the recording is done. Interruptions of data are called "under-run." The under-run condition may also be forced with the SYNCHRONIZE CACHE command. The Drive shall behave as follows in an under-run condition.

1. Session at Once mode (Disc at Once mode for DVD): The Drive shall generate and write a Lead-out (the Lead-in was generated and written before any data). The Drive shall update the PMA (CD) or RMA (DVD).
2. Track at Once mode: The Drive shall pad the track (if reserved or not minimum length) and update the PMA (CD).
3. Variable Packet (Incremental mode of DVD): For CD, if insufficient space exists for another variable packet within a reserved track, the Drive shall pad the packet such that it fills the track. Otherwise, the Drive shall write run-out and link blocks. For DVD the Drive shall perform linking.
4. Fixed Packet (Restricted Overwrite mode CD-RW): The Drive shall pad the packet.
5. Raw mode: The Drive shall write run-out and link blocks. The Drive shall read the TOC and track information from the session just written and update the PMA. It is assumed that the Host has written the Lead-out.
6. Rigid Restricted Overwrite mode (DVD-RW): The start address and the end address of a write command shall be ECC block boundary. If the address is not ECC block boundary, the Drive shall return a CHECK CONDITION status and SK/ASC/ASCQ values are set to ILLEGAL REQUEST/INVALID ADDRESS FOR WRITE.

If the block number specified by the LBA field is already written on CD-R media, the Drive shall return a CHECK CONDITION status and SK/ASC/ASCQ values are set to ILLEGAL REQUEST/INVALID ADDRESS FOR WRITE. This error indicates that an under-run may have occurred, as the run-out and link blocks occupy logical addresses. On CD-RW media, the LBA shall specify an address that is an appendable point (according to CD-R rules) or is the first user data block of an existing packet or track.

While writing is occurring, the Drive may not be able to process all commands. The following is a list of commands that shall function during writing without causing a SYNCHRONIZE CACHE.

1. TEST UNIT READY
2. REQUEST SENSE
3. INQUIRY
4. READ TRACK INFO (for current track). If the LBA or track number specified is not within the current track, the Drive may return CHECK CONDITION status and SK/ASC/ASCQ values are set to ILLEGAL REQUEST/INVALID FIELD IN CDB.

5. READ BUFFER CAPACITY
6. WRITE with the NWA in the current track.
7. GET CONFIGURATION
8. GET EVENT STATUS NOTIFICATION

All other commands shall process normally, but may force a SYNCHRONIZE CACHE before executing. The process of writing from the Drive's cache to the medium shall not cause a not ready condition for any command. When the Drive is padding a reserved track or writing Lead-in and Lead-out, a WRITE command may be terminated with CHECK CONDITION status with SK/ASC/ASCQ values set to LOGICAL UNIT NOT READY, LONG WRITE IN PROGRESS.

When Restricted Overwrite method is currently performed (Restricted Overwrite Feature (0026h) or Rigid Restricted Overwrite Feature (002Ch)), READ (10) command or READ (12) command shall be performed normally after data in buffer is written on the disc.

In case of DRT-DM mode, when Enhanced Defect Reporting Feature (0029h) is current and when the EMCDR field is set to 2 or 3, and if a Type 1, Type 2, or Type 3 defect level is found in DBI memory for any of the blocks being written, the Drive shall terminate the command with CHECK CONDITION status and sense bytes SK/ASC/ASCQ shall be set to RECOVERED ERROR/ RECOVERED DATA – RECOMMEND REASSIGNMENT at the completion of the command. Type 4 defect shall be stored in DBI memory. Data in buffer shall be written on the medium normally.

6.43.3.4 Write Protect

If the currently mounted disc is write protected, the command shall be terminated with CHECK CONDITION status and sense shall be set according to 4.11.9.

6.43.4 Timeouts

The WRITE (10) command belongs to timeout group 1. If the command is terminated with CHECK CONDITION status due to a timeout, sense bytes SK/ASC/ASCQ shall be set to NOT READY/ INSUFFICIENT TIME FOR OPERATION. When the FUA bit in the CDB is set to zero, and the WCE bit in the Cacheing Page is set to one timeouts are permitted only as deferred errors.

6.43.5 Error Reporting

Recommended error reporting for the WRITE (10) command is defined in Table 635.

Table 635 — Recommended errors for WRITE (10) Command

Error	Reference	May be Deferred
Unit Attention conditions	Table F.1	
CDB or parameter list validation errors	Table F.2	
General media access errors		√
Errors Associated with writing		√
Hardware failures	Table F.8	√

6.44 WRITE (12) Command

6.44.1 Introduction

The WRITE (12) command requests that the Drive write Host data to the medium. In order to achieve correct operation, the Drive may require information from the Write Parameters Mode Page.

Table 636 shows the Features associated with the WRITE (12) command.

Table 636 — Features Associated with the WRITE (12) Command

Feature Number	Feature Name	Command Requirement
002Ah	DVD+RW	Mandatory (when Write bit is set to one)
0107h	Real-time Streaming	Mandatory

6.44.2 The CDB and Its Parameters

6.44.2.1 The CDB

The WRITE (12) CDB is shown in Table 637.

Table 637 — WRITE (12) CDB

Bit	7	6	5	4	3	2	1	0	
Byte									
0	Operation Code (AAh)								
1	Reserved			FUA	Reserved	TSR	Reserved		
2	Logical Block Address								
3									(MSB)
4									
5									
									(LSB)
6	Transfer Length								
7									(MSB)
8									
9									
									(LSB)
10	Streaming	VNR	Reserved						
11	Control								

6.44.2.2 FUA

The Force Unit Access (FUA) bit is defined in 6.43.2.2.

6.44.2.3 TSR

The Timely Safe Recording (TSR) bit is defined in 6.43.2.3.

6.44.2.4 Logical Block Address

The Logical Block Address field specifies the logical block where the write operation shall begin. If Starting Logical Block Address is not within the range specified by the READ CAPACITY command response, the command shall be terminated with CHECK CONDITION status and sense bytes SK/ASC/ASCQ shall be set to ILLEGAL REQUEST/LOGICAL BLOCK ADDRESS OUT OF RANGE. When the Random Writable Feature is not current, valid Logical Block Addresses may be further restricted. In such cases, if the Starting Logical Block Address is not valid, the command shall be terminated with CHECK CONDITION status and sense bytes SK/ASC/ASCQ shall be set to ILLEGAL REQUEST/INVALID ADDRESS FOR WRITE. For all DVD media, the

write block size is 2 048 bytes. The Write Parameters Mode Page shall determine the write block size for writable CD media.

6.44.2.5 Transfer Length

The Transfer Length specifies the number of contiguous logical blocks of data that shall be transferred. A Transfer Length of zero indicates that no data shall be transferred. This condition shall not be considered an error and no data shall be written.

6.44.2.6 VNR

6.44.2.6.1 When the Currently Mounted Disc is not BD-R

VNR is applicable only to BD-R. The Drive shall ignore VNR when the currently mounted media is not BD-R.

6.44.2.6.2 When the Currently Mounted Disc is BD-R

If the Hardware Defect Management feature is current, non-streamed writes should be verified by the Drive in an automatic, verify-after-write process. Some applications may be designed to expect behavior associated with Drives and media that do not automatically perform verify-after-write (e.g. write-once media without spare areas). The VNR (Verify-Not-Required) bit provides a method by which the Drive **may** provide both behaviors.

If Streaming is set to one, VNR has no meaning.

If Streaming is set to zero and VNR is set to one, the default behavior of automatic verify-after-write functions are unchanged.

If Streaming is set to zero and VNR is set to one, the default automatic verify-after-write functions in the BD-R Drive should be disabled.

6.44.3 Command Processing

6.44.3.1 General

When Streaming is set to zero and VNR is set to zero, the description of the WRITE (12) command is the same as the WRITE (10) command.

6.44.3.2 Blocking Factor

The Starting LBA and the Transfer Length identify a logical track into which the data is to be written. The Track Information for that logical track identifies a Blocking Factor. When the Host issues the command with the Streaming bit set to one, the values of the Starting Logical Block Address and the Transfer Length fields shall each be an integral multiple of the Blocking factor. If either the Starting Logical Block Address field or the Transfer Length field is not set to an integral multiple of the Blocking Factor, the command shall be terminated with CHECK CONDITION status and sense bytes SK/ASC/ASCQ shall be set to ILLEGAL REQUEST/INVALID FIELD IN CDB.

6.44.3.3 Streaming

If the Streaming bit is zero, the write operation shall be according to the WRITE (10) command. If the Streaming bit is one, Stream recording operation shall be used for the command.

If the Streaming bit is set to 1 and if the Drive supports Group3 timeout and if G3Enable bit in Timeout & Protect Mode Page (1Dh) is set to 1, the Drive shall terminate this command within Group 3 timeout. If the G3Enable bit is set to 0, this command is categorized as Group 1 timeout.

When the Streaming bit is set to one, the FUA bit shall be set to zero. If both the Streaming bit and the FUA bit are set to one, the command shall be terminated with CHECK CONDITION status with SK/ASC/ASCQ values set to ILLEGAL REQUEST/INVALID FIELD IN CDB.

If the Streaming bit is set to one and the Caching Page is supported, the WCE (Write Cache Enable) bit in the Caching Page shall be set to one. If the Streaming bit is set to one and WCE is zero, the command shall be terminated with CHECK CONDITION status with SK/ASC/ASCQ values set to ILLEGAL REQUEST/INVALID FIELD IN CDB.

TSR and Streaming bits are not mutually exclusive. When both bits are set to one, the Drive shall perform stream write with error detection and report but no replacement if a defect is found. If insufficient time is available to perform error detection given the data rate streaming requirement set by the host through an earlier SET STREAMING Command, and given the Error reporting threshold set by the host through an earlier MODE SELECT on Read/Write Error Detection and Recovery Parameters Mode Page, the command is terminated with

CHECK CONDITION status due to a timeout, sense bytes SK/ASC/ASCQ shall be set to ILLEGAL REQUEST/INSUFFICIENT TIME FOR OPERATION.

With TSR and Streaming bits combination, the host software will have a guaranteed average streaming speed, but has to expect the write to be done by burst by the Drive. Hence the host software has buffer data between bursts (while Drive is detecting potential errors),

6.44.3.4 Unable to Write

If the Drive is unable to write to the currently mounted medium, error reporting should follow the guidelines according to 4.1.6.3.

6.44.3.5 DVD-RAM

For the DVD-RAM Ver.2.1, the Drive shall set to one all Recording Type bits that are in the Data ID fields of all sectors within the ECC Block to be written, when WRITE (12) command with the Streaming bit set to one is issued by the Host. The Drive shall set all the Recording Type bits to zero when WRITE (12) command with the Streaming bit set to zero is issued by the Host.

6.44.3.6 DVD+RW

If the media is DVD+RW and is blank (never formatted), then a write to any address shall be terminated with CHECK CONDITION status and SK/ASC/ASCQ values shall be set to ILLEGAL REQUEST/MEDIUM NOT FORMATTED.

6.44.4 Timeouts

The WRITE (12) command belongs to timeout group 1. If the command is terminated with CHECK CONDITION status due to a timeout, sense bytes SK/ASC/ASCQ shall be set to NOT READY/ INSUFFICIENT TIME FOR OPERATION. When the FUA bit in the CDB is set to zero, and the WCE bit in the Cacheing Page is set to one timeouts are permitted only as deferred errors.

If the Drive supports Group3 time-out and the G3Enable bit in Time-out & Protect Mode Page (1Dh) is set to 1, WRITE (12) with Streaming = 1 is re-categorized as Group 3 time-out. Refer to 4.1.9.5.

6.44.5 Error Reporting

Recommended error reporting for the WRITE (12) command is defined in Table 638.

Table 638 — Recommended errors for WRITE (12) Command

Error	Reference	May be Deferred
Unit Attention conditions	Table F.1	
CDB or parameter list validation errors	Table F.2	
General media access errors		√
Errors Associated with writing		√
Hardware failures	Table F.8	√

6.45 WRITE AND VERIFY (10) Command

6.45.1 Introduction

The WRITE AND VERIFY (10) command requests that the Drive write the data transferred from the Host to the medium and then verify that the data is correctly written.

Table 639 shows the Features associated with the WRITE AND VERIFY (10) command.

Table 639 — Features Associated with the WRITE AND VERIFY (10) Command

Feature Number	Feature Name	Command Requirement
0020h	Random Writable	Mandatory
0025h	Write Once	Mandatory
0028h	MRW	Mandatory (when Write bit is set to one)
002Ah	DVD+RW	Mandatory (when Write bit is set to one)

6.45.2 The CDB and Its Parameters

6.45.2.1 The CDB

The WRITE AND VERIFY (10) CDB is shown in Table 640.

Table 640 — WRITE AND VERIFY (10) CDB

Bit	7	6	5	4	3	2	1	0
Byte								
0	Operation Code (2Eh)							
1	Reserved						TSR	Reserved
2	(MSB) Starting Logical Block Address (LSB)							
3								
4								
5								
6	Reserved							
7	(MSB) Transfer Length (LSB)							
8								
9	Control							

6.45.2.2 TSR

The Timely Safe Recording (TSR) bit is defined in 6.43.2.3.

6.45.2.3 Starting Logical Block Address

Starting Logical Block Address references the block at which the operation shall begin.

6.45.2.4 Transfer Length

Transfer length specifies the number of contiguous logical blocks of data or blanks that shall be written and verified. A transfer length of zero indicates that no logical blocks shall be verified. This condition shall not be considered as an error. Any other value indicates the number of logical blocks that shall be verified.

6.45.3 Command Processing

If the Drive is unable to write to the currently mounted medium, error reporting should follow the guidelines according to 4.1.6.3.

Writing shall be according to the description of the WRITE (10) command with the FUA bit is set to one.

Verify Error Recovery Mode Page parameters are not supported by MM Drives. The Drive shall utilize the Read/Write Error Recovery Mode Page as verify parameters. The AWRE and ARRE bits shall control automatic reallocation.

If Enhanced Defect Reporting Feature (0029h) is current, the Drive shall follow the setting of the PER bit and the EMCDR field in Read/Write Error Recovery Parameters Mode Page (01h). See Clause 4.7.

If the currently mounted medium is DVD-RAM, the verify operation of this command shall use stricter criteria for data recoverability than is used by read commands. The criteria are derived from the DVD-RAM Book, with additional vendor specific criteria allowed.

If the currently mounted medium is DVD-RAM Ver.2.1, the Drive shall set to zero all Recording Type bits that are in the Data ID fields of all sectors within the ECC Block to be written.

If the currently mounted medium is DVD+RW and the medium is blank (never formatted), then a write to any address shall be terminated with CHECK CONDITION status and SK/ASC/ASCQ values shall be set to ILLEGAL REQUEST/MEDIUM NOT FORMATTED.

6.45.4 Timeouts

The WRITE AND VERIFY (10) command belongs to timeout group 2. The group-2 timeout value is only for Host information. The Drive shall not time group 2 timeout commands. Execution shall continue until completion.

6.45.5 Error Reporting

Recommended error reporting for the WRITE AND VERIFY (10) command is defined in Table 641.

Table 641 — Recommended errors for WRITE AND VERIFY (10) Command

Error	Reference	May be Deferred
Unit Attention conditions	Table F.1	
CDB or parameter list validation errors	Table F.2	
General media access errors		√
Hardware failures	Table F.8	√

6.46 WRITE BUFFER Command

6.46.1 Introduction

The WRITE BUFFER Command is used in conjunction with the READ BUFFER Command as a diagnostic function for testing Drive memory in the target device and the integrity of the service delivery subsystem. Additional modes are provided for downloading/saving microcode. This command shall not alter any medium of the Drive when the data mode or the combined header and data mode is specified.

The features associated with this command are shown in Table 642.

Table 642 — Features Associated with the WRITE BUFFER Command

Feature Number	Feature Name	Command Requirement
0104h	Microcode Upgrade	Mode 00111b is Mandatory

The WRITE BUFFER command is described in [SPC-3].

6.46.2 Timeouts

The WRITE BUFFER command belongs to timeout group 1. If the command is terminated with CHECK CONDITION status due to a timeout, sense bytes SK/ASC/ASCQ shall be set to UNIT ATTENTION/INSUFFICIENT TIME FOR OPERATION.

6.46.3 Error Reporting

Table 643 describes errors that may occur during the operation of the Command or that may cause a CHECK CONDITION status to be reported.

Table 643 — WRITE BUFFER Command Errors

Error	Reference
Unit Attention conditions	Table F.1
CDB or parameter list validation errors	Table F.2
Hardware failures	Table F.8

This page is intentionally blank

7 Mode Parameters for Multi-Media Devices

7.1 Overview

This clause describes the mode parameter headers and mode pages used with the MODE SELECT (10) command and the MODE SENSE (10) command.

7.2 Mode Parameter List

A mode parameter list shall be transferred from the Drive to the Host during the execution of the MODE SENSE (10) command. A mode parameter list shall be transferred from the Host to the Drive during the execution of the MODE SELECT (10) command.

The mode parameter list (Table 644) contains a header followed by zero or more variable-length mode pages.

Table 644 — Mode Parameter List

Bit	7	6	5	4	3	2	1	0
Byte								
0 – 7	Mode Parameter Header							
8 – n	Mode Page(s)							

7.2.1 Mode Parameter Header Format

The Mode Parameters Header (Table 645) contains information about subsequent mode parameter data.

Table 645 — Mode Parameters Header

Bit	7	6	5	4	3	2	1	0
Byte								
0	(MSB) Mode Data Length (LSB)							
1								
2	Reserved							
3	Reserved							
4	Reserved							
5	Reserved							
6	(MSB) Block Descriptor Length = 0 (LSB)							
7								

When returned by the MODE SENSE (10) command, the Mode Data Length field is the length in bytes of available data that follows the Mode Data Length field. The Mode Data Length does not include the number of bytes in the Mode Data Length field.

When transferred during execution of the MODE SELECT (10) command, Mode Data Length is reserved.

Block Descriptor length shall be set to zero since Multi-media devices do not support Block Descriptors.

7.2.2 Mode Pages

Mode Pages are used to provide parametric information from the Drive to the Host or from the Host to the Drive. Table 646 shows mode pages available to Multi-media Drives.

Since MM Drives do not support sub-pages of mode pages, the Sub-Page field of the MODE SELECT (10) command is ignored by the Drive.

Table 646 — Mode Pages for MM Drives

Page Code	Description	Reference
00h	Vendor-specific (does not require mode page format)	-
01h	Read/Write Error Recovery mode page	7.3
03h	MRW mode page	7.4
05h	Write Parameter mode page	7.5
08h	Caching mode page	7.6
1Ah	Power Condition mode page	7.7
1Ch	Informational Exceptions Control Mode Page	7.8
1Dh	Time-out & Protect mode page	7.9

7.2.3 Mode Page Format

The general format of a mode page is shown in Table 647.

Table 647 — Mode Page Format

Bit	7	6	5	4	3	2	1	0
Byte								
0	PS/ Reserved	Reserved	Page Code					
1	Page Length (n – 1)							
2	Mode Parameters							
...								
N								

7.2.3.1 Parameters Savable bit (PS)

7.2.3.1.1 PS in the MODE SENSE Returned Data

When Parameters Savable (PS) bit is zero (0), the Drive does not support saving this mode page data.

7.2.3.1.2 PS in the MODE SELECT Parameter List

When using the MODE SELECT (10) command, the PS bit is reserved.

7.2.3.2 Page Code

The Page Code field identifies the format and parameters defined for the mode page.

7.2.3.2.1 Page Code in the MODE SENSE Returned Data

If the Drive implements Mode Page 00h (a vendor specific page) and the MODE SENSE (10) command is received with Page Code (CDB parameter) set to 3Fh (return all pages), then Mode Page 00h shall appear last in the returned data.

7.2.3.2.2 Page Code in the MODE SELECT Parameter List

The Host may specify a Page Code from any of the pages in Table 646. If the Drive does not support the page specified by the Page Code, then the command shall be terminated with CHECK CONDITION status and SK/ASC/ASCQ shall be set to ILLEGAL REQUEST/INVALID FIELD IN PARAMETER LIST.

7.2.3.3 Page Length

The Page Length field specifies the length in bytes of the mode parameters that follow.

7.2.3.3.1 Page Length in the MODE SENSE Returned Data

The Drive is permitted to implement a mode page that is less than the full-page length, provided no field is truncated and the Page Length field correctly specifies the actual length implemented.

7.2.3.3.2 Page Length in the MODE SELECT Parameter List

If the Host does not set this value to the value that is returned for the page by the MODE SENSE command, the Drive shall terminate the command with CHECK CONDITION status and SK/ASC/ASCQ values shall be set to ILLEGAL REQUEST/INVALID FIELD IN PARAMETER LIST.

7.2.4 Using Mode Parameters for MM Devices

Mode Pages described and required by Features shall be present if the Feature is reported by the Drive, regardless of whether or not the Feature is current. The current values and changeable masks shall not change, even across morphing. Default values may change when morphing occurs. Default values shall reflect a usable set of values for the loaded medium. Changes made by the Drive to the default values shall not generate a UNIT ATTENTION condition.

7.3 Read/Write Error Recovery Parameters Mode Page (Page Code 01h)

7.3.1 Introduction

The Read/Write Error Recovery Parameters Mode Page (Table 649) specifies the error recovery parameters the Drive shall use during any command that performs a data read or write operation from the media (e.g. READ, READ CD, WRITE, etc.).

Table 648 shows the Features associated with the Read/Write Error Recovery Mode Page.

Table 648 — Features Associated with the READ/WRITE Error Recovery Mode Page

Feature Number	Feature Name	Requirement
0010h	Random Readable	Mandatory when PP bit is 1.
0020h	Random Writable	Mandatory when PP bit is 1.
0024h	Hardware Defect Management	Mandatory
0025h	Write Once	Mandatory when PP bit is 1.
0029h	Enhanced Defect Reporting	Mandatory
0042h	TSR	Mandatory

7.3.2 The Mode Page and its Parameters

7.3.2.1 The Mode Page

Table 649 — Read/Write Error Recovery Parameters Mode Page Format

Bit Byte	7	6	5	4	3	2	1	0	
0	PS	Reserved	Page Code (01h)						
1	Page Length (0Ah)								
2	Error Recovery Behavior								
	AWRE	ARRE	TB	RC	Reserved	PER	DTE	DCR	
3	Read Retry Count								
4	Reserved								
5	Reserved								
6	Reserved								
7	Reserved						EMCDR		
8	Write Retry Count								
9	Error Reporting Window size								
10									(MSB)
11									(LSB)

7.3.2.2 PS

The Parameters Savable (PS) bit is defined in 7.2.3.1.

7.3.2.3 Page Code

The Page Code field shall be set to 01h, identifying the Read/Write Error Recovery Parameters Mode Page.

7.3.2.4 Page Length

The Page Length shall be set to 0Ah.

7.3.2.5 Error Recovery Behavior

7.3.2.5.1 Automatic Write Reallocation Enabled (AWRE)

The Automatic Write Reallocation Enabled bit (AWRE) shall be ignored when the Current bit of the Defect Management Feature descriptor is set to zero.

If AWRE bit is set to zero, the Drive shall not perform automatic reallocation of defective data blocks during write operations.

If AWRE is set to one, the Drive shall enable automatic reallocation of defective blocks during write operations. Error reporting as required by the error recovery bits (PER, DTE, and DCR) shall be performed only after completion of the reallocation.

If the media format is MRW, the Default value (as reported when CDB parameter PC = 10b) for AWRE is one (1b).

7.3.2.5.2 Automatic Read Reallocation Enabled (ARRE)

The Automatic Read Reallocation Enabled bit (ARRE) shall be ignored when the Current bit of the Defect Management Feature descriptor is set to zero.

If ARRE is set to zero, the Drive shall not perform automatic reallocation of defective data blocks during read operations.

If ARRE is set to one, the Drive shall enable automatic reallocation of defective data blocks during read operations. All error recovery actions required by the error recovery bits (TB, PER, DTE, and DCR) shall be processed. The automatic reallocation shall then be performed only if the Drive successfully recovers the data. Error reporting as required by the error recovery bits shall be performed only after completion of the reallocation. The reallocation process shall present any failures that occur. When ARRE is set to one, DCR and RC shall be each set to zero.

When media formatted as MRW is detected, the Default value (as reported when CDB parameter PC = 10b) of ARRE is zero. When DVD+RW media with the Basic Format is detected, the Default values for ARRE and AWRE (as reported when CDB parameter PC = 10b) shall be zero.

Support for ARRE = 1 is optional. It is recommended that MM Drives support only ARRE = 0.

7.3.2.5.3 Transfer Block (TB)

A transfer block (TB) bit of zero indicates that a data block that has not been successfully recovered shall not be transferred to the Host. A TB bit of one indicates that a data block that is not recovered within the recovery limits specified shall be transferred to the Host before CHECK CONDITION status is returned. The TB bit does not affect the action taken for recovered data.

7.3.2.5.4 Read Continuous (RC)

A Read Continuous (RC) bit of zero indicates that error recovery operations that cause delays are acceptable during the data transfer. The Drive shall assign priority to this bit over conflicting error control bits (EER, DCR, DTE, and PER) within this byte.

A RC bit of one indicates the Drive shall transfer the entire requested length of data without adding delays to perform error recovery procedures. This implies that the Drive may send data that is erroneous or fabricated in order to maintain a continuous flow of data. Fabricated data may be data already in the buffer or any other vendor-specific data. This bit may be used in image processing, audio, or video applications. A read continuous (RC) bit of zero indicates that error recovery operations that cause delays are acceptable during the data transfer.

7.3.2.5.5 Post Error (PER)

A Post Error (PER) bit controls recovered error reporting of Drive. This bit is used in conjunction with the EMCDR field if Drive supports Enhanced Defect Reporting Feature. The description of this bit is described in 7.3.2.7.1, "Description of PER bit and EMCDR field".

A Post Error (PER) bit of one indicates that the Drive shall report recovered errors. A PER bit of zero indicates that the Drive shall not report recovered errors. Error recovery procedures shall be performed within the limits established by the error recovery parameters. In order to enhance data recovery from DVD media, error correction shall always be enabled. Thus, PER shall not apply to error corrected data. This bit for DVD media shall only be used to report when auto reallocation of a logical block has been performed. For CD media this capability is used only to report when the Layered Error correction has been used to recover the data.

A Disable Transfer on Error (DTE) bit of one indicates that the Drive shall terminate the data transfer to the Host upon detection of a recovered error. A DTE bit of zero indicates that the Drive shall not terminate the data transfer upon detection of a recovered error.

A Disable Correction (DCR) bit of one indicates that error correction codes shall not be used for data error recovery. A DCR bit of zero allows the use of error correction codes for data error recovery. In order to enhance data recovery from DVD media, error correction shall always be enabled regardless of the setting of DCR.

7.3.2.5.6 Disable Transfer on Error (DTE)

A Disable Transfer on Error (DTE) bit of one indicates that the Drive shall terminate the data transfer to the Host upon detection of a recovered error. A DTE bit of zero indicates that the Drive shall not terminate the data transfer upon detection of a recovered error.

7.3.2.5.7 Disable Correction (DCR)

A Disable Correction (DCR) bit of one indicates that error correction codes shall not be used for data error recovery. A DCR bit of zero allows the use of error correction codes for data error recovery.

7.3.2.5.8 Error Recovery Cases for CD

An interpretation of the bits 5-0 in byte 2 for CD-ROM Drives is given in Table 650.

Table 650 — CD-ROM Devices, error recovery description

Error code	Description
00h	The maximum error recovery procedures available are used. If an error occurs that is uncorrectable with the error correction codes (ECC) on the media, data transfer is terminated with CHECK CONDITION status. The block with the error is not transferred. The sense key is set to MEDIUM ERROR. The information bytes give the address of the block where the un-recovered error was detected. Recovered errors are not reported.
01h	Only retries of the read operation and CIRC are used (layered error correction is not used). Only CIRC unrecovered data errors are reported. If a CIRC un-recovered data error occurs, data transfer is terminated with CHECK CONDITION status. The block with the error is not transferred. The sense key is set to MEDIUM ERROR. The information bytes give the address of the block where the un-recovered error was detected. Recovered errors are not reported.
04h	The maximum error recovery procedures available are used. Recovered data errors are reported. If a recovered data error occurs, data transfer is not terminated. However, when the data transfer has completed CHECK CONDITION status is reported. The sense key is set to RECOVERED ERROR. The information bytes give the address of the last block where a recovered data error was detected. If a data error occurs that is uncorrectable with the ECC information available on the media, data transfer is terminated and CHECK CONDITION status is reported. The block with the error is not transferred. The sense key is set to MEDIUM ERROR. The information bytes give the address of the block where the uncorrectable error was detected.
05h	Only retries of the read operation and CIRC are used (layered error correction is not used). Recovered data errors are reported. If a recovered data error occurs, data transfer is not terminated. However, when the data transfer has completed CHECK CONDITION status is reported. The sense key is set to RECOVERED ERROR. The information bytes give the address of the last block where a CIRC recovered data error was detected. If an un-recovered data error occurs, data transfer is terminated and CHECK CONDITION status is reported. The block with the error is not transferred. The sense key is set to MEDIUM ERROR. The information bytes give the address of the block where the un-recovered error was detected.
06h	The maximum error recovery procedures are used. Recovered data errors are reported. If a recovered data error occurs data transfer is terminated and CHECK CONDITION status is reported. The block with the recovered error is not transferred. The sense key is set to RECOVERED ERROR. The information bytes give the address of the block where the recovered data error was detected. If a data error occurs that is uncorrectable with the ECC information on the medium, data transfer is terminated with CHECK CONDITION status. The block with the error is not transferred. The sense key is set to MEDIUM ERROR. The information bytes give the address of the block where the uncorrectable error was detected.

Table 650– CD-ROM Devices, error recovery description (cont.)

Error Code	Description
07h	<p>Only retries of the read operation are used (layered error correction is not used). CIRC recovered data errors are reported. If a CIRC recovered data error occurs, data transfer is terminated with CHECK CONDITION status. The block with the recovered error is not transferred. The sense key is set to RECOVERED ERROR. The information bytes give the address of the block where the recovered data error was detected.</p> <p>If an CIRC un-recovered data error occurs, data transfer is terminated with CHECK CONDITION status. The block with the error is not transferred. The sense key is set to MEDIUM ERROR. The information bytes give the address of the block where the uncorrectable error was detected.</p>
10h	<p>If it is possible to maintain data transfer, the maximum error recovery procedures available are used. (RC=1.) If an error occurs that is uncorrectable with the error codes (ECC) on the media, or is uncorrectable in time to maintain data transfer, the data transfer is not terminated. However, when the data transfer has completed, CHECK CONDITION status is reported. The sense key is set to MEDIUM ERROR. The information bytes give the address of the block where the first un-recovered error was detected. Recovered errors are not reported.</p>
11h	<p>If it is possible to maintain data transfer, retries of the read operation and CIRC are used (layered error correction is not used). (RC=1.) Only CIRC un-recovered data errors are reported. If a CIRC un-recovered data error occurs, data transfer is not terminated. However, when data transfer has completed, CHECK CONDITION status is reported. The sense key is set to MEDIUM ERROR. The information bytes give the address of the block where the first un-recovered error was detected. Recovered errors are not reported.</p> <p>If a data error occurs that is uncorrectable with the ECC information available on the media, data transfer is terminated and CHECK CONDITION status is reported. The block with the error is not transferred. The sense key is set to MEDIUM ERROR. The information bytes give the address of the block where the uncorrectable error was detected.</p>
14h	<p>If it is possible to maintain data transfer, the maximum error recovery procedures available are used. (RC=1.) Recovered data errors are reported. If a recovered data error occurs, data transfer is not terminated. However, when the data transfer has completed, CHECK CONDITION status is reported. The sense key is set to RECOVERED ERROR. The information bytes give the address of the block where a recovered data error was detected.</p> <p>If an data error occurs that is uncorrectable with the ECC information available on the media, or is uncorrectable in time to maintain data transfer, the data transfer is not terminated. However, when the data transfer has completed, CHECK CONDITION status is reported. The sense key is set to MEDIUM ERROR. The information bytes give the address of the block where the first un-recovered error was detected. Reporting un-recovered errors takes precedence over reporting recovered errors.</p>
15h	<p>If it is possible to maintain data transfer, retries of the read operation and CIRC are used (layered error correction is not used). (RC=1.) Recovered data errors are reported. If a recovered data error occurs, data transfer is not terminated. However, when the data transfer has completed CHECK CONDITION status is reported. The sense key is set to RECOVERED ERROR. The information bytes give the address of the block where a CIRC recovered data error was detected.</p> <p>If an un-recovered data error occurs, data transfer is not terminated. However, when the data transfer has completed CHECK CONDITION status is reported. The sense key is set to MEDIUM ERROR. The information bytes give the address of the block where the un-recovered error was detected. Recovered errors are not reported.</p>
20h	<p>The maximum error recovery procedures available are used. If an error occurs that is uncorrectable with the error correction codes (ECC) on the media, data transfer is terminated with CHECK CONDITION status. The block with the error is transferred. The sense key is set to MEDIUM ERROR. The information bytes give the address of the block where the un-recovered error was detected. Recovered errors are not reported.</p>

Table 650– CD-ROM Devices, error recovery description (cont.)

Error Code	Description
21h	Only retries of the read operation and CIRC are used (layered error correction is not used). Only CIRC un-recovered data errors are reported. If an CIRC un-recovered data error occurs, data transfer is terminated with CHECK CONDITION status. The block with the error is transferred. The sense key is set to MEDIUM ERROR. The information bytes give the address of the block where the un-recovered error was detected. Recovered errors are not reported.
24h	The maximum error recovery procedures available are used. Recovered data errors are reported. If a recovered data error occurs, data transfer is not terminated. However, when the data transfer has completed, CHECK CONDITION status is reported. The sense key is set to RECOVERED ERROR. The information bytes give the address of the last block where a recovered data error was detected. If a data error occurs that is uncorrectable with the ECC information available on the media, data transfer is terminated and CHECK CONDITION status is reported. The block with the error is transferred. The sense key is set to MEDIUM ERROR. The information bytes give the address of the block where the uncorrectable error was detected.
25h	Only retries of the read operation and CIRC are used (layered error correction is not used). Recovered data errors are reported. If a recovered data error occurs, data transfer is not terminated. However, when the data transfer has completed CHECK CONDITION status is reported. The sense key is set to RECOVERED ERROR. The information bytes give the address of the last block where a CIRC recovered data error was detected. If an un-recovered data error occurs, data transfer is terminated and CHECK CONDITION status is reported. The block with the error is transferred. The sense key is set to MEDIUM ERROR. The information bytes give the address of the block where the un-recovered error was detected.
26h	The maximum error recovery procedures are used. Recovered data errors are reported. If a recovered data error occurs data transfer is terminated and CHECK CONDITION status is reported. The block with the recovered error is transferred. The sense key is set to RECOVERED ERROR. The information bytes give the address of the block where the recovered data error was detected. If a data error occurs that is uncorrectable with the ECC information on the medium, data transfer is terminated with CHECK CONDITION status. The block with the error is transferred. The sense key is set to MEDIUM ERROR. The information bytes give the address of the block where the uncorrectable error was detected.
27h	Only retries of the read operation are used (layer error correction is not used). CIRC recovered data errors are reported. If a CIRC recovered data error occurs, data transfer is terminated with CHECK CONDITION status. The block with the recovered error is transferred. The sense key is set to RECOVERED ERROR. The information bytes give the address of the block where the recovered data error was detected. If a CIRC un-recovered data error occurs, data transfer is terminated with CHECK CONDITION status. The block with the error is transferred. The sense key is set to MEDIUM ERROR. The information bytes give the address of the block where the un-recovered error was detected.
30h	Same as code 10h
31h	Same as code 11h
34h	Same as code 14h
35h	Same as code 15h

7.3.2.5.9 Error Recovery Cases for DVD

An interpretation of the bits 5-0 in byte 2 for DVD-ROM Drives is given in Table 651.

Table 651 — DVD Devices, Error Recovery Description

Code	Error Recovery Description
00h	The maximum error recovery procedures available are used. If an error occurs that is uncorrectable with the error correction codes (ECC) on the media, data transfer is terminated with CHECK CONDITION status. The block with the error is not transferred. The sense key is set to MEDIUM ERROR. The information bytes give the address of the block where the un-recovered error was detected. Recovered errors are not reported.
04h	The maximum error recovery procedures available are used. Recovered data errors are reported. If a recovered data error occurs, data transfer is not terminated. However, when the data transfer has completed CHECK CONDITION status is reported. The sense key is set to RECOVERED ERROR. The information bytes give the address of the last block where a recovered data error was detected. If a data error occurs that is uncorrectable with the ECC information available on the media, data transfer is terminated and CHECK CONDITION status is reported. The block with the error is not transferred. The sense key is set to MEDIUM ERROR. The information bytes give the address of the block where the uncorrectable error was detected. The only possible recovered errors are when a block is automatically reassigned using ARRE.
10h	If it is possible to maintain data transfer, the maximum error recovery procedures available are used. (RC = 1.) If an error occurs that is uncorrectable with the error correction codes (ECC) on the media, or is uncorrectable in time to maintain data transfer, the data transfer is not terminated. However, when the data transfer has completed, CHECK CONDITION status is reported. The sense key is set to MEDIUM ERROR. The information bytes give the address of the block where the first unrecovered error was detected. Recovered errors are not reported.
20h	The maximum error recovery procedures available are used. If an error occurs that is uncorrectable with the error correction codes (ECC) on the media, data transfer is terminated with CHECK CONDITION status. The block with the error is transferred. The sense key is set to MEDIUM ERROR. The information bytes give the address of the block where the un-recovered error was detected. Recovered errors are not reported.
24h	The maximum error recovery procedures available are used. Recovered data errors are reported. If a recovered data error occurs data transfer is not terminated. However, when the data transfer has completed, CHECK CONDITION status is reported. The sense key is set to RECOVERED ERROR. The information bytes give the address of the last block where a recovered data error was detected. If a data error occurs that is uncorrectable with the ECC information available on the media data transfer is terminated and CHECK CONDITION status is reported. The block with the error is transferred. The sense key is set to MEDIUM ERROR. The information bytes give the address of the block where the uncorrectable error was detected. The only possible recovered errors are when a block is automatically reassigned using ARRE.

7.3.2.6 Read Retry Count

The Read Retry Count field specifies the number of times that the Drive shall attempt its read recovery algorithm.

7.3.2.7 Enhanced Media Certification and Defect Reporting (EMCDR)

The Enhanced Media Certification and Defect Reporting (EMCDR) field controls medium certification and error reporting of Drive. This field is used in conjunction with PER bit. Host should set this field to 0 if Drive does not support Enhanced Defect Reporting feature. The description of this bit is described in 7.3.2.7.1.

7.3.2.7.1 Description of PER bit and EMCDR field

Description of PER bit and EMCDR field is different if Enhanced Defect Reporting Feature is supported and is current. Following sub-clause 7.3.2.7.2 and 7.3.2.7.3 describe the description. By the setting PER bit and EMCDR field to 0, DBI data shall not be cleared.

7.3.2.7.2 In case of Enhanced Defect Reporting Feature is not supported or is not current

If the Drive does not support Enhanced Defect Reporting Feature, Host should set EMCDR field to 0.

If the Drive supports Enhanced Defect Reporting Feature and Enhanced Defect Reporting Feature is not current, Drive shall ignore the EMCDR field setting.

A Post Error (PER) bit of one indicates that the Drive shall report recovered errors. A PER bit of zero indicates that the Drive shall not report recovered errors. Error recovery procedures shall be performed within the limits established by the error recovery parameters. This capability is very different for DVD media. To be able to recover the data from DVD media, error correction shall be used. Thus it is not reasonable to report when ECC is used to recover the data. This bit for DVD-RAM media shall only be used to report when auto reallocation of a logical block has been performed.

For CD media this capability is used to report when the Layered Error correction has been used to recover the data.

Again as the CIRC is mandatory for recovery of data, then CIRC Recovered Data Error is defined as follows.

A CIRC Recovered Data Error is defined as a block for which the CIRC based error correction algorithm was unsuccessful for a read attempt, but on a subsequent read operation no error was reported. The number of subsequent read operations is limited to the read retry count. Layered error correction was not used.

A CIRC Unrecovered Data Error is defined as a block for which the CIRC based error correction algorithm was unsuccessful on all read attempts up to the Read Retry count. Layered error correction was not used.

An L-EC Recovered Data Error is defined as a block for which the CIRC based error correction algorithm was unsuccessful, but the layered error correction was able to correct the block within the read retry count.

An L-EC Uncorrectable Data Error is defined as a block that was not corrected by layered error correction within the Read Retry count.

7.3.2.7.3 In case of Enhanced Defect Reporting Feature is current

When Enhanced Defect Reporting Feature is supported and is current, Drive behavior is described in 4.7. The relationship of PER and EMCDR is shown in Table 652.

Table 652 — Relationship of PER and EMCDR when Enhanced Defect Reporting Feature is current

PER	EMCDR	Drive Responses
0	0	Drive shall not certify medium on read operation and shall not report recovered error
	1	Drive shall certify medium on read operation and verify operation, and shall not report recovered error
	2	Drive shall certify medium on read operation and verify operation, and shall report recovered error or unrecovered error on verify operation.
	3	Drive shall certify medium on read operation and verify operation, and shall report recovered error or unrecovered error on read operation and verify operation
1	0	Behavior is described in 7.3.2.7.2
	1	Certify medium on read operation and verify operation. Recovered errors shall be reported as RECOVERED ERROR/RECOVERED DATA – RECOMMEND REASSIGNMENT.
	2	
	3	

7.3.2.8 Write Retry Count

The Write Retry Count field specifies the number of times that the Drive shall attempt its write recovery algorithm.

7.3.2.9 Error Reporting Window size

The Error Reporting Window size field specifies the threshold length for error reporting. It is a count of logical blocks. A defect found during the execution of a write command, or read command, or verification of a writable unit including the LBA of the previously mentioned write command, shall be reported before or when this count of logical block has been transmitted by the host through write commands. The defect may be reported earlier but shall not be reported later. If a write command would cause the count of logical block to be exceeded and a defect has already been found but not reported, the write command shall be terminated with CHECK CONDITION status and sense bytes SK/ASC/ASCQ shall be set to NOT READY/WRITE ERROR RECOVERY NEEDED. The host shall issue again the write command that did cause the count of logical block to be exceeded after reading the defect information from the Drive using GET PERFORMANCE command with Type=02h (Defect Status data). If a write command would cause the count of logical block to be exceeded but writing or verification of buffered write commands has not been performed, the write command shall be terminated with CHECK CONDITION status and sense bytes SK/ASC/ASCQ shall be set to NOT READY/LONG WRITE IN PROGRESS. The Drive shall then proceed with cache writing and or verification.

A value of 0h means that TSR method is not supported. If TSR method is supported, the threshold's length shall be strictly bigger than the buffer reported by the Drive to READ BUFFER CAPACITY. A threshold length which allows enough delay between the write pass and the verify pass so that write to verify and verify to write transition time is negligible compared to the write time for the threshold length is recommended. If the Drive does not support interruption of verify pass during phase one to proceed incoming commands, it should not allow a threshold length longer than **is possible to** verify without causing a timeout.

The host may keep the default threshold length or may increase or decrease the threshold length by MODE SELECT. If the value set by the host is not supported, it shall be rounded by the Drive to the nearest smaller threshold supported. The host shall check the selected value using MODE SENSE.

The host shall not change the error reporting threshold during phase one. The Drive shall fail, with CHECK CONDITION and sense bytes SK/ASC/ASCQ shall be set to ILLEGAL REQUEST/ COMMAND SEQUENCE ERROR, any change attempt after the first TSR write has been issued and when no synchronize cache command has yet being issued to signal the end of the phase.

7.4 MRW Mode Page (Page Code 03h)

7.4.1 Introduction

The MRW Mode Page (Table 654) provides a method by which the Host may control the special features of a MRW CD-RW Drive.

Table 653 shows the Features associated with the MRW Mode Page.

Table 653 — Features Associated with the MRW Mode Page

Feature Number	Feature Name	Requirement
0028h	MRW	Mandatory

7.4.2 The Mode Page and its Parameters

7.4.2.1 The Mode Page

Table 654 — MRW Mode Page

Bit	7	6	5	4	3	2	1	0
Byte								
0	PS	Resvd	Page Code (03h)					
1	Page Length (06h)							
2	Reserved							
3	Reserved							LBA Space
4	Reserved							
5	Reserved							
6	Reserved							
7	Reserved							

7.4.2.2 PS

The Parameters Savable (PS) bit is defined in 7.2.3.1.

7.4.2.3 Page Code

The Page Code field shall be set to 03h, identifying the MRW Mode Page.

Note 31. This mode page may be implemented as Page Code 2Ch, a vendor unique code. Use of Page Code 2Ch is obsolete. In order to avoid compatibility problems, it is recommended that both Drives and Hosts implement both codes.

7.4.2.4 Page Length

The Page Length shall be set to 06h.

7.4.2.5 LBA Space

If the currently mounted medium is a MRW disc, then the value of LBA Space defines the current address space available to the Host. If LBA Space is set to 0, the Drive shall reference the DMA for all LBA space reads and writes. If LBA Space is set to 1, the Drive shall reference the GAA for all LBA space reads and writes.

After power-on, any reset, or a medium change, the LBA Space value shall be set to zero. This assures that the default LBA Space is always the DMA.

Whenever Host changes the LBA Space bit, the Drive shall generate an Operational Change Event to indicate that the currency of features has changed (e.g. Hardware Defect Management).

All commands that refer to the LBA space of the medium is restricted to the LBA space selected by this mode page.

7.5 Write Parameters Mode Page (Page Code 05h)

7.5.1 Introduction

The Write Parameters Mode Page (Table 656) provides parameters that are often needed in the execution of commands that write to the media. After power-on or hard reset, the Drive shall assign default values according to some supported medium.

Table 655 shows the Features associated with the Write Parameters Mode Page.

Table 655 — Features Associated with the Write Parameters Mode Page

Feature Number	Feature Name	Requirement
0021h	Incremental Streaming Writable	Mandatory
0026h	Restricted Overwrite	Mandatory
0027h	CD-RW CAV Write	Mandatory
002Dh	CD Track-At-Once	Mandatory
002Eh	CD Mastering (Both SAO and Raw)	Mandatory
002Fh	DVD-R/-RW Write Feature	Mandatory

7.5.2 Applicable Media

This mode page is useful for CD-R, CD-RW (not MRW formatted), DVD-R, and DVD-RW media.

For DVD-RW media, if a medium is in Sequential recording mode, usage of this mode page shall conform to descriptions for DVD-R unless otherwise specified. If a medium is in Restricted overwrite mode, this mode page shall not be used.

The values in this page do not necessarily reflect the status on a given medium.

If any parameter value is incompatible with the current medium, the Drive shall terminate any write type command with CHECK CONDITION status and set SK/ASC/ASCQ values to ILLEGAL REQUEST/ILLEGAL MODE FOR THIS TRACK. Fields not required or ignored for the current medium may contain 0 for the default mode parameter value.

7.5.3 Exempted Media

The parameters specified in this mode page are not applicable to DVD-RAM, DVD+R, DVD+RW, all recordable BD, all recordable HD DVD and any media that is formatted as MRW. When any of these media is mounted and recognized by the Drive, it shall set write speed and internal write parameters as needed to properly access the medium. This shall be done without Host intervention. Furthermore, the Drive shall not modify the current parameters of the Write Parameters Mode Page.

If the Host changes the Write Parameters Mode Page, operation with the medium shall not be affected. When a CD-RW disc is mounted that does not have the MRW format and a FORMAT UNIT command is sent for the purpose of formatting the disc as MRW, the same rule applies. Specifically, the Host is not required to set the Write Parameters Mode Page prior to sending the FORMAT UNIT command when specifying format type 24h (MRW). Furthermore, the Drive shall not alter current the Write Parameters Page in performing the format.

7.5.4 The Mode Page and its Parameters

7.5.4.1 The Mode Page

The mode page format is shown in Table 656.

Table 656 — Write Parameters Page

Bit Byte	7	6	5	4	3	2	1	0
0	PS	Reserved	Page Code (05h)					
1	Page Length (32h or 36h)							
2	Reserved	BUFE	LS_V	Test Write	Write Type			
3	Multi-session		FP	Copy	Track Mode			
4	Reserved				Data Block Type			
5	Link Size							
6	Reserved							
7	Reserved		Host Application Code					
8	Session Format							
9	Reserved							
10	(MSB) Packet Size (LSB)							
11								
12								
13								
14	(MSB) Audio Pause Length (LSB)							
15								
16	(MSB) Media Catalog Number (LSB)							
...								
31								
32								
...	(MSB) International Standard Recording Code (LSB)							
47								
48								
49	Sub-header Byte 1							
50	Sub-header Byte 2							
51	Sub-header Byte 3							
52 – 55	Vendor Specific							

7.5.4.2 PS

The Parameters Savable (PS) bit is defined in 7.2.3.1.

7.5.4.3 Page Code

The Page Code field shall be set to 05h, identifying the Write Parameters Mode Page.

7.5.4.4 Page Length

The Page Length shall be set to either 32h or 36h, depending upon support for the Vendor Specific field.

7.5.4.5 BUFE

The meaning and use of the BUFE (Buffer Under-run Free recording enable) bit is described in Table 657.

Table 657 — Use of BUFE bit

Drive action with BUFE bit as applied to...		
CD-R and CD-RW	0	Buffer Under-run Free recording is disabled. When performing sequential recording and Drive's write buffer becomes empty, it shall perform linking and terminate writing.
	1	Buffer Under-run Free recording is enabled for sequential recording. The Drive shall perform zero-loss linking and continue writing when the buffer becomes non-empty.
DVD-RAM, DVD+R and DVD+RW	0	The setting of BUFE has no meaning for either DVD-RAM, DVD+R or DVD+RW media and shall be ignored.
	1	
DVD-R and DVD-RW	0	Buffer Under-run Free recording is disabled. When performing sequential recording and Drive's write buffer becomes empty, it shall perform linking and terminate writing.
	1	Buffer Under-run Free recording is enabled for sequential recording. The Drive shall perform zero-loss linking and continue writing when the buffer becomes non-empty.

7.5.4.6 LS_V

If the LS_V (Link Size Valid) bit is set to one, the value in the Link Size field is valid. If the LS_V bit is set to zero, the Link Size field shall be assumed to contain 7.

7.5.4.7 Link Size

The Link Size field specifies the Linking Loss area size in sectors. The Link Size field is valid only for Write Type "Packet/Incremental." When another Write Type is specified, the Drive shall ignore both LS_V bit and Link Size field. The Drive shall accept values that are valid for the Drive but not valid for the current medium. If writing is attempted when an invalid Link Size is set, the Drive shall generate CHECK CONDITION status and set SK/ASC/ASCQ values to ILLEGAL REQUEST/ILLEGAL MODE FOR THIS TRACK.

7.5.4.8 Test Write

On CD-R/RW media the Test Write bit is valid only for Write Type 1 or 2 (Track at Once or Session at Once).

On DVD-R media, the Test Write bit is valid only for Write Type 0 or 2 (Incremental or Disc-at-once). When the Test Write bit is set to one, it indicates that the device performs the write process, but does not write data to the media. When the bit is set to zero the Write laser power is set such that user data is transferred to the media. In addition, all track and disc information collected, during test write mode, shall be cleared. It should be noted that the number of tracks reserved or written may be limited in test write mode.

7.5.4.9 Write Type

Write Type Field (Table 658) specifies the stream type to be used during writing.

Table 658 — Write Type Field

Field Value	Write Type	Description
00h	Packet/ Incremental	The device shall perform Packet/Incremental writing when WRITE commands are issued.
01h	Track At Once	The device shall perform Track At Once recording when write commands are issued.
02h	Session At Once	The device shall perform Session At Once recording. For CD, this mode requires that a cue sheet be sent prior to sending write commands.
03h	RAW	The device shall write data as received from the Host. In this mode, the Host sends the Lead-in. The Host should provide Q Sub-channel in this mode, the only valid Data Block Types are 1, 2, and 3. The Next Writable Address starts at the beginning of the Lead-in (this shall be a negative LBA on a blank disc). In RAW record mode the Drive shall not generate run-in and run-out blocks (main and Sub-channel 1 data) but shall generate and record the link block. Write Type of Track-at-once and RAW are invalid when DVD-R media is present.
04h	Layer Jump Recording	The Drive shall perform Layer Jump recording when WRITE (10) commands are issued. When this write type is specified, regardless of BUFE bit setting, Buffer Underrun Error Free recording shall be performed.
05h - FFh	Reserved	—

The Multi-session field defines how session closure affects the opening of the next session. See Table 659.

Table 659 — Multi-session Field Definition

Multi-session Field	Action Upon Session Closure
00b	For CD, No B0 pointer. Next Session not allowed. For DVD-R/-RW, next Border not allowed. When current Border is closed, Lead-out shall be appended after the last Border-out. In the case of DVD-R media, the Next Border Marker in last Border-out shall be padded with 00h bytes and shall have the Lead-out attribute set.
01b	For CD media, B0 pointer = FF:FF:FF. Next session not allowed. Reserved for DVD-R/-RW
10b	Reserved
11b	For CD, next session is allowed. B0 pointer = next possible program area. For DVD, Next Border is allowed. Lead-out shall not be appended after the last Border-out.

7.5.4.10 FP

The FP bit, when set to one indicates that the packet type is fixed. Otherwise, the packet type is variable. This bit is ignored unless the write type is set to 0 (Packet). For DVD-R/-RW, this bit shall default to one.

7.5.4.11 Copy

When the media is CD and Copy is set to one, SCMS recording is enabled. During recording, the copyright bit in the control nibble of each mode 1 Q Sub-channel shall alternate between 1 and 0 at 9.375 Hz. The duty cycle is 50%, changing every 4 blocks. The initial value on the medium is zero.

When Copy is zero, SCMS recording is disabled.

When the media is DVD-R/-RW, Copy is reserved.

7.5.4.12 Track Mode

On CD, Track Mode is the Control nibble in all Mode 1 Q Sub-channel in the track. For DVD-R/-RW, the default value should be 5.

7.5.4.13 Data Block Type

Data Block Type defines both the specific data fields in a user data block and its size. The Data Block Type codes are defined in Table 660. This size is used for writing instead of the block size set in the mode select header.

The default value of this field for CD-R/RW Drives shall be 8.

The default value of this field for DVD-R Drives shall be 8.

Table 660 — Data Block Type Codes (CD)

Value	Block Size	Definition	Requirement
0	2 352	Raw data 2 352 bytes of raw data (not valid for write type = packet)	Optional
1	2 368	Raw data with P and Q Sub-channel 2 352 bytes of raw data, 16 bytes for P & Q Sub-channel (see Table 364): Bytes 0..9 are Q Sub-channel data Bytes 10..11 are Q Sub-channel EDC Bytes 12..14 are zero Byte 15, most significant bit has state of P Sub-channel bit (not valid for write type = packet)	Optional
2	2 448	Raw data with P-W Sub-channel appended: 2 352 bytes of raw data. 96 bytes of pack form R-W Sub-channel in the low order 6 bits of each byte. Bit 7 of each byte contains the P Sub-channel state and bit 6 of each byte contains the Q Sub-channel bit. (not valid for write type = packet)	Optional
3	2 448	Raw data with raw P-W Sub-channel appended: 2 352 bytes of raw data. 96 bytes of raw P-W Sub-channel. (not valid for write type = packet)	Optional
4 – 6		Reserved values	
7	NA	Vendor Specific	Optional
8	2 048	Mode 1 (ISO/IEC 10149): 2 048 bytes of user data	Mandatory
9	2 336	Mode 2 (ISO/IEC 10149): 2 336 bytes of user data.	Optional
10	2 048	Mode 2 (CD-ROM XA, form 1): 2 048 bytes of user data, sub-header from write parameters.	Mandatory
11	2 056	Mode 2 (CD-ROM XA, form 1): 8 bytes of sub-header, 2 048 bytes of user data	Optional
12	2 324	Mode 2 (CD-ROM XA, form 2): 2 324 bytes of user data. Sub-header is taken from write parameters.	Optional
13	2 332	Mode 2 (CD-ROM XA, form 1, form 2, or mixed form): 8 bytes of sub-header 2 324 bytes of user data	Mandatory
14	-	Reserved values	
15	NA	Vendor Specific	Optional

The Drive shall automatically generate CD frame data according to the following:

1. When a track has been designated for packet writing, the device shall ensure that the TDB is written upon receipt of the first write command for the track.
2. With the exceptions of data block types 1, 2, and 3, the device shall generate all P Sub-channel and all mode 1, mode 2, and mode 3 Q Sub-channel.
3. For data block types 8 through 13, the device shall generate all sync fields and all headers.
4. When the data blocks are mode 1 or mode 2, form 1, the device shall generate EDC and L-EC parity.
5. For data block types 0, 1, 2, and 3, the device shall perform no data scrambling per ISO/IEC 10149.
6. For data block types 8 through 13, the device shall perform data scrambling per ISO/IEC 10149.

7.5.4.14 Host Application Code

In the case of CD, the Host Application Code field typically has the value zero. When the unrestricted Use Disc bit in the Disc Information Block (Table 372) is set to one, the Host Application Code field shall be ignored by the device. If the Unrestricted Use Disc bit is zero, then the Host Application Code shall be set to the appropriate value for the medium in order that writing is allowed. A Host Application Code of zero is used for a Restricted Use – General Purpose Disc.

On DVD-R/-RW, Host Application code is ignored.

7.5.4.15 Session Format Code

The Session Format code is to be written in the TOC of the session containing this track. The Session Format code is the PSEC byte of the mode 1, point A0 TOC entry.

Table 661 — Session Format Codes

Session Format Codes	Session Format
00h	CD-DA, or CD-ROM or other data discs
10h	CD-I Disc
20h	CD-ROM XA Disc
All Other Values	Reserved

7.5.4.16 Packet Size

If FP bit is set to one, the Packet Size field specifies the number of User Data Blocks per fixed packet. If FP bit is set to 0, the Packet Size field shall be ignored. For DVD-R/-RW media, the default Packet Size shall be 16.

7.5.4.17 Audio Pause Length

Audio Pause Length is applicable only to CD and shall be ignored for all other media types. Audio Pause Length is the number of blocks from the beginning of the track that the mode 1 Q Sub-channel INDEX shall be zero. If this number is zero, then there is no period where the Mode 1 Q Sub-channel INDEX shall be zero. The default value shall be 150. This field is valid only for audio tracks, otherwise it is ignored.

7.5.4.18 Media Catalog Number (MCN)

The Media Catalog Number (MCN) is valid only for writable CD media. This field shall be ignored for other media types. The MCN shall be written in the mode 2 Q Sub-channel in at least one out of every 100 blocks in the program area. MCN in the Write Parameters Mode Page is formatted as in Table 662. MCVAl is the MCN valid flag. If MCVAl is zero, then the content of bytes 17 through 31 shall be ignored. If MCVAl is one, the bytes 17 through 31 contain a valid MCN. The MCN digits are ASCII representations of decimal digits (30h through 39h). The Host may specify the content of bytes Zero and AFRAME; however, the Drive shall ignore these bytes and insert the appropriate values.

Table 662 — Media Catalog Number Format

Bit Byte	7	6	5	4	3	2	1	0
16	MCVAL	Reserved						
17	MCN digit N1 (Most significant)							
18	MCN digit N2							
...	...							
28	MCN digit N12							
29	MCN digit N13 (Least significant)							
30	Zero							
31	AFRAME							

7.5.4.19 International Standard Recording Code (ISRC)

The International Standard Recording Code (ISRC) is valid only for Writable CD media. This field shall be ignored when other media types are present. The ISRC shall be written in the mode 3 Q Sub-channel in at least one out of every 100 blocks in the track. The ISRC in the Write Parameters Mode Page is formatted as in Table 663.

Table 663 — International Standard Recording Code Format

Bit Byte	7	6	5	4	3	2	1	0	
32	TCVAL	Reserved							
33	Country Code:						I1		
34							I2		
35	Owner Code:						I3		
36							I4		
37							I5		
38	Year of Recording:						I6		
39							I7		
40	Serial Number:						I8		
41							I9		
42							I10		
43							I11		
44							I12		
45	Zero								
46	AFRAME								
47	Reserved								

Sub-header bytes 0 through 3 contain sub-header bytes to be used when recording CD-R/-RW with Data Block Types 10 and 12.

The Vendor Unique field should be ignored if the Drive does not support this field.

7.6 Caching Mode Page (08h)

7.6.1 Introduction

The caching parameters page defines the parameters that affect the use of the cache.

7.6.2 The Mode Page and its Parameters

7.6.2.1 The Mode Page

Table 664 — Caching mode page Format

Bit Byte	7	6	5	4	3	2	1	0
0	PS	Reserved	Page Code (08h)					
1	Page Length (0Ah)							
2	Reserved					WCE	Reserved	RCD
3	Reserved							
...								
11								

7.6.2.2 PS

The Parameter Savable bit is defined in 7.2.3.1.

7.6.2.3 Page Code

The Page Code is set to 08h, identifying the Caching mode page.

7.6.2.4 Page Length

Page Length shall be set to 0Ah.

7.6.2.5 WCE (Write Cache Enable)

A Write Cache Enable (WCE) bit of zero specifies that the Drive shall return GOOD status for a WRITE command after successfully writing all of the data to the medium. A WCE bit of one specifies that the Drive may return GOOD status for a WRITE command after successfully receiving the data and prior to having successfully written it to the medium.

7.6.2.6 RCD (Read Cache Disable)

A read cache disable (RCD) bit of zero specifies that the Drive may return data requested by a READ command by accessing either the cache or media. A RCD bit of one specifies that the Drive shall transfer all of the data requested by a READ command from the medium (i.e., data shall not be transferred from the cache).

7.7 Power Condition mode page (Page Code 1Ah)

The Power Condition mode page provides the Host with a means to control the length of time a Drive delays before changing its power requirements. There are notification events to the Host that a Drive has changed power conditions.

On the receipt of a command the Drive shall adjust itself to the power condition that allows the command to process. The timer that maps to this power condition and any lower power condition timers shall be reset on receipt of the command. On completion of the command the timer associated with this power condition shall be restarted.

Table 665 shows the Features associated with the Power Condition mode page.

Table 665 — Features Associated with the Power Condition mode page

Feature Number	Feature Name	Requirement
0100h	Power Management	Mandatory

The Power Condition Mode Page is described in [SPC-3].

7.8 Informational Exceptions Control Mode Page (Page Code 1Ch)

The Informational Exceptions Control Mode Page defines the methods used by the target to control the reporting and the operations of specific informational exception conditions. This page shall only apply to informational exceptions when CHECK CONDITION status is reported and ASC set to FAILURE PREDICTION THRESHOLD EXCEEDED to the Host.

Note 32. This mode page was named the Fault/Failure Reporting Control page in earlier versions of this standard. The name has been changed in order to be consistent with [SPC-3].

Informational exception conditions occur as a result of vendor specific events within a target. An informational exception condition may occur asynchronous to any commands issued by A Host.

Table 666 shows the Features associated with the Informational Exceptions Control mode page.

Table 666 — Features Associated with the Informational Exceptions Control mode page

Feature Number	Feature Name	Requirement
0101h	SMART	Mandatory when PP bit = 1

The Informational Exceptions Control Mode Page is described in [SPC-3].

7.9 Timeout and Protect Page (Page Code 1Dh)

7.9.1 Introduction

The Timeout and Protect page (Table 668) specifies parameters that affect Drive operation.

Table 667 shows the Features associated with the Timeout and Protect Page.

Table 667 — Features Associated with the Timeout and Protect Page

Feature Number	Feature Name	Requirement
0105h	Timeout	Mandatory

7.9.2 The Mode Page and its Parameters

7.9.2.1 The Mode Page

Table 668 — Timeout & Protect Page

Bit Byte	7	6	5	4	3	2	1	0
0	PS	Reserved	Page Code (1Dh)					
1	Page Length (0Ah)							
2	Reserved							
3	Reserved							
4	Reserved				G3Enable	TMOE	DISP	SWPP
5	Reserved							
6	(MSB)	Group 1 Minimum Timeout (Seconds)						(LSB)
7								
8	(MSB)	Group 2 Minimum Timeout (Seconds)						(LSB)
9								
10	(MSB)	Group 3 Time-out (100 milliseconds)						(LSB)
11								

7.9.2.2 PS

The Parameters Savable (PS) bit is defined in 7.2.3.1.

7.9.2.3 Page Code

The Page Code field shall be set to 1Dh, identifying the Timeout and Protect Page.

7.9.2.4 Page Length

The Page Length shall be set to 08h.

7.9.2.5 G3Enable

G3Enable bit, when set to one, enables the Group 3 timeout capability. A G3Enable bit of zero disables the Group 3 timeout capability. In order to minimize compatibility problems, the default value for G3Enable bit should be set to zero.

7.9.2.6 TMOE

The Timeout Enable bit (TMOE), when set to one, enables reporting a Group 1 Timeout as an error: UNIT ATTENTION/INSUFFICIENT TIME FOR OPERATION and the Command Specific Information field of the sense data contains a correct timeout value for retry. When set to zero, the error shall not be reported. When TMOE is zero, the Host may discover a Group 1 timeout only via the Device Busy Event (see).

The default value for TMOE shall be 0. The Host should select TMOE for correct operation based upon its execution environment.

7.9.2.7 DISP

The DISP bit when set to 1 shall make the Drive unavailable until power has been removed and then reapplied. The Drive shall report not ready for all media access after this bit has been set to 1. The default value for DISP shall be 0.

7.9.2.8 SWPP

The SWPP bit provides a Software Write Protect until power has been removed and then reapplied. When this bit is set to 1 the Drive shall prevent writes to the media. When the bit is set to 1, the Drive shall synchronize the write to the media before preventing any further writes. The default value for SWPP shall be 0.

7.9.2.9 Group 1 Minimum Timeout

The Group 1 Minimum Timeout shall be initialized to a value recommended by the Drive. Changing this value is vendor specific. See 4.1.9.2.

7.9.2.10 Group 2 Minimum Timeout

The Group 2 Minimum Timeout shall be initialized to a value recommended by the Drive. Although it is recommended that this value not be changeable, changing this value is vendor specific. See 4.1.9.3.

7.9.2.11 Group 3 Time-out

The Group 3 Time-out shall be initialized to a value recommended by the Drive. Although it is recommended that this value be changeable, changing this value is vendor specific. See .4.1.9.5.

Annex A Implementation Notes: ATA Layer of ATAPI (Informative)

A.1 Introduction

ATAPI is a layered interface. The underlying interface is ATA utilizing a small subset of the ATA command set. The ATA Packetized Interface (ATAPI) provides a mechanism for transferring and executing SCSI CDBs. Since ATA is a single-Host environment, all SCSI commands that are uniquely associated multi-Host situations are neither needed by nor defined for ATAPI devices.

This annex describes the implementation of the packetized layer in the specific case of MM devices. For details on implementing ATAPI on ATA, see [ATA-7].

A.2 Definitions

A.2.1 Host

The SCSI term “Host” is typically replaced by the term “Host” when the underlying interface is not multi-Host. This is the case for ATAPI.

A.2.2 Device

The SCSI term “Device Server” is typically replaced by the term “Device” when the underlying interface does not support multiple physical units. MM devices have exactly one physical Drive.

A.2.3 Command Packet

“Command Packet” is sometimes used in place of “CDB”.

A.2.4 Command Packet Format

The MM ATAPI command packet is fixed at 12 bytes. A 6-byte, 10-byte, or 12-byte SCSI CDB is placed within the ATAPI command packet as shown in Table A.1, Table A.2, and Table A.3. MM ATAPI devices do not support 16-byte SCSI commands.

Within the CDB, the Control byte is reserved and is set to zero.

Table A.1 — ATAPI Command Packet containing a 6-Byte CDB

Bit Byte	7	6	5	4	3	2	1	0
0	Command Operation Code (00h – 1Fh)							
1	Command Parameters							
2								
3								
4								
5	Control Byte = 00h							
6	ATAPI Pad – all zeros							
...								
11								

Table A.2 — ATAPI Command Packet containing a 10-Byte CDB

Bit Byte	7	6	5	4	3	2	1	0
0	Command Operation Code (20h – 5Fh,)							
1	Command Parameters							
2								
3								
4								
5								
6								
7								
8								
9	Control Byte = 00h							
10	ATAPI Pad Byte (00h)							
11	ATAPI Pad Byte (00h)							

Table A.3 — ATAPI Command Packet containing a 12-Byte CDB

Bit Byte	7	6	5	4	3	2	1	0
0	Command Operation Code (A0h – BFh)							
1	Command Parameters							
2								
3								
4								
5								
6								
7								
8								
9								
10								
11	Control Byte = 00h							

A.2.5 Command Status

ATAPI supports only the GOOD and CHECK CONDITION status values.

A.3 No Block Descriptors in MM ATAPI Devices

MM ATAPI devices do not implement Block Descriptors in mode data. The default block size for MM ATAPI devices is 2 048. Other block sizes may be supported.

A.4 Use of Immediate

MM ATAPI devices using the parallel ATAPI do not have the opportunity to use the Disconnect/Reselect mechanism of SCSI. Consequently, the use of immediate operations has a greater importance in MM ATAPI devices. In particular, CD Audio analog play is an immediate operation. Serial ATAPI provides a low level solution to the lack of Disconnect/Reselect.

A.5 Mapping of Reset Functions

Table A.4 shows how the different reset functions specified in the SCSI standards are used in this standard. This table is not intended to show all possible resets or their mapping.

Table A.4 — Example Reset Function Mapping in ATAPI

Reset Type	ATAPI
Power-On Reset	Same as SCSI Power-On Reset
Hard Reset	Hard Reset
Interface Reset	ATA SRST. This is a channel reset and as such is treated as a Hard Reset.
Drive Reset	ATA Drive Reset command

This page is intentionally blank

Annex B Implementation Notes: SCSI Parallel Interface (Informative)

B.1 Introduction

This standard is intended to be used in conjunction with the SCSI Architecture Model [SAM-3], the SCSI Primary Command Set [SPC-3], and the SCSI Parallel Interface [SPI-5].

B.2 SCSI Signal Utilization

The Drive utilizes the same signals and timing as specified in [SPI-5].

B.3 Reset Functionality

B.3.1 Power On Reset

The Power On Reset is an event that causes the Power On condition in SCSI. See SAM-3.

B.3.2 Hard Reset

Hard Reset is described in the SCSI Architecture Model. See "Hard Reset" in SAM-3.

A Hard Reset for a SCSI Device:

- Aborts all tasks in all task sets;
- Clears all auto contingent allegiance conditions;
- Releases all SCSI device reservations;
- Return any device operating modes to their appropriate initial conditions, similar to those conditions that might be found following device power-on. The MODE SELECT conditions are restored to their last saved values if saved values have been established. MODE SELECT conditions for which no saved values, have been established, are returned to their default values;
- Unit Attention condition is set.

B.3.3 TARGET RESET task management function

The TARGET RESET function may be used to reset all Drives in the Target.

Note 33. The TARGET RESET task management function as described in [SPI-5] was called a "Bus Device Reset" in SCSI-2.

If the Initiator issues the DRIVE RESET function to a Drive, the response of the Drive are the same as the response to a TARGET RESET task management function.

B.3.4 Device Reset

There are two possible Device Reset alternatives, ABORT TASK SET and CLEAR TASK SET. The ABORT TASK SET is mandatory for all SCSI Drives. SCSI Drives that do not support tagged tasks may support CLEAR TASK SET.

CLEAR TASK SET is different from ABORT TASK SET in that CLEAR TASK SET clears all of the queued tasks for all Initiators. If the Drive is in a single Initiator environment, ABORT and CLEAR TASK SET functions in the same manner.

The ABORT/CLEAR TASK SET:

- Does not immediately reset SCSI bus protocol.
- Does not reset parameters in mode page to default values
- Always keep the disc information such as disc TOC information
- Does not change the Persistent Prevent state

B.3.5 Power Management and Device Reset in SCSI

When a SCSI Device is in the Power Managed Sleep state, a reset through the service delivery subsystem are used to wake the device.

B.3.6 Mapping of reset functions

Table B.1 shows how the different reset functions specified in the various ATAPI specifications are used in this standard. This table is not intended to show all possible resets or their mapping.

Table B.1 — Example Reset Function Mapping in SCSI

Reset Type	SCSI
Power-On Reset	Same as Power-On Reset
Hard Reset	TARGET RESET task management function
	SAM Reset events – SCSI protocol dependent.
	SPI Reset Signal
Interface Reset	No SCSI equivalent
Device Reset	TARGET RESET

Annex C Implementation Notes: SCSI Serial Bus Protocol (Informative)

C.1 SBP-2 Definitions

C.1.1 Command block

Space reserved within an ORB to describe a command intended for a Drive that controls device functions or the transfer of data to or from device medium.

C.1.2 IEEE 1394

IEEE 1394 is understood as a reference to IEEE Std 1394-1995 as amended by IEEE Std 1394a-2000.

C.1.3 login

The process by which an Initiator obtains access to a set of device fetch agents. The device fetch agents and their control and status registers provide a mechanism for an Initiator to signal ORB's to the device.

C.1.4 quadlet

Four bytes, or 32 bits, of data.

C.1.5 register

A term used to describe quadlet aligned addresses that may be read or written by IEEE 1394 transactions. In the context of this standard, the use of the term register does not imply a specific hardware implementation. e.g., a processor may emulate the behavior of registers.

C.1.6 status block

A data structure written to system memory by a device when an operation request block has been completed.

C.1.7 system memory

The portion of any node's memory that is directly addressable by a IEEE 1394 address and that accepts, at a minimum, quadlet read and write access. Computers are the most common example of nodes that make system memory addressable from IEEE 1394, but any node, including those usually thought of as peripheral devices, may have system memory.

C.1.8 transaction

An exchange between a requester and a responder that consists of a request and a response sub-action is a transaction. The request sub-action transmits a IEEE 1394 transaction such as quadlet read, block write or lock, from the requesting node to the node intended to respond. Some IEEE 1394 commands include data as well as transaction codes. The response sub-action returns completion status and sometimes data from the responding node to the requesting node.

C.1.9 unit

A component of a IEEE 1394 node that provides processing, memory, I/O or some other functionality. Once the node is initialized, the unit provides a CSR interface that is typically accessed by device driver software at an Initiator. A node may have multiple units that normally operate independently of each other. Within this standard, a unit is equivalent to a device.

C.1.10 unit architecture

The specification of the interface to and the services provided by a unit implemented within an IEEE 1394 node.

C.1.11 unit attention

A state that a Drive maintains while it has unsolicited status information to report to one or more logged-in Initiators. A unit attention condition is created as described elsewhere in this standard or in the applicable command set- and device-dependent documents.

C.2 SBP-2 Storage Model

C.2.1 Overview

The SBP-2 Storage Model describes general characteristics and functions of MM Drives when implemented using SBP-2. It is intended to provide design information and lead to a better understanding of MM Drive functionality.

C.2.2 Model configuration

This configuration is used only as an example of a common implementation. The following assumptions are made for this model configuration.

- The device supports a single Drive.
- The device does not support multiple Initiators.
- The device does not support isochronous data transfers.

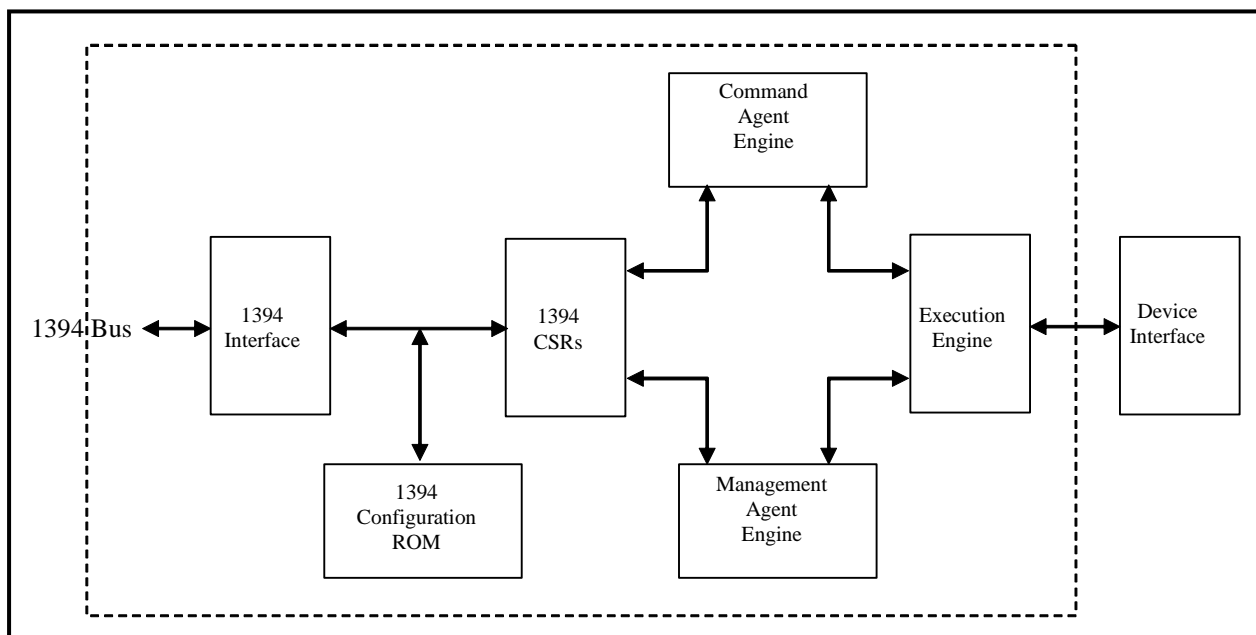

Figure C.1 — Mass storage interface block diagram

C.2.3 Model operation

The block diagram in Figure C.1 indicates the functional blocks contained in an MM device that supports SBP-2. This section describes the function of those blocks when processing a list of ORBs. The ORBs contain READ commands in this example.

After power-on or bus reset, the Command_Agent and Management_Agent engines are in the Reset state.

The Initiator reads the MM device's Configuration ROM data in order to determine its 1394 capabilities, SBP-2 capabilities, EUI-64 value, command set identifiers, software versions, and Management_Agent CSR address.

The Initiator performs a Login operation prior to any request to the MMC2 device. To perform a Login, the Initiator writes its Login ORB address to the Management_Agent register. The Login ORB should contain either the current or master password for the Login to be successful. The MM device returns the Login response to the bus address specified in the Login ORB. One field of the Login response contains the Command_Agent's CSR base address.

Prior to initiating command transfers, the Initiator builds a list of Command_Block ORBs in system memory. The list may be as short as one ORB, but this example assumes a list length of more than one. The last ORB in the list contains a NULL Next_ORB pointer that indicates the end of the list to the MM device's Command_Agent fetch engine.

To transition the Command_Agent state from Reset to Active the Initiator writes the offset of the first ORB in the ORB list to the MM device's ORB_Pointer CSR address. This allows the Command_Agent fetch engine to begin fetching ORBs from Initiator memory. If the Initiator writes to the Doorbell CSR, the MM device ignores the Doorbell at this time.

The MM device fetches ORBs until its ORB space is full or until an ORB containing a NULL Next_ORB pointer is fetched. Fetched ORBs are routed to the Execution engine. The Execution engine may reorder the commands contained in the ORBs for best performance.

As each READ command is processed the MM device transfers READ data to the Initiator's memory space via block write requests.

Following the data transfer portion of each command the MM device writes a Status_Block to the Initiator's Status_FIFO address. The Status_FIFO address for Command Block ORBs is contained in the Login ORB. The status block contains SBP-2 specific command information, such as the ORB_offset of the Command_Block ORB associated with this status, as well as general sense information.

Note 34. ORBs contain a NOTIFY bit that is to be set if a Status_Block is to be written to Initiator memory after every ORB is processed or cleared if a Status_Block is to be written only after ORB execution encounters an error. This bit is advisory only. MM Drives return a Status_Block for all ORBs processed.

If an ORB containing a Null Next_ORB pointer is fetched the Execution engine completes all fetched commands, including the one in the just fetched ORB, before the Command_Agent transitions to the Suspended state.

If additional commands are to be processed, the Initiator creates a new list of Command_Block ORBs; changes the Next_ORB pointer in the last ORB of the old list from NULL to the offset of the first ORB in the new list; then writes to the MM device's Doorbell CSR address. This transitions the Command_Agent to the Active state.

The MM device fetches the new Next_ORB pointer value from the last ORB of the old list and begins fetching ORBS from the new list at that offset.

If the Command_Agent fetch engine has not reached the ORB containing a Null Next_ORB pointer (and is still in the Active state), the MM device ignores any writes to the Doorbell CSR address.

This sequence may continue until the MM device is reset, power is removed, or an error occurs.

C.2.4 Reconnect /Power reset support (normative)

MM Drives support the Reconnect management function following a bus reset, as described in SBP-2. However, in the case that a Reconnect request occurs following a power reset, MM Drives perform as follows:

1. Following a power reset, any previous login information is discarded and the device then transitions to the Reset state.
2. If an Initiator sends a Reconnect ORB to the device, the device returns status with RESP set to 0, REQUEST COMPLETE, and sbp_status set to A₁₆, LOGIN ID NOT RECOGNIZED.

C.3 Configuration ROM support (normative)

C.3.1 Overview

Although most Configuration ROM entries are generic, several contain information that is specific to each device type. Hard disk Drive specific Configuration ROM information is defined in this section.

C.3.2 Unit Directory – Command_Set_Spec_ID

The COMMAND_SET_SPEC_ID entry (key – 38h) is an immediate entry that specifies the organization responsible for the command set definition for the device. SCSI targets have a COMMAND_SET_SPEC_ID of 00 609Eh that indicates that INCITS is responsible for the command set definition.

Bit	7	6	5	4	3	2	1	0
Byte								
0	38h							
1	(MSB)							
2	Command_set_spec_ID = 00 0000h							
3	(LSB)							

C.3.3 Unit Directory – Command_Set

The COMMAND_SET_ENTRY (key – 39h) is an immediate entry that, in combination with the COMMAND_SET_SPEC_ID entry specifies the command set supported by the unit. SCSI targets have a command_set value of 01 04D8h that indicates that the target’s command set is specified by SCSI Primary Commands - 2 [SPC-3] and related command set standard(s), as determined by the targets peripheral device type(s).

Bit	7	6	5	4	3	2	1	0
Byte								
0	39h							
1	(MSB)							
2	Command_set = 00 0001h							
3	(LSB)							

C.3.4 Unit Directory – Command_Set_Revision

The COMMAND_SET_REVISION entry (key – 3Bh) is an immediate entry that specifies the current revision level of the command set implemented by the unit.

Bit	7	6	5	4	3	2	1	0
Byte								
0	3Bh							
1	(MSB)							
2	Command_set_Revision							
3	(LSB)							

C.3.5 Unit Directory – Logical_Unit_Number

The LOGICAL_UNIT_NUMBER entry (key – 14h) is an immediate entry that specifies the device type and the Drive number of a Drive supported by the device. The format of this entry is defined in SBP-2 and duplicated here with additional field information for hard disk drives.

Bit	7	6	5	4	3	2	1	0
Byte								
0	14h							
1	Reserved		Ordered	Device Type = 05h				
2	(MSB) Logical Unit Number							
3	(LSB)							

The Ordered bit (abbreviated as O in the figure above) specifies the manner in which the Drive processes tasks signaled to the command block agent. If the Drive processes and reports completion status without any ordering constraints, the ordered bit is zero. Otherwise, if the Drive both processes all tasks in order and reports their completion status in the same order, the ordered bit is one.

The Device_Type field indicates the peripheral device type implemented by the Drive. The value defined for MM Drives is 05h.

Logical_Unit_Number field identifies the Drive to which the information in the LOGICAL_UNIT_NUMBER entry applies.

C.4 Login support (normative)

MM Drives implement the Login support as defined in SBP-2.

C.5 Security support (normative)

MM Drives implement security against unauthorized media access as defined in the security annex of SBP-2.

The master password, referenced in SBP-2, is contained in the INQUIRY command, Vital Product Data, page 80h. Following a successful Login operation, the Initiator requests that the Drive perform the INQUIRY command, in order to obtain the Drive's serial number.

C.6 Status block support (normative)

The status block for MM Drives is implemented as described in the following text and figure. Refer to SBP-2, Annex B, for a complete description of all bits and fields.

If no exception status is generated, only the first two quadlets (LEN =1) is written to the Initiator's STATUS_FIFO address.

If exception status is generated, the device writes, at a minimum, the four quadlets (len = 2) shown below. This format is required for unsolicited status as well as command status.

Bit	7	6	5	4	3	2	1	0
Byte								
0	src		resp		d	len		
1	Sbp_status							
2	(MSB)							
3								
4	ORB-offset							
5								
6								
7	(LSB)							
8	sfmt			status				
9	v	m	e	i	Sense key			
10	Sense code				Sense code qualifier			
11	(MSB)							
12								
13	Information							
14								
15	(LSB)							

C.7 Unsolicited Status support (normative)

MM Drives that support the SBP-2 transport protocol implements the generation of unsolicited status. Devices notify Initiators of unsolicited status support by setting the ASYNCHRONOUS EVENT REPORTING CAPABILITY (AERC) bit to one in the standard data format of the INQUIRY command (see [SPC-3])

As stated in SBP-2, unsolicited status is enabled when the Initiator writes to the Unsolicited_Status_Enable CSR. Devices default to unsolicited status disabled and only send unsolicited status following a write to the Unsolicited_Status_Enable CSR. The Unsolicited_Status_Enable CSR is a handshake mechanism and is written after every unsolicited status event in order to enable another such event.

C.8 Unit attention condition

A unit attention condition persists for a logged-in Initiator until

- unsolicited status, that reports the unit attention condition, is successfully written to the Initiator's status FIFO address, or
- the Initiator's login becomes invalid or is released. Drives may queue unit attention conditions; more than one unit attention condition may exist at the same time.

Annex D Implementation Notes: Universal Serial Bus (Informative)

D.1 USB and Mass Storage Definitions

D.1.1 Bulk Transfer

This is one of the four USB transfer types. A Bulk transfer:

- a. is non-periodic, large “bursty” communication,
- b. is able to use all undedicated bandwidth,
- c. may be delayed until bandwidth is available.

D.1.2 Capabilities

Those attributes of a USB device that are administrated by the Initiator.

D.1.3 Characteristics

Those qualities of a USB device that are unchangeable between resets; e.g., the device class is a device characteristic.

D.1.4 Command Block Wrapper (CBW)

The CBW is a data structure containing a command block and associated information.

D.1.5 Command Status Wrapper (CSW)

The CSW is a data structure containing the status of a command block.

D.1.6 Control Endpoint

A control endpoint is a pair of device endpoints with the same endpoint number that are used by a control message pipe. Control endpoints transfer data in both directions and, therefore, use both endpoint directions of a device address and endpoint number combination. Thus, each control endpoint consumes two endpoint addresses.

D.1.7 Data-In

Indicates a transfer of data IN from the device to the Initiator.

D.1.8 Data-Out

Indicates a transfer of data OUT from the Initiator to the device.

D.1.9 Default Pipe

The message pipe created by the USB System Software to pass control and status information between the Initiator and a USB device's endpoint zero.

D.1.10 Device

With reference to USB, a device is either a logical or physical entity that performs a function. The actual entity described depends on the context of the reference. At the lowest level, device may refer to a single hardware component, as in a memory device. At a higher level, it may refer to a collection of hardware components that perform a particular function, such as a USB interface device. At an even higher level, device may refer to the function performed by an entity attached to the USB; e.g., a data/FAX modem device. Devices may be physical, electrical, addressable, and logical. When used as a non-specific reference, a USB device is either a hub or a function.

D.1.11 Device Endpoint

The Device Endpoint is a uniquely addressable portion of a USB device that is the source or sink of information in a communication flow between the Initiator and device.

D.1.12 Device Request

Requests from the Initiator to the device using the default pipe.

D.1.13 Endpoint

An endpoint that is capable of consuming an isochronous data stream that is sent by the Initiator.

D.1.14 Endpoint Number

A four-bit value between 0H and FH, inclusive, associated with an endpoint on a USB device.

D.1.15 Message Pipe

A bi-directional pipe that transfers data using a request/data/status paradigm. The data has an imposed structure that allows requests to be reliably identified and communicated.

D.1.16 NAK

This is an abbreviation for negative acknowledgment.

D.1.17 Packet

A bundle of data organized in a group for transmission. Packets typically contain three elements: control information (e.g., source, destination, and length), the data to be transferred, and error detection and correction bits.

D.1.18 Phase

This is a token, data, or handshake packet. A transaction has three phases.

D.1.19 Phase Error

An error returned by the device indicating that the results of processing further CBWs is indeterminate until the device is reset.

D.1.20 Pipe

A pipe is a logical abstraction representing the association between an endpoint on a device and software on the Initiator. A pipe has several attributes; e.g., a pipe may transfer data as streams (stream pipe) or messages (message pipe). See also stream pipe and message pipe. Port Point of access to or from a system or circuit. For the USB, this is the point where a USB device is attached.

D.1.21 Port

A Port is the point of access to or from a system or circuit. For the USB, this is the point where a USB device is attached.

D.1.22 Processed

Data received and controlled internally by the device to the point that the Initiator need no longer be concerned about it.

D.1.23 Protocol

A specific set of rules, procedures, or conventions relating to format and timing of data transmission between two devices.

D.1.24 Relevant

The amount of the data copied in to the Initiator by the device that is significant.

D.1.25 Request

A request made to a USB device contained within the data portion of a SETUP packet.

D.1.26 Reset Recovery

This is an error recovery procedure by which the Initiator prepares the device for further CBWs.

D.1.27 Thin Diagonal

Cases where the Initiator and device are in complete agreement about how many bytes of data to copy in which direction.

D.1.28 Transaction

The delivery of service to an endpoint; consists of a token packet, optional data packet, and optional handshake packet. Specific packets are allowed/required based on the transaction type.

D.1.29 Transfer

One or more bus transactions to move information between a software client and its function.

D.1.30 USB-IF

USB Implementers Forum, Inc. is a nonprofit corporation formed to facilitate the development of USB compliant products and promote the technology. www.usb.org

D.2 Bulk Only Mass Storage

D.2.1 Scope

This normative only covers the Bulk-Only Transport. The complete *USB Mass Storage Class Specification* that covers the Bulk-Only Transport is available at www.usb.org. The CBI (Control/Bulk/Interrupt) transport is used for Full Speed Floppy devices.

D.2.2 Bulk-Only Mass Storage Reset (class-specific request)

This request is used to reset the mass storage device and its associated interface. This class-specific request makes the device ready for the next CBW from the Initiator.

The Initiator sends this request via the default pipe to the device. The device preserves the value of its bulk data toggle bits and endpoint STALL conditions despite the Bulk-Only Mass Storage Reset.

The device NAKs the status stage of the device request until the Bulk-Only Mass Storage Reset is complete.

To issue the Bulk-Only Mass Storage Reset the Initiator issues a device request on the default pipe of:

- bmRequestType: Class, Interface, Initiator to device
- bRequest field set to 255 (FFh)
- wValue field set to 0
- wIndex field set to the interface number
- wLength field set to 0

Table D.1 — Bulk-Only Mass Storage Reset

bmRequestType	bRequest	wValue	wIndex	wLength	Data
00100001b	11111111b	0000h	Interface	0000h	none

D.2.3 Get Max LUN (class-specific request)

The device may implement several Drives that share common device characteristics. The Initiator uses `bCBWLUN` to designate the Drive of the device that is the destination of the CBW. The Get Max LUN device request is used to determine the number of Drives supported by the device. Drive Numbers on the device is numbered contiguously starting from LUN 0 to a maximum LUN of 15 (Fh).

To issue a Get Max LUN device request, the Initiator issues a device request on the default pipe of:

- `bmRequestType`: Class, Interface, device to Initiator
- `bRequest` field set to 254 (Feh)
- `wValue` field set to 0
- `wIndex` field set to the interface number
- `wLength` field set to 1

Table D.2 — Get Max LUN

<code>bmRequestType</code>	<code>bRequest</code>	<code>wValue</code>	<code>wIndex</code>	<code>wLength</code>	Data
10100001b	11111110b	0000h	Interface	0001h	1 byte

The device returns one byte of data that contains the maximum LUN supported by the device. If no LUN is associated with the device, the value returned is 0. The Initiator does not send a command block wrapper (CBW) to a non-existing LUN.

Devices that do not support multiple LUNs may STALL this command.

D.2.4 Initiator/Device Packet Transfer Order

The Initiator sends the CBW before the associated Data-Out, and the device sends Data-In after the associated CBW and before the associated CSW. The Initiator may request Data-In or CSW before sending the associated CBW.

If the `dCBWDataTransferLength` is zero, the device and the Initiator transfers no data between the CBW and the associated CSW.

D.2.5 Command Queuing

The Initiator does not transfer a CBW to the device until the Initiator has received the CSW for any outstanding CBW. If the Initiator issues two consecutive CBWs without an intervening CSW or reset, the device response to the second CBW is indeterminate.

D.2.6 Standard Descriptors

The device supports the following standard USB descriptors:

- a. **Device.** Each USB device has one device descriptor (per *USB Specification*).
- b. **Configuration.** Each USB device has one default configuration descriptor that supports at least one interface.
- c. **Interface.** The device supports at least one interface, known herein as the Bulk-Only Data Interface. Some devices may support additional interfaces, to provide other capabilities.
- d. **Endpoint.** The device supports the following endpoints, in addition to the default pipe that is required of all USB devices:
 1. Bulk-In endpoint
 2. Bulk-Out endpoint
 3. Some devices may support additional endpoints, to provide other capabilities. The Initiator uses the first reported Bulk-In and Bulk-Out endpoints for the selected interface.
- e. **String.** The device supplies a unique serial number.

D.2.7 Device Descriptor

Each USB device has one device descriptor (per *USB Specification*). The device specifies the device class and subclass codes in the interface descriptor, and not in the device descriptor.

Table D.3 — Device Descriptor

Offset	Field	Size	Value	Description
0	bLength	Byte	12h	Size of this descriptor in bytes.
1	bDescriptorType	Byte	01h	DEVICE descriptor type.
2	bcdUSB	Word	xxxxh	<i>USB Specification</i> Release Number in Binary-Coded Decimal (i.e., 2.10 = 210h). This field identifies the release of the <i>USB Specification</i> with which the device and its descriptors are compliant.
4	bDeviceClass	Byte	00h	Class code (assigned by the USB-IF).
5	bDeviceSubClass	Byte	00h	Subclass code (assigned by the USB-IF).
6	bDeviceProtocol	Byte	00h	Protocol code (assigned by the USB-IF).
7	bMaxPacketSize0	Byte	xxh	Maximum packet size for endpoint zero. (only 8, 16, 32, or 64 are valid (08h, 10h, 20h, 40h)).
8	idVendor	Word	xxxxh	Vendor ID (assigned by the USB-IF).
10	idProduct	Word	xxxxh	Product ID (assigned by the manufacturer).
12	bcdDevice	Word	xxxxh	Device release number in binary-coded decimal.
14	iManufacturer	Byte	xxh	Index of string descriptor describing the manufacturer.
15	iProduct	Byte	xxh	Index of string descriptor describing this product.
16	iSerialNumber	Byte	xxh	Index of string descriptor describing the device's serial number.
17	bNumConfigurations	Byte	xxh	Number of possible configurations.

D.2.8 Serial Number

The iSerialNumber field is set to the index of the string descriptor that contains the serial number. The serial number contains at least 12 valid digits, represented as a UNICODE string. The last 12 digits of the serial number is unique to each USB idVendor and idProduct pair.

The Initiator may generate a globally unique identifier by concatenating the 16-bit idVendor, the 16 bit idProduct and the value represented by the last 12 characters of the string descriptor indexed by iSerialNumber.

The field iSerialNumber is an index to a string descriptor and does not contain the string itself.

D.2.9 Valid Serial Number Characters

Numeric numbers 0030h through 0039h that represent ASCII "0" through "9" and 0041h through 0046h as ASCII "A" through "F".

D.3 Descriptors

D.3.1 Configuration Descriptor

Table D.4 — Configuration Descriptor

Offset	Field	Size	Value	Description										
0	bLength	Byte	09h	Size of this descriptor in bytes.										
1	bDescriptorType	Byte	02h	CONFIGURATION Descriptor Type.										
2	wTotalLength	Word	xxxxh	Total length of data returned for this configuration. Includes the combined length of all descriptors (configuration, interface, endpoint, and class- or vendor-specific) returned for this configuration.										
4	bNumInterfaces	Byte	xxh	Number of interfaces supported by this configuration. The device supports at least the Bulk-Only Data Interface.										
5	bConfigurationValue	Byte	xxh	Value to use as an argument to the SetConfiguration() request to select this configuration.										
6	iConfiguration	Byte	xxh	Index of string descriptor describing this configuration.										
7	bmAttributes	Byte	x0h	Configuration characteristics: <table border="0" style="margin-left: 20px;"> <tr> <td style="text-align: right;"><u>Bit</u></td> <td style="text-align: left;"><u>Description</u></td> </tr> <tr> <td style="text-align: right;">7</td> <td>Reserved (set to one)</td> </tr> <tr> <td style="text-align: right;">6</td> <td>Self-powered</td> </tr> <tr> <td style="text-align: right;">5</td> <td>Remote Wakeup</td> </tr> <tr> <td style="text-align: right;">4..0</td> <td>Reserved (reset to zero)</td> </tr> </table> Bit 7 is reserved and is set to one for historical reasons.	<u>Bit</u>	<u>Description</u>	7	Reserved (set to one)	6	Self-powered	5	Remote Wakeup	4..0	Reserved (reset to zero)
<u>Bit</u>	<u>Description</u>													
7	Reserved (set to one)													
6	Self-powered													
5	Remote Wakeup													
4..0	Reserved (reset to zero)													
8	MaxPower	Byte	xxh	Maximum power consumption of the USB device from the bus in this specific configuration when the device is fully operational. Expressed in 2mA units (i.e., 50 = 100mA)										

D.3.2 Interface Descriptor

The device supports at least one interface, known herein as the Bulk-Only Data Interface. The Bulk-Only Data Interface uses three endpoints.

Composite mass storage devices may support additional interfaces, to provide other features such as audio or video capabilities. This specification does not define such interfaces.

The interface may have multiple alternate settings. The Initiator examines each of the alternate settings to look for the bInterfaceProtocol and bInterfaceSubClass it supports optimally.

Table D.5 — Bulk-Only Data Interface Descriptor

Offset	Field	Size	Value	Description
0	bLength	Byte	09h	Size of this descriptor in bytes.
1	bDescriptorType	Byte	04h	INTERFACE Descriptor Type.
2	bInterfaceNumber	Byte	0xh	Number of interface. Zero-based value identifying the index in the array of concurrent interfaces supported by this configuration.
3	bAlternateSetting	Byte	xxh	Value used to select alternate setting for the interface identified in the prior field.
4	bNumEndpoints	Byte	xxh	Number of endpoints used by this interface (excluding endpoint zero). This value is at least 2.
5	bInterfaceClass	Byte	08h	MASS STORAGE Class.
6	bInterfaceSubClass	Byte	0xh	Subclass code (assigned by the USB-IF). Indicates the industry standard command block definition to use. Does not specify a type of storage device such as a floppy disk or CD-ROM drive.
7	bInterfaceProtocol	Byte	50h	BULK-ONLY TRANSPORT.
8	iInterface	Byte	xxh	Index to string descriptor describing this interface.

D.3.3 Endpoint Descriptors

The device supports at least three endpoints: Control, Bulk-In and Bulk-Out.

Each USB device defines a Control endpoint (Endpoint 0). This is the default endpoint and does not require a descriptor.

D.3.4 Bulk-In Endpoint

The Bulk-In endpoint is used for transferring data and status from the device to the Initiator.

Table D.6 — Bulk-In Endpoint Descriptor

Offset	Field	Size	Value	Description								
0	bLength	Byte	07h	Size of this descriptor in bytes.								
1	bDescriptorType	Byte	05h	ENDPOINT Descriptor Type.								
2	bEndpointAddress	Byte	xxh	The address of this endpoint on the USB device. The address is encoded as follows. <table border="1" style="margin-left: 40px;"> <thead> <tr> <th>Bit</th> <th>Description</th> </tr> </thead> <tbody> <tr> <td>3..0</td> <td>The endpoint number</td> </tr> <tr> <td>6..4</td> <td>Reserved, set to 0</td> </tr> <tr> <td>7</td> <td>1 = In</td> </tr> </tbody> </table>	Bit	Description	3..0	The endpoint number	6..4	Reserved, set to 0	7	1 = In
Bit	Description											
3..0	The endpoint number											
6..4	Reserved, set to 0											
7	1 = In											
3	bmAttributes	Byte	02h	This is a Bulk endpoint.								
4	wMaxPacketSize	Word	00xxh	Maximum packet size. Is 8, 16, 32 or 64 decimal bytes.								
6	bInterval	Byte	00h	Does not apply to Bulk endpoints.								

D.3.5 Bulk-Out Endpoint

The Bulk-Out endpoint is used for transferring command and data from the Initiator to the device.

Table D.7 — Bulk-Out Endpoint Descriptor

Offset	Field	Size	Value	Description								
0	bLength	Byte	07h	Size of this descriptor in bytes.								
1	bDescriptorType	Byte	05h	ENDPOINT descriptor type.								
2	bEndpointAddress	Byte	0xh	The address of this endpoint on the USB device. This address is encoded as follows: <table border="0" style="margin-left: 40px;"> <tr> <td style="text-align: right;"><u>Bit</u></td> <td style="text-align: left;"><u>Description</u></td> </tr> <tr> <td style="text-align: right;">3..0</td> <td>Endpoint number</td> </tr> <tr> <td style="text-align: right;">6..4</td> <td>Reserved, set to 0</td> </tr> <tr> <td style="text-align: right;">7</td> <td>0 = Out</td> </tr> </table>	<u>Bit</u>	<u>Description</u>	3..0	Endpoint number	6..4	Reserved, set to 0	7	0 = Out
<u>Bit</u>	<u>Description</u>											
3..0	Endpoint number											
6..4	Reserved, set to 0											
7	0 = Out											
3	bmAttributes	Byte	02h	This is a Bulk endpoint.								
4	wMaxPacketSize	Word	00xxh	Maximum packet size. Is 8, 16, 32 or 64 decimal bytes.								
6	bInterval	Byte	00h	Does not apply to Bulk endpoints.								

D.4 Command/Data/Status Protocol

D.4.1 Command Block Wrapper (CBW)

The CBW starts on a packet boundary and ends as a short packet with exactly 31 (1Fh) bytes transferred. Fields appear aligned to byte offsets equal to a multiple of their byte size. All subsequent data and the CSW start at a new packet boundary. All CBW transfers are ordered with the LSB (byte 0) first (little endian).

Table D.8 — Command Block Wrapper

Bit	7	6	5	4	3	2	1	0
0	(LS Byte) dCBWSignature (MS Byte)							
...								
3								
4	(LS Byte) dCBWTag (MS Byte)							
...								
7								
8	(LS Byte) dCBWDataTransferLength (MS Byte)							
...								
11								
12	bmCBWFlags							
	Direction	Obsolete						Reserved
13	Reserved				bCBWLUN			
14	Reserved			bCBWCBLength				
15	CBWCB							
...								
30								

The dCBWSignature field helps identify this data packet as a CBW. The signature field contains the value 43425355h (little endian), indicating a CBW.

The dCBWTag field is a Command Block Tag sent by the Initiator. The device echos the contents of this field back to the Initiator in the dCSWTag field of the associated CSW. The dCSWTag positively associates a CSW with the corresponding CBW.

The dCBWDataTransferLength field is the number of bytes of data that the Initiator expects to transfer on the Bulk-In or Bulk-Out endpoint (as indicated by the Direction bit) during the execution of this command. If this field is zero, the device and the Initiator transfers no data between the CBW and the associated CSW, and the device ignores the value of the Direction bit in bmCBWFlags.

The bmCBWFlags field is bit significant:

Direction - the device ignores this bit if the dCBWDataTransferLength field is zero, otherwise:

0 = Data-Out from Initiator to the device,

1 = Data-In from the device to the Initiator.

The bCBWLUN field contains the device Drive Number (LUN) to which the command block is being sent. For devices that support multiple LUNs, the Initiator places into this field the LUN to which this command block is addressed. Otherwise, the Initiator sets this field to zero.

The bCBWCBLength field contains the valid length of the CBWCB field in bytes. The only legal values are 1 through 16 (01h through 10h). All other values are reserved.

The CBWCB field is the command block to be processed by the device. The device interprets the first bCBWCBLength bytes in this field as a command block as defined by the command set identified by bInterfaceSubClass. If the command set supported by the device uses command blocks of fewer than 16 (10h) bytes in length, the significant bytes are transferred first, beginning with the byte at offset 15 (Fh). The device ignores the content of the CBWCB field past the byte at offset (15 + bCBWCBLength – 1).

D.4.2 Command Status Wrapper (CSW)

The CSW starts on a packet boundary and ends as a short packet with exactly 13 (0Dh) bytes transferred.

Fields appear aligned to byte offsets equal to a multiple of their byte size. All CSW transfers are ordered with the LSB (byte 0) first (little endian).

Table D.9 — Command Status Wrapper

Bit	7	6	5	4	3	2	1	0
0	(LS Byte) dCSWSignature (MS Byte)							
...								
3								
4	(LS Byte) dCSWTag (MS Byte)							
...								
7								
8	(LS Byte) dCSWDataResidue (MS Byte)							
...								
11								
12	bmCSWStatus							

The dCSWSignature field contains the value 53425355h (little endian), indicating CSW.

The dCSWTag is set to the value received in the dCBWTag of the associated CBW.

The dCSWDataResidue field definition is dependent upon the data direction of the associated CBW. For Data-Out the dCSWDataResidue contains the difference between the amount of data expected as stated in the dCBWDataTransferLength, and the actual amount of data processed by the device. For Data-In the dCSWDataResidue contains the difference between the amount of data expected as stated in the

dCBWDataTransferLength and the actual amount of relevant data sent by the device. The dCSWDataResidue does not exceed the value sent in the dCBWDataTransferLength.

The bCSWStatus field contains the ending status of the command. The device sets this byte to zero if the command completed successfully. A non-zero value indicates a failure during Command Processing according to the following table:

Table D.10 — Command Block Status Values

Value	Description
00h	Command Passed ("good status")
01h	Command Failed
02h	Phase Error
03h and 04h	Reserved
05h to FFh	Reserved

Annex E Legacy Specifications (Normative)

E.1 Overview

There are features, profiles, commands, command options, mode pages, and fields within structures defined in earlier standards that are not recommended for use in multi-media devices. Due to the prevalence of installed systems that require continued use of these capabilities, the formal path of obsolescence may have undesirable results. This annex provides references for the correct implementation of each legacy method.

If a legacy method is implemented, the implementation should be according to the description found in the reference.

E.2 CD Audio External Play

All MMC support for CD Audio External Play has been removed from MMC-5. Consult MMC-4 for the most recent information on:

- 1) Terms and definitions for CD Audio External Play,
- 2) Modeling that describes CD Audio External Play,
- 3) CD Audio External Play Feature (0103h)
- 4) PAUSE/RESUME Command
- 5) PLAY AUDIO (10) Command
- 6) PLAY AUDIO (12) Command
- 7) PLAY AUDIO MSF Command
- 8) READ SUB-CHANNEL Command
- 9) STOP PLAY/SCAN Command
- 10) CD Audio Control Page (Page Code 0Eh)

E.3 Double Density Compact Disc (DDCD)

All MMC support for Double Density Compact Disc (DDCD) has been removed from MMC-5. Consult MMC-4 for the most recent information on:

- 1) Terms and definitions for DDCCD-ROM, DDCCD-R, and DDCCD-RW,
- 2) Modeling that describes DDCCD-ROM, DDCCD-R, and DDCCD-RW,
- 3) The DDCCD-ROM Profile (0020h) definition,
- 4) The DDCCD-R Profile (0021h) definition,
- 5) The DDCCD-RW Profile (0022h) definition,
- 6) The DDCCD-ROM Read Feature (0030h) definition,
- 7) The DDCCD-R Write Feature (0031h) definition,
- 8) The DDCCD-RW Write Feature (0032h) definition,
- 9) All command descriptions for DDCCD,
- 10) All mode page descriptions for DDCCD.

E.4 GET EVENT STATUS NOTIFICATION Command – Operational Change Events

When the Notification Class code in the Event Header is 001b, an Operational Change Event Descriptor follows the event header. In MMC-4 and in MMC-5 the descriptions of the behavior and status values are different than those found in MMC-3.

Refer to MMC-3 for legacy descriptions.

E.5 GET EVENT STATUS NOTIFICATION Command – Device Busy Events

Device Busy Events are used to notify the Initiator of commands that are executing but that require an abnormally long time to complete. In MMC-4 and in MMC-5 the descriptions of the behavior and status values are different than those found in MMC-3.

Refer to MMC-3 for legacy descriptions.

E.6 FORMAT UNIT Command, Format Code = 111b

The description for CDB Format Code 111b is a method defined only for CD-RW. Refer to MMC-3 for the most recent descriptions.

E.7 SEND EVENT Command

The SEND EVENT command requests the Drive to process an event on behalf of the Initiator. The most recent description of this command is found in MMC-3.

E.8 Mode Parameters Block Descriptors

Block Descriptors should not be used in MMC devices. Some legacy devices may support block descriptors. The general description of of block descriptors and their use is described in [SPC-3].

The block descriptor associated with the MODE SELECT and MODE SENSE commands allows block size specification for CD sectors. If a block descriptor is supported, then at least a block size of 2 048 should be supported. Other block sizes may be supported. Table E.11 shows the possibilities for the various block sizes. These block size definitions apply for READ (6), READ (10), READ (12), VERIFY (10) and VERIFY (12) commands.

Valid block sizes are shown in Table E.11.

Table E.11 — Block Descriptor Block Sizes for Read

Bytes	Readable block types
512	Mode 1 or Mode 2 Form 1 sectors divided into four blocks each
2 048	Mode 1, Mode 2 Form1, (and DVD)
2056	Mode 2 Form 1 with sub-header. Equivalent to READ CD, Flag = 50h.
2 324	Mode 2 Form 2 with no sub-header. There is no mapping to READ CD, as the 4 spare bytes are not returned.
2 332	Mode 2, Form 1 or 2 data. The Drive should operate as specified for 2 048 byte blocks except that both forms send 2 332 byte blocks. Form 1 blocks return the third layer ECC with the user data. There is no mapping to READ CD, as the 4 spare bytes are not returned.
2 336	Mode 2 data. The Drive should operate as specified for 2 048 byte block lengths. This mode includes all data: Yellow Book Mode 2 sectors and Form 1 & 3. This is equivalent to READ CD, Flag = 58h.
2 340	All bytes except the synchronization field. Equivalent to READ CD, Flag = 78h.
2 352	Audio or raw blocks. The Drive should operate as specified for 2 048 byte block lengths. A read of data mode sectors should return de-scrambled data. Equivalent to READ CD, Flag = F8h.
2 448 or 2 368	Audio or raw blocks with raw Sub-channel. The Drive should not perform the data descrambling operation. Equivalent to READ CD, Flag = F8. Sub-channel data selection = 010b (2 448) or Sub-channel data selection = 001b (2 368).

E.9 READ TOC/PMA/ATIP Command: CDB Format field definition

A unique version of the READ TOC/PMA/ATIP command is described in SFF8020, version 1.2. This document was withdrawn by SFF and is no longer available from that organization.

The Format field for the READ TOC/PMA/ATIP command is a 4-bit field occupying bits 3 through 0 of byte 2 as shown in Table E.1. The SFF8020, version 1.2 defines the READ TOC/PMA/ATIP command differently. The Format field is a 2-bit field that occupies bits 6 and 7 of byte 9 (see Table E.1). This field should be examined only when the MMC Format Field is set to 0000b.

Table E.1 — READ TOC/PMA/ATIP CDB - Legacy Version

Bit	7	6	5	4	3	2	1	0	
Byte									
0	Operation Code (43h)								
1	Reserved						MSF	Reserved	
2	Reserved				MMC Format				
3	Reserved								
4	Reserved								
5	Reserved								
6	Starting Track/Session Number								
7	(MSB) Allocation Length								
8	(LSB)								
9	SFF8020 Format			Control					

The value of the Format field (Table E.2) defines the returned data format.

Table E.2 — Format Field Values

SFF8020 Format	MSF	Track/Session Number	Description
00b	Valid	Track Number	The Track/Session Number field specifies starting track number for which the data is returned. For multi-session discs, TOC data is returned for all sessions. Track number AAh is reported only for the Lead-out area of the last complete session.
01b	Valid	Reserved ¹	This format returns the first complete session number, last complete session number and last complete session starting address. In this format, the Track/Session Number field is reserved and should be set to 00h.
10b	Reserved ¹	Session Number	This format returns all Q sub-code data in the Lead-In (TOC) areas starting from a session number as specified in the Track/Session Number field. In this mode, the Drive should support Q Sub-channel POINT field value of A0h, A1h, A2h, Track numbers, B0h, B1h, B2h, B3h, B4h, C0h, and C1h. There is no defined LBA addressing and MSF bit should be set to one.
11b	Reserved		

¹The Drive should ignore the field. No error should be posted.

A PC BIOS may require this CDB format for the CD boot process. It is recommended that Drives that support CD boot, should support both the older and newer CDB formats.

E.10 CD Device Parameters Mode Page (Page 0Dh)

The CD Parameters page is a legacy mode page. The CD Parameters page specifies parameters that affect only CD-ROM Drives. The CD Parameters page was most recently defined in MMC-3.

E.11 MM Capabilities and Mechanical Status Page (Page Code 2Ah)

The MM Capabilities and Mechanical Status Page is read only. This mode page is legacy and was most recently defined in MMC-3.

Annex F Error Reporting (Normative)

F.1 Overview

This annex lists error codes that may be generated by MMC defined Drives. Specific commands specify that certain errors occur in response to certain conditions, but each command does not contain a comprehensive list of possible error conditions.

F.2 Deferred Errors

Any error may be reported in response to any command due to the occurrence of a deferred error. e.g., a write error may occur due to a cached write command and that error should be reported in response to the next command.

F.3 Error Lists

A number of tables are included within this annex for error classification. Each table has columns identifying SK, ASC, and ASCQ values and the associated meaning. Each command description sub-clause contains an error-reporting table with entries that reference the tables included within this annex. The ASC and ASCQ values in this subclause duplicate information found in [SPC-3]. In the event there is a conflict between the ASC/ASCQ values in this standard and the ASC/ASCQ values in [SPC-3], the values in this standard shall prevail.

There are 9 classifications:

1. Unit Attention conditions,
2. CDB or parameter list validation,
3. Readiness errors,
4. Protocol errors,
5. General media access errors,
6. Errors associated with reading,
7. Errors associated with writing,
8. Hardware failures, and
9. Errors associated with non-ATAPI environments.

F.3.1 Unit Attention conditions

Unit Attention conditions exist to report status information to the Host. Table F.1 shows typical Unit Attention conditions for multi-media devices.

Table F.1 — Unit Attention Conditions

SK	ASC	ASCQ	Description
6	28	00	NOT READY TO READY CHANGE, MEDIUM MAY HAVE CHANGED
6	28	01	IMPORT OR EXPORT ELEMENT ACCESSED
6	29	00	POWER ON, RESET, OR BUS DEVICE RESET OCCURRED
6	29	01	POWER ON OCCURRED
6	29	02	BUS RESET OCCURRED
6	29	03	BUS DEVICE RESET FUNCTION OCCURRED
6	29	04	DEVICE INTERNAL RESET
6	2A	00	PARAMETERS CHANGED
6	2A	01	MODE PARAMETERS CHANGED
6	2A	02	LOG PARAMETERS CHANGED
6	2E	00	INSUFFICIENT TIME FOR OPERATION
6	3B	0D	MEDIUM DESTINATION ELEMENT FULL
6	3B	0E	MEDIUM SOURCE ELEMENT EMPTY
6	3B	0F	END OF MEDIUM REACHED
6	3B	11	MEDIUM MAGAZINE NOT ACCESSIBLE
6	3B	12	MEDIUM MAGAZINE REMOVED
6	3B	13	MEDIUM MAGAZINE INSERTED
6	3B	14	MEDIUM MAGAZINE LOCKED
6	3B	15	MEDIUM MAGAZINE UNLOCKED
6	3F	00	TARGET OPERATING CONDITIONS HAVE CHANGED
6	3F	01	MICROCODE HAS BEEN CHANGED
6	3F	02	CHANGED OPERATING DEFINITION
6	3F	03	INQUIRY DATA HAS CHANGED
6	5A	00	OPERATOR REQUEST OR STATE CHANGE INPUT
6	5A	01	OPERATOR MEDIUM REMOVAL REQUEST
6	5A	02	OPERATOR SELECTED WRITE PROTECT
6	5A	03	OPERATOR SELECTED WRITE PERMIT
6	5B	00	LOG EXCEPTION
6	5B	01	THRESHOLD CONDITION MET
6	5B	02	LOG COUNTER AT MAXIMUM

Table F.1 — Unit Attention Conditions (Continued)

SK	ASC	ASCQ	Description
6	5B	03	LOG LIST CODES EXHAUSTED
6	5E	00	LOW POWER CONDITION ON
6	5E	01	IDLE CONDITION ACTIVATED BY TIMER
6	5E	02	STANDBY CONDITION ACTIVATED BY TIMER
6	5E	03	IDLE CONDITION ACTIVATED BY COMMAND
6	5E	04	STANDBY CONDITION ACTIVATED BY COMMAND

F.3.2 CDB or Parameter Validation Errors

When a CDB field or parameter list field is not valid and rounding is not possible, the command is terminated with CHECK CONDITION status and sense bytes SK/ASC/ASCQ should be selected from those shown in Table F.2.

Table F.2 — CDB or Parameter Validation Errors

SK	ASC	ASCQ	Description
5	1A	00	PARAMETER LIST LENGTH ERROR
5	20	00	INVALID COMMAND OPERATION CODE
5	21	00	LOGICAL BLOCK ADDRESS OUT OF RANGE
5	21	01	INVALID ELEMENT ADDRESS
5	21	02	INVALID ADDRESS FOR WRITE
5	24	00	INVALID FIELD IN CDB
5	26	00	INVALID FIELD IN PARAMETER LIST
5	26	01	PARAMETER NOT SUPPORTED
5	26	02	PARAMETER VALUE INVALID
5	26	03	THRESHOLD PARAMETERS NOT SUPPORTED

F.3.3 Readiness Errors

In the event that a command requires a level of readiness that does not currently exist, the Drive should be terminated with CHECK CONDITION status and sense bytes SK/ASC/ASCQ should be selected from those shown in Table F.3.

Table F.3 — Readiness Errors

SK	ASC	ASCQ	Description
2	04	00	LOGICAL UNIT NOT READY, CAUSE NOT REPORTABLE
2	04	01	LOGICAL UNIT IS IN PROCESS OF BECOMING READY
2	04	02	LOGICAL UNIT NOT READY, INITIALIZING CMD. REQUIRED
2	04	03	LOGICAL UNIT NOT READY, MANUAL INTERVENTION REQUIRED
2	04	04	LOGICAL UNIT NOT READY, FORMAT IN PROGRESS
2	04	07	LOGICAL UNIT NOT READY, OPERATION IN PROGRESS
2	04	08	LOGICAL UNIT NOT READY, LONG WRITE IN PROGRESS
2	04	09	WRITE ERROR RECOVERY NEEDED
2	30	00	INCOMPATIBLE MEDIUM INSTALLED
2	30	01	CANNOT READ MEDIUM – UNKNOWN FORMAT
2	30	02	CANNOT READ MEDIUM – INCOMPATIBLE FORMAT
2	30	03	CLEANING CARTRIDGE INSTALLED
2	30	04	CANNOT WRITE MEDIUM – UNKNOWN FORMAT
2	30	05	CANNOT WRITE MEDIUM – INCOMPATIBLE FORMAT
2	30	06	CANNOT FORMAT MEDIUM – INCOMPATIBLE MEDIUM
2	30	07	CLEANING FAILURE
2	30	11	CANNOT WRITE MEDIUM – UNSUPPORTED MEDIUM VERSION
2	3A	00	MEDIUM NOT PRESENT
2	3A	01	MEDIUM NOT PRESENT – TRAY CLOSED
2	3A	02	MEDIUM NOT PRESENT – TRAY OPEN
2	3E	00	LOGICAL UNIT HAS NOT SELF-CONFIGURED YET

F.3.4 Protocol Errors

Table F.4 — Protocol Errors

SK	ASC	ASCQ	Description
5	2C	00	COMMAND SEQUENCE ERROR
5	2C	03	CURRENT PROGRAM AREA IS NOT EMPTY
5	2C	04	CURRENT PROGRAM AREA IS EMPTY
5	30	08	CANNOT WRITE — APPLICATION CODE MISMATCH
5	30	09	CURRENT SESSION NOT FIXATED FOR APPEND
5	30	10	MEDIUM NOT FORMATTED
5	39	00	SAVING PARAMETERS NOT SUPPORTED
5	3D	00	INVALID BITS IN IDENTIFY MESSAGE
5	43	00	MESSAGE ERROR
5	53	02	MEDIUM REMOVAL PREVENTED
5	64	00	ILLEGAL MODE FOR THIS TRACK
5	64	01	INVALID PACKET SIZE
5	6F	00	COPY PROTECTION KEY EXCHANGE FAILURE – AUTHENTICATION FAILURE
5	6F	01	COPY PROTECTION KEY EXCHANGE FAILURE – KEY NOT PRESENT
5	6F	02	COPY PROTECTION KEY EXCHANGE FAILURE –KEY NOT ESTABLISHED
5	6F	03	READ OF SCRAMBLED SECTOR WITHOUT AUTHENTICATION
5	6F	04	MEDIA REGION CODE IS MISMATCHED TO LOGICAL UNIT REGION
5	6F	05	LOGICAL UNIT REGION MUST BE PERMANENT/REGION RESET COUNT ERROR
5	72	04	EMPTY OR PARTIALLY WRITTEN RESERVED TRACK
5	72	05	NO MORE TRACK RESERVATIONS ALLOWED

F.3.5 General Media Access Errors

Table F.5 — General Media Access Errors

SK	ASC	ASCQ	Description
3	06	00	NO REFERENCE POSITION FOUND
4	09	00	TRACK FOLLOWING ERROR
4	09	01	TRACKING SERVO FAILURE
4	09	02	FOCUS SERVO FAILURE
4	09	03	SPINDLE SERVO FAILURE
3	15	00	RANDOM POSITIONING ERROR
3	15	01	MECHANICAL POSITIONING ERROR
5	30	00	INCOMPATIBLE MEDIUM INSTALLED
5	30	01	CANNOT READ MEDIUM – UNKNOWN FORMAT
5	30	02	CANNOT READ MEDIUM – INCOMPATIBLE FORMAT
5	30	03	CLEANING CARTRIDGE INSTALLED
5	30	04	CANNOT WRITE MEDIUM – UNKNOWN FORMAT
5	30	05	CANNOT WRITE MEDIUM – INCOMPATIBLE FORMAT
5	30	06	CANNOT FORMAT MEDIUM – INCOMPATIBLE MEDIUM
5	30	07	CLEANING FAILURE
5	30	08	CANNOT WRITE – APPLICATION CODE MISMATCH
5	30	09	CURRENT SESSION NOT FIXATED FOR APPEND
5	30	10	MEDIUM NOT FORMATTED
3	31	00	MEDIUM FORMAT CORRUPTED
3	31	01	FORMAT COMMAND FAILED
3	31	02	ZONED FORMATTING FAILED DUE TO SPARE LINKING
3	57	00	UNABLE TO RECOVER TABLE-OF-CONTENTS
3	73	00	CD CONTROL ERROR

F.3.6 Errors Associated with Reading

Table F.6 — Errors Associated with Reading

SK	ASC	ASCQ	Description
3	11	00	UNRECOVERED READ ERROR
3	11	01	READ RETRIES EXHAUSTED
3	11	02	ERROR TOO LONG TO CORRECT
3	11	05	L-EC UNCORRECTABLE ERROR
3	11	06	CIRC UNRECOVERED ERROR
3	11	0F	ERROR READING UPC/EAN NUMBER
3	11	10	ERROR READING ISRC NUMBER
B	11	11	READ ERROR – LOSS OF STREAMING
3	15	00	RANDOM POSITIONING ERROR
3	15	01	MECHANICAL POSITIONING ERROR
3	15	02	POSITIONING ERROR DETECTED BY READ OF MEDIUM
1	17	00	RECOVERED DATA WITH NO ERROR CORRECTION APPLIED
1	17	01	RECOVERED DATA WITH RETRIES
1	17	02	RECOVERED DATA WITH POSITIVE HEAD OFFSET
1	17	03	RECOVERED DATA WITH NEGATIVE HEAD OFFSET
1	17	04	RECOVERED DATA WITH RETRIES AND/OR CIRC APPLIED
1	17	05	RECOVERED DATA USING PREVIOUS SECTOR ID
1	17	07	RECOVERED DATA WITHOUT ECC – RECOMMEND REASSIGNMENT
1	17	08	RECOVERED DATA WITHOUT ECC – RECOMMEND REWRITE
1	17	09	RECOVERED DATA WITHOUT ECC – DATA REWRITTEN
1	18	00	RECOVERED DATA WITH ERROR CORRECTION APPLIED
1	18	01	RECOVERED DATA WITH ERROR CORR. & RETRIES APPLIED
1	18	02	RECOVERED DATA – DATA AUTO-REALLOCATED
1	18	03	RECOVERED DATA WITH CIRC
1	18	04	RECOVERED DATA WITH L-EC
1	18	05	RECOVERED DATA – RECOMMEND REASSIGNMENT
1	18	06	RECOVERED DATA – RECOMMEND REWRITE
1	18	08	RECOVERED DATA WITH LINKING
8	--	--	BLANK CHECK

F.3.7 Errors Associated with Writing

Table F.7 — Errors Associated with Writing

SK	ASC	ASCQ	Description
3	0C	00	WRITE ERROR
3	0C	07	WRITE ERROR – RECOVERY NEEDED
3	0C	08	WRITE ERROR – RECOVERY FAILED
3	0C	09	WRITE ERROR – LOSS OF STREAMING
3	0C	0A	WRITE ERROR – PADDING BLOCKS ADDED
7	27	00	WRITE PROTECTED
7	27	01	HARDWARE WRITE PROTECTED
7	27	02	LOGICAL UNIT SOFTWARE WRITE PROTECTED
7	27	03	ASSOCIATED WRITE PROTECT
7	27	04	PERSISTENT WRITE PROTECT
7	27	05	PERMANENT WRITE PROTECT
7	27	06	CONDITIONAL WRITE PROTECT
2	30	04	CANNOT WRITE MEDIUM – UNKNOWN FORMAT
2	30	05	CANNOT WRITE MEDIUM – INCOMPATIBLE FORMAT
2	30	06	CANNOT FORMAT MEDIUM – INCOMPATIBLE MEDIUM
2	30	07	CLEANING FAILURE
5	30	08	CANNOT WRITE – APPLICATION CODE MISMATCH
5	30	09	CURRENT SESSION NOT FIXATED FOR APPEND
5	30	10	MEDIUM NOT FORMATTED
2	30	11	CANNOT WRITE MEDIUM – UNSUPPORTED MEDIUM VERSION
3	31	00	MEDIUM FORMAT CORRUPTED
3	31	01	FORMAT COMMAND FAILED
3	31	02	ZONED FORMATTING FAILED DUE TO SPARE LINKING
3	51	00	ERASE FAILURE
3	51	01	ERASE FAILURE – INCOMPLETE ERASE OPERATION DETECTED
1	5D	03	FAILURE PREDICTION THRESHOLD EXCEEDED – Predicted Spare Area Exhaustion
1	5D	FF	FAILURE PREDICTION THRESHOLD EXCEEDED (FALSE)
3	72	00	SESSION FIXATION ERROR
3	72	01	SESSION FIXATION ERROR WRITING LEAD-IN
3	72	02	SESSION FIXATION ERROR WRITING LEAD-OUT
5	72	03	SESSION FIXATION ERROR – INCOMPLETE TRACK IN SESSION

Table F.7 — Errors Associated with Writing (Continued)

SK	ASC	ASCQ	Description
5	72	04	EMPTY OR PARTIALLY WRITTEN RESERVED TRACK
5	72	05	NO MORE TRACK RESERVATIONS ALLOWED
1	73	01	POWER CALIBRATION AREA ALMOST FULL
3	73	02	POWER CALIBRATION AREA IS FULL
3	73	03	POWER CALIBRATION AREA ERROR
3	73	04	PROGRAM MEMORY AREA UPDATE FAILURE
3	73	05	PROGRAM MEMORY AREA IS FULL
1	73	06	RMA/PMA IS ALMOST FULL
8	--	--	BLANK CHECK

F.3.8 Hardware Failures

Table F.8 — Hardware Failures

SK	ASC	ASCQ	Description
4	00	17	CLEANING REQUESTED
4	05	00	LOGICAL UNIT DOES NOT RESPOND TO SELECTION
4	08	00	LOGICAL UNIT COMMUNICATION FAILURE
4	08	01	LOGICAL UNIT COMMUNICATION TIMEOUT
4	08	02	LOGICAL UNIT COMMUNICATION PARITY ERROR
4	08	03	LOGICAL UNIT COMMUNICATION CRC ERROR (ULTRA-DMA/32)
4	09	00	TRACK FOLLOWING ERROR
4	09	01	TRACKING SERVO FAILURE
4	09	02	FOCUS SERVO FAILURE
4	09	03	SPINDLE SERVO FAILURE
4	09	04	HEAD SELECT FAULT
4	15	00	RANDOM POSITIONING ERROR
4	15	01	MECHANICAL POSITIONING ERROR
4	1B	00	SYNCHRONOUS DATA TRANSFER ERROR
4	3B	16	MECHANICAL POSITIONING OR CHANGER ERROR
4	3E	01	LOGICAL UNIT FAILURE
4	3E	02	TIMEOUT ON LOGICAL UNIT
4	40	NN	DIAGNOSTIC FAILURE ON COMPONENT NN (80H-FFH)
4	44	00	INTERNAL TARGET FAILURE
4	46	00	UNSUCCESSFUL SOFT RESET
4	47	00	SCSI PARITY ERROR
4	4A	00	COMMAND PHASE ERROR
4	4B	00	DATA PHASE ERROR
4	4C	00	LOGICAL UNIT FAILED SELF-CONFIGURATION
4	53	00	MEDIA LOAD OR EJECT FAILED
1	5D	01	FAILURE PREDICTION THRESHOLD EXCEEDED – Predicted Media failure
1	5D	02	LOGICAL UNIT FAILURE PREDICTION THRESHOLD EXCEEDED
1	5D	03	FAILURE PREDICTION THRESHOLD EXCEEDED – Predicted Spare Area Exhaustion
1	5D	FF	FAILURE PREDICTION THRESHOLD EXCEEDED (FALSE)
4	65	00	VOLTAGE FAULT

F.3.9 Errors Associated with non-ATAPI Environments

Table F.9 — Errors Associated with non-ATAPI Environments

SK	ASC	ASCQ	Description
B	00	06	I/O PROCESS TERMINATED
5	07	00	MULTIPLE PERIPHERAL DEVICES SELECTED
4	08	03	LOGICAL UNIT COMMUNICATION CRC ERROR (ULTRA-DMA/32)
4	09	04	HEAD SELECT FAULT
1	0B	00	WARNING
1	0B	01	WARNING – SPECIFIED TEMPERATURE EXCEEDED
1	0B	02	WARNING – ENCLOSURE DEGRADED
4	1B	00	SYNCHRONOUS DATA TRANSFER ERROR
5	25	00	LOGICAL UNIT NOT SUPPORTED
6	2A	03	RESERVATIONS PREEMPTED
5	2B	00	COPY CANNOT EXECUTE SINCE INITIATOR CANNOT DISCONNECT
6	2F	00	COMMANDS CLEARED BY ANOTHER INITIATOR
	34	00	ENCLOSURE FAILURE
	35	00	ENCLOSURE SERVICES FAILURE
	35	01	UNSUPPORTED ENCLOSURE FUNCTION
	35	02	ENCLOSURE SERVICES UNAVAILABLE
	35	03	ENCLOSURE SERVICES TRANSFER FAILURE
	35	04	ENCLOSURE SERVICES TRANSFER REFUSED
5	3D	00	INVALID BITS IN IDENTIFY MESSAGE
5	43	00	MESSAGE ERROR
B	45	00	SELECT OR RESELECT FAILURE
4	47	00	SCSI PARITY ERROR
B	48	00	INITIATOR DETECTED ERROR MESSAGE RECEIVED
B	49	00	INVALID MESSAGE ERROR
4	4A	00	COMMAND PHASE ERROR
4	4B	00	DATA PHASE ERROR
B	4D	NN	TAGGED OVERLAPPED COMMANDS (NN = QUEUE TAG)

F.3.10 Drive Sense Key, ASC and ASCQ Assignments

Table F.10 — Drive Sense Key, ASC and ASCQ Assignments

SK	ASC	ASCQ	Description
0	00	00	NO ADDITIONAL SENSE INFORMATION
B	00	06	I/O PROCESS TERMINATED
0	00	11	AUDIO PLAY OPERATION IN PROGRESS
0	00	12	AUDIO PLAY OPERATION PAUSED
0	00	13	AUDIO PLAY OPERATION SUCCESSFULLY COMPLETED
0	00	14	AUDIO PLAY OPERATION STOPPED DUE TO ERROR
0	00	15	NO CURRENT AUDIO STATUS TO RETURN
4	00	17	CLEANING REQUESTED
3	02	00	NO SEEK COMPLETE
2	04	00	LOGICAL UNIT NOT READY, CAUSE NOT REPORTABLE
2	04	01	LOGICAL UNIT IS IN PROCESS OF BECOMING READY
2	04	02	LOGICAL UNIT NOT READY, INITIALIZING CMD. REQUIRED
2	04	03	LOGICAL UNIT NOT READY, MANUAL INTERVENTION REQUIRED
2	04	04	LOGICAL UNIT NOT READY, FORMAT IN PROGRESS
2	04	07	LOGICAL UNIT NOT READY, OPERATION IN PROGRESS
2	04	08	LOGICAL UNIT NOT READY, LONG WRITE IN PROGRESS
2	04	09	WRITE ERROR RECOVERY NEEDED
4	05	00	LOGICAL UNIT DOES NOT RESPOND TO SELECTION
3	06	00	NO REFERENCE POSITION FOUND
5	07	00	MULTIPLE PERIPHERAL DEVICES SELECTED
4	08	00	LOGICAL UNIT COMMUNICATION FAILURE
4	08	01	LOGICAL UNIT COMMUNICATION TIMEOUT
4	08	02	LOGICAL UNIT COMMUNICATION PARITY ERROR
4	08	03	LOGICAL UNIT COMMUNICATION CRC ERROR (ULTRA-DMA/32)
4	09	00	TRACK FOLLOWING ERROR
4	09	01	TRACKING SERVO FAILURE
4	09	02	FOCUS SERVO FAILURE
4	09	03	SPINDLE SERVO FAILURE
4	09	04	HEAD SELECT FAULT
6	0A	00	ERROR LOG OVERFLOW
1	0B	00	WARNING
1	0B	01	WARNING – SPECIFIED TEMPERATURE EXCEEDED

Table F.10 — Drive Sense Key, ASC and ASCQ Assignments (continued)

SK	ASC	ASCQ	Description
1	0B	02	WARNING – ENCLOSURE DEGRADED
3	0C	00	WRITE ERROR
3	0C	07	WRITE ERROR – RECOVERY NEEDED
3	0C	08	WRITE ERROR – RECOVERY FAILED
3	0C	09	WRITE ERROR – LOSS OF STREAMING
3	0C	0A	WRITE ERROR – PADDING BLOCKS ADDED
3	11	00	UNRECOVERED READ ERROR
3	11	01	READ RETRIES EXHAUSTED
3	11	02	ERROR TOO LONG TO CORRECT
3	11	05	L-EC UNCORRECTABLE ERROR
3	11	06	CIRC UNRECOVERED ERROR
3	11	0F	ERROR READING UPC/EAN NUMBER
3	11	10	ERROR READING ISRC NUMBER
B	11	11	READ ERROR – LOSS OF STREAMING
3 or 4	15	00	RANDOM POSITIONING ERROR
3 or 4	15	01	MECHANICAL POSITIONING ERROR
3	15	02	POSITIONING ERROR DETECTED BY READ OF MEDIUM
1	17	00	RECOVERED DATA WITH NO ERROR CORRECTION APPLIED
1	17	01	RECOVERED DATA WITH RETRIES
1	17	02	RECOVERED DATA WITH POSITIVE HEAD OFFSET
1	17	03	RECOVERED DATA WITH NEGATIVE HEAD OFFSET
1	17	04	RECOVERED DATA WITH RETRIES AND/OR CIRC APPLIED
1	17	05	RECOVERED DATA USING PREVIOUS SECTOR ID
1	17	07	RECOVERED DATA WITHOUT ECC – RECOMMEND REASSIGNMENT
1	17	08	RECOVERED DATA WITHOUT ECC – RECOMMEND REWRITE
1	17	09	RECOVERED DATA WITHOUT ECC – DATA REWRITTEN
1	18	00	RECOVERED DATA WITH ERROR CORRECTION APPLIED
1	18	01	RECOVERED DATA WITH ERROR CORR. & RETRIES APPLIED
1	18	02	RECOVERED DATA – DATA AUTO-REALLOCATED
1	18	03	RECOVERED DATA WITH CIRC
1	18	04	RECOVERED DATA WITH L-EC
1	18	05	RECOVERED DATA – RECOMMEND REASSIGNMENT
1	18	06	RECOVERED DATA – RECOMMEND REWRITE

Table F.10 — Drive Sense Key, ASC and ASCQ Assignments (continued)

SK	ASC	ASCQ	Description
1	18	08	RECOVERED DATA WITH LINKING
5	1A	00	PARAMETER LIST LENGTH ERROR
4	1B	00	SYNCHRONOUS DATA TRANSFER ERROR
A	1D	00	MISCOMPARE DURING VERIFY OPERATION
5	20	00	INVALID COMMAND OPERATION CODE
5	21	00	LOGICAL BLOCK ADDRESS OUT OF RANGE
5	21	01	INVALID ELEMENT ADDRESS
5	21	02	INVALID ADDRESS FOR WRITE
5	24	00	INVALID FIELD IN CDB
5	25	00	LOGICAL UNIT NOT SUPPORTED
5	26	00	INVALID FIELD IN PARAMETER LIST
5	26	01	PARAMETER NOT SUPPORTED
5	26	02	PARAMETER VALUE INVALID
5	26	03	THRESHOLD PARAMETERS NOT SUPPORTED
5	26	04	INVALID RELEASE OF ACTIVE PERSISTENT RESERVATION
7	27	00	WRITE PROTECTED
7	27	01	HARDWARE WRITE PROTECTED
7	27	02	LOGICAL UNIT SOFTWARE WRITE PROTECTED
7	27	03	ASSOCIATED WRITE PROTECT
7	27	04	PERSISTENT WRITE PROTECT
7	27	05	PERMANENT WRITE PROTECT
7	27	06	CONDITIONAL WRITE PROTECT
6	28	00	NOT READY TO READY CHANGE, MEDIUM MAY HAVE CHANGED
6	28	01	IMPORT OR EXPORT ELEMENT ACCESSED
6	29	00	POWER ON, RESET, OR BUS DEVICE RESET OCCURRED
6	29	01	POWER ON OCCURRED
6	29	02	SCSI BUS RESET OCCURRED
6	29	03	BUS DEVICE RESET FUNCTION OCCURRED
6	29	04	DEVICE INTERNAL RESET
6	2A	00	PARAMETERS CHANGED
6	2A	01	MODE PARAMETERS CHANGED
6	2A	02	LOG PARAMETERS CHANGED
6	2A	03	RESERVATIONS PREEMPTED

Table F.10 — Drive Sense Key, ASC and ASCQ Assignments (continued)

SK	ASC	ASCQ	Description
5	2B	00	COPY CANNOT EXECUTE SINCE INITIATOR CANNOT DISCONNECT
5	2C	00	COMMAND SEQUENCE ERROR
5	2C	03	CURRENT PROGRAM AREA IS NOT EMPTY
5	2C	04	CURRENT PROGRAM AREA IS EMPTY
6	2E	00	INSUFFICIENT TIME FOR OPERATION
6	2F	00	COMMANDS CLEARED BY ANOTHER INITIATOR
2	30	00	INCOMPATIBLE MEDIUM INSTALLED
2	30	01	CANNOT READ MEDIUM – UNKNOWN FORMAT
2	30	02	CANNOT READ MEDIUM – INCOMPATIBLE FORMAT
2	30	03	CLEANING CARTRIDGE INSTALLED
2	30	04	CANNOT WRITE MEDIUM – UNKNOWN FORMAT
2	30	05	CANNOT WRITE MEDIUM – INCOMPATIBLE FORMAT
2	30	06	CANNOT FORMAT MEDIUM – INCOMPATIBLE MEDIUM
2	30	07	CLEANING FAILURE
5	30	08	CANNOT WRITE – APPLICATION CODE MISMATCH
5	30	09	CURRENT SESSION NOT FIXATED FOR APPEND
5	30	10	MEDIUM NOT FORMATTED
2	30	11	CANNOT WRITE MEDIUM – UNSUPPORTED MEDIUM VERSION
3	31	00	MEDIUM FORMAT CORRUPTED
3	31	01	FORMAT COMMAND FAILED
3	31	02	ZONED FORMATTING FAILED DUE TO SPARE LINKING
	34	00	ENCLOSURE FAILURE
	35	00	ENCLOSURE SERVICES FAILURE
	35	01	UNSUPPORTED ENCLOSURE FUNCTION
	35	02	ENCLOSURE SERVICES UNAVAILABLE
	35	03	ENCLOSURE SERVICES TRANSFER FAILURE
	35	04	ENCLOSURE SERVICES TRANSFER REFUSED
1	37	00	ROUNDED PARAMETER
5	39	00	SAVING PARAMETERS NOT SUPPORTED
2	3A	00	MEDIUM NOT PRESENT
2	3A	01	MEDIUM NOT PRESENT – TRAY CLOSED
2	3A	02	MEDIUM NOT PRESENT – TRAY OPEN
6	3B	0D	MEDIUM DESTINATION ELEMENT FULL

Table F.10 — Drive Sense Key, ASC and ASCQ Assignments (continued)

SK	ASC	ASCQ	Description
----	-----	------	-------------

6	3B	0E	MEDIUM SOURCE ELEMENT EMPTY
6	3B	0F	END OF MEDIUM REACHED
6	3B	11	MEDIUM MAGAZINE NOT ACCESSIBLE
6	3B	12	MEDIUM MAGAZINE REMOVED
6	3B	13	MEDIUM MAGAZINE INSERTED
6	3B	14	MEDIUM MAGAZINE LOCKED
6	3B	15	MEDIUM MAGAZINE UNLOCKED
4	3B	16	MECHANICAL POSITIONING OR CHANGER ERROR
5	3D	00	INVALID BITS IN IDENTIFY MESSAGE
2	3E	00	LOGICAL UNIT HAS NOT SELF-CONFIGURED YET
4	3E	01	LOGICAL UNIT FAILURE
4	3E	02	TIMEOUT ON LOGICAL UNIT
6	3F	00	TARGET OPERATING CONDITIONS HAVE CHANGED
6	3F	01	MICROCODE HAS BEEN CHANGED
6	3F	02	CHANGED OPERATING DEFINITION
6	3F	03	INQUIRY DATA HAS CHANGED
4	40	NN	DIAGNOSTIC FAILURE ON COMPONENT NN (80H-FFH)
5	43	00	MESSAGE ERROR
4	44	00	INTERNAL TARGET FAILURE
B	45	00	SELECT OR RESELECT FAILURE
4	46	00	UNSUCCESSFUL SOFT RESET
4	47	00	SCSI PARITY ERROR
B	48	00	INITIATOR DETECTED ERROR MESSAGE RECEIVED
B	49	00	INVALID MESSAGE ERROR
4	4A	00	COMMAND PHASE ERROR
4	4B	00	DATA PHASE ERROR
4	4C	00	LOGICAL UNIT FAILED SELF-CONFIGURATION
B	4D	NN	TAGGED OVERLAPPED COMMANDS (NN = QUEUE TAG)
B	4E	00	OVERLAPPED COMMANDS ATTEMPTED
3	51	00	ERASE FAILURE
3	51	01	ERASE FAILURE – INCOMPLETE ERASE OPERATION DETECTED
4	53	00	MEDIA LOAD OR EJECT FAILED
5	53	02	MEDIUM REMOVAL PREVENTED

Table F.10 — Drive Sense Key, ASC and ASCQ Assignments (continued)

SK	ASC	ASCQ	Description
5	55	00	SYSTEM RESOURCE FAILURE

3	57	00	UNABLE TO RECOVER TABLE-OF-CONTENTS
6	5A	00	OPERATOR REQUEST OR STATE CHANGE INPUT
6	5A	01	OPERATOR MEDIUM REMOVAL REQUEST
6	5A	02	OPERATOR SELECTED WRITE PROTECT
6	5A	03	OPERATOR SELECTED WRITE PERMIT
6	5B	00	LOG EXCEPTION
6	5B	01	THRESHOLD CONDITION MET
6	5B	02	LOG COUNTER AT MAXIMUM
6	5B	03	LOG LIST CODES EXHAUSTED
1	5D	01	FAILURE PREDICTION THRESHOLD EXCEEDED – Predicted Media failure
1	5D	02	LOGICAL UNIT FAILURE PREDICTION THRESHOLD EXCEEDED
1	5D	03	FAILURE PREDICTION THRESHOLD EXCEEDED – Predicted Spare Area Exhaustion
1	5D	FF	FAILURE PREDICTION THRESHOLD EXCEEDED (FALSE)
6	5E	00	LOW POWER CONDITION ON
6	5E	01	IDLE CONDITION ACTIVATED BY TIMER
6	5E	02	STANDBY CONDITION ACTIVATED BY TIMER
6	5E	03	IDLE CONDITION ACTIVATED BY COMMAND
6	5E	04	STANDBY CONDITION ACTIVATED BY COMMAND
5	63	00	END OF USER AREA ENCOUNTERED ON THIS TRACK
5	63	01	PACKET DOES NOT FIT IN AVAILABLE SPACE
5	64	00	ILLEGAL MODE FOR THIS TRACK
5	64	01	INVALID PACKET SIZE
4	65	00	VOLTAGE FAULT
5	6F	00	COPY PROTECTION KEY EXCHANGE FAILURE – AUTHENTICATION FAILURE
5	6F	01	COPY PROTECTION KEY EXCHANGE FAILURE – KEY NOT PRESENT
5	6F	02	COPY PROTECTION KEY EXCHANGE FAILURE –KEY NOT ESTABLISHED
5	6F	03	READ OF SCRAMBLED SECTOR WITHOUT AUTHENTICATION
5	6F	04	MEDIA REGION CODE IS MISMATCHED TO LOGICAL UNIT REGION
5	6F	05	LOGICAL UNIT REGION MUST BE PERMANENT/REGION RESET COUNT ERROR
3	72	00	SESSION FIXATION ERROR

Table F.10 — Drive Sense Key, ASC and ASCQ Assignments (continued)

SK	ASC	ASCQ	Description
3	72	01	SESSION FIXATION ERROR WRITING LEAD-IN
3	72	02	SESSION FIXATION ERROR WRITING LEAD-OUT

5	72	03	SESSION FIXATION ERROR – INCOMPLETE TRACK IN SESSION
5	72	04	EMPTY OR PARTIALLY WRITTEN RESERVED TRACK
5	72	05	NO MORE TRACK RESERVATIONS ALLOWED
3	73	00	CD CONTROL ERROR
1	73	01	POWER CALIBRATION AREA ALMOST FULL
3	73	02	POWER CALIBRATION AREA IS FULL
3	73	03	POWER CALIBRATION AREA ERROR
3	73	04	PROGRAM MEMORY AREA UPDATE FAILURE
3	73	05	PROGRAM MEMORY AREA IS FULL
1	73	06	RMA/PMA IS ALMOST FULL
8	--	--	BLANK CHECK

Note 35. All table values are hexadecimal.

Note 36. All ASC values 80h through FFh are vendor specific.

Note 37. All ASCQ values 80h through FFh are vendor specific.

Annex G Event Reporting Using GESN (Informative)

G.1 Introduction

The GET EVENT STATUS NOTIFICATION command applies to all MM devices.

The proper implementation of this command, together with operating system support, may result in improved autorun time, better user interface results, better time estimates for long operations, and many other user benefits.

G.2 Functional Behavior Guidelines

Requests for a Notification Class of zero should return an event header with the NEA bit set, the Notification Class field set to 000b, and the Supported Event Classes byte set to reflect all N supported Event Classes.

Requests may arrive at the device from an Initiator requesting any subset of events that the device supports. e.g., if { OpChange, DeviceBusy, Media } events are supported, then any of the following events may be requested by the Initiator by a single command block:

```

{ OpChange },
{ Media },
{ OpChange, Media },
{ OpChange, DeviceBusy, Media },
{ DeviceBusy },
{ OpChange, DeviceBusy },
{ DeviceBusy, Media }
```

The data reported by the Drive to the Initiator should contain exactly one Event Class.

The data reported by the Drive to the Initiator should contain an Event Class that was requested by the Initiator in the command block.

The data reported by the Drive to the Initiator should not report a higher priority Event Class if the Event Class was not requested by the Initiator. If multiple Event Classes are requested by the Initiator in a single command block, the Drive should follow the following procedure to determine the Event Class to report to the Initiator. For each requested Event Class, in order of priority per the specification:

1. If an event other than a NoChange event exists, report it.
2. If only NoChange events exist, report highest priority NoChange event.

The Drive should simultaneously support (or queue) at least one event of each Event Class it supports. This prevents events of different Event Classes from interfering with each other.

e.g., if a Media Event and External Request event both occur at the same time, and the Initiator is continuously requesting both event types, then the Drive should:

1. Store both events.
2. Report the External Request event first (higher priority).
3. Clear the External Request event.
4. Not clear the Media Event upon reporting the External Request event.
5. Report the Media Event upon the next GET EVENT STATUS NOTIFICATION request.

To support such behavior early, the following high-level design to support GET EVENT STATUS NOTIFICATION should be considered. This does not preclude other implementations if the device behaves as expected by the operating system.

1. For each supported Event Class, have a queue of appropriate depth (typically 1) of events for that Event Class. For Drives that support the Mt. Rainier format, the minimum appropriate queue depth is 2, and special handling should be given to both the BGFormatCompleted and BGFormatRestarted Media Events.
2. To implement this more simply, and to avoid queue depths greater than one, logically use a queue depth of 1 for the Media Events unless one of the BGFormat events is supported. When an event is generated by the device, the device looks to see if the new event is of greater priority than the current event that is stored of that class. If it is, the new event replaces the existing event in the 1-deep queue for that Event Class. Otherwise, the new event is discarded.

Annex H Power Management (Informative)

H.1 Power Management States

Four power states are defined. These are named Active, Idle, Standby, and Sleep with Active being the “Full-On” state, Sleep the “Off” state and “Idle, Standby and Sleep” progressively more aggressive power managed states. This model differs significantly from previous ATA and SCSI power management definitions. This new model (Table I.1) defines power states in terms of the perceived impact on the end user, instead of absolute power levels. The Idle state is optimized for minimal end user performance impact. The Standby state is optimized for power savings.

To provide consistent behavior across Drives, standard definitions are used for the power states of Drives. These states are defined in terms of the following criteria.

- Power Consumption: How much power the Drive uses.
- Drive Context: How much of the internal state of the Drive is retained by hardware and what is to be restored by the responsible software.
- Restore time: How long it takes to raise the power level to the active power state and to put the Drive into operational condition (including mechanical operation such as spin up) required before entering into the Active power state. Restoring is vendor specific and any mechanism may be employed here to raise the power consumption and to put the Drive in operation condition required in a higher power state. e.g., “turning on or raising internal Vcc for power hungry circuits such as motors, laser sensors,” “raising internal Vcc or the clock frequency for the digital circuits,” etc. A critical factor is how quickly restoring the Drive to operation condition required in a higher power state (e.g. spin up).
- De-power time: How long it takes to reduce the power to the desired level in lower power state after entering the lower power state from higher power state. De-powering is vendor specific and any mechanism may be employed here to reduce the power consumption. e.g., “turning off or lowering internal Vcc for power hungry circuits such as motors, laser sensors,” “lowering internal Vcc or reducing the clock frequency for the digital circuits,” “dynamic clock gating,” “cutting off the DC paths for unused circuits,” “turning off PLLs,” etc.

Table I.1 — Power Management Model States

Drive State	Power Consumption	Drive Context Retained	Restore Time
Active	As needed for operation	All	None
Idle	Less than Active	All	The Drive should be restored to active state within 1 second on any request to enter active state, independent of the de-powering process.
Standby	Less than idle	All buffers are empty before entering Standby state.	Vendor specific: Greater than or equal to Idle to Active
Sleep	Less than Standby	None, Buffer & All of command queues are empty before entering Sleep state.	Greater than or equal to Standby to Active. Vendor Specific. May Need full initialization. The Initiator may remove Vcc.

Transitions between these power states may occur at the request of the Initiator or the Drive. Transitions to a higher power state from a lower power state should occur after restoring the Drive to the operating conditions (including mechanical operation if applicable, such as spin up) required in the higher power state. When the Drive transitions from a higher power state to a lower power state, the Drive should be considered to be in the lower power state when the Drive is assured of reaching the lower power condition. Actual de-powering occurs after the Drive enters the lower power state. The Drive should generate a power event when the Drive is considered to have entered a power state.

In order to create a robust power management environment, Drives should support the following:

- Four power states: Active, Idle, Standby, and Sleep.
- Idle Timer. Provides a method for the Drive to enter Idle state from Active state, following a programmed period of inactivity.
- Standby Timer. Provides a method for the Drive to enter Standby state from either Active or Idle state, following a programmed period of inactivity.
- START STOP UNIT command and the Power Condition Field. Provides a method for the Initiator to request the Drive to enter a power state.
- GET EVENT STATUS NOTIFICATION command. Notifies the Initiator of power state changes and current power status.
- Power Condition mode page. Enables or disables timers and specifies the reload value of the Idle and Standby timers.

H.2 Power State Transitions

Active State:

The Drive is completely active and responsive. The Drive is consuming its highest level of power. During the execution of a media access command (commands that reload both timers) the Drive should be in active state.

The Drive should minimize power consumption at all times, even when in the active state. Any mechanism may be employed, as long as it is transparent to software and does not prevent the Drive from performing expected functions.

e.g., the Drive may dynamically gate on/off internal clocks by monitoring bus activities and internal activities.

Idle State:

In Idle state, the Drive is capable of responding to commands but may take up to one second longer to complete commands than the Active state. The Drive is consuming less power than the Active state. Any mechanism may be employed as long as the restoring time is less than one second. The Drive may, e.g.:

- Reduce internal clock frequency
- Lower the internal Vcc for digital circuits
- Dynamically gate internal clocks by monitoring bus/internal activities

Standby State:

In Standby state the Drive should only be required to accept commands from the Initiator. All other mechanisms are in the power save condition. In Standby state, the Drive is capable of responding to commands but the Drive takes longer to complete commands than when in Idle state. Buffers should be emptied before entering into Standby state. The Drive context should be preserved. The Drive is consuming less power than when in Idle state.

Sleep State:

Maximum power saving state. Buffers and all command queues, including GET EVENT STATUS NOTIFICATION commands, should be emptied before entering into the Sleep state. When the Drive enters the sleep state, any GET EVENT STATUS NOTIFICATION commands present in the command queue, should be removed from the command queue, without command completion. In this Sleep state, all functions are stopped and no commands, except for reset may be received. The unit is consuming less power than when in the Standby state. The Drive context is invalid in the Sleep state.

The Initiator software should fully initialize the Drive after exiting Sleep state, as all context may be lost in the Sleep state. Most devices provide a manual eject mechanism for removing/inserting a disc independent of any lock/unlock mechanism employed. Given this possibility, when the Logical

Unit is unable to determine if media has been changed while the Drive was in the sleep state, the Drive should report NEW MEDIA on the next GET EVENT STATUS NOTIFICATION (Media Status) command.

In the Sleep state, the Initiator may completely remove power from the device by turning off Vcc.

H.3 Power Management State Diagram

The state diagram,

Figure I.1 defines state transitions for the power management model.

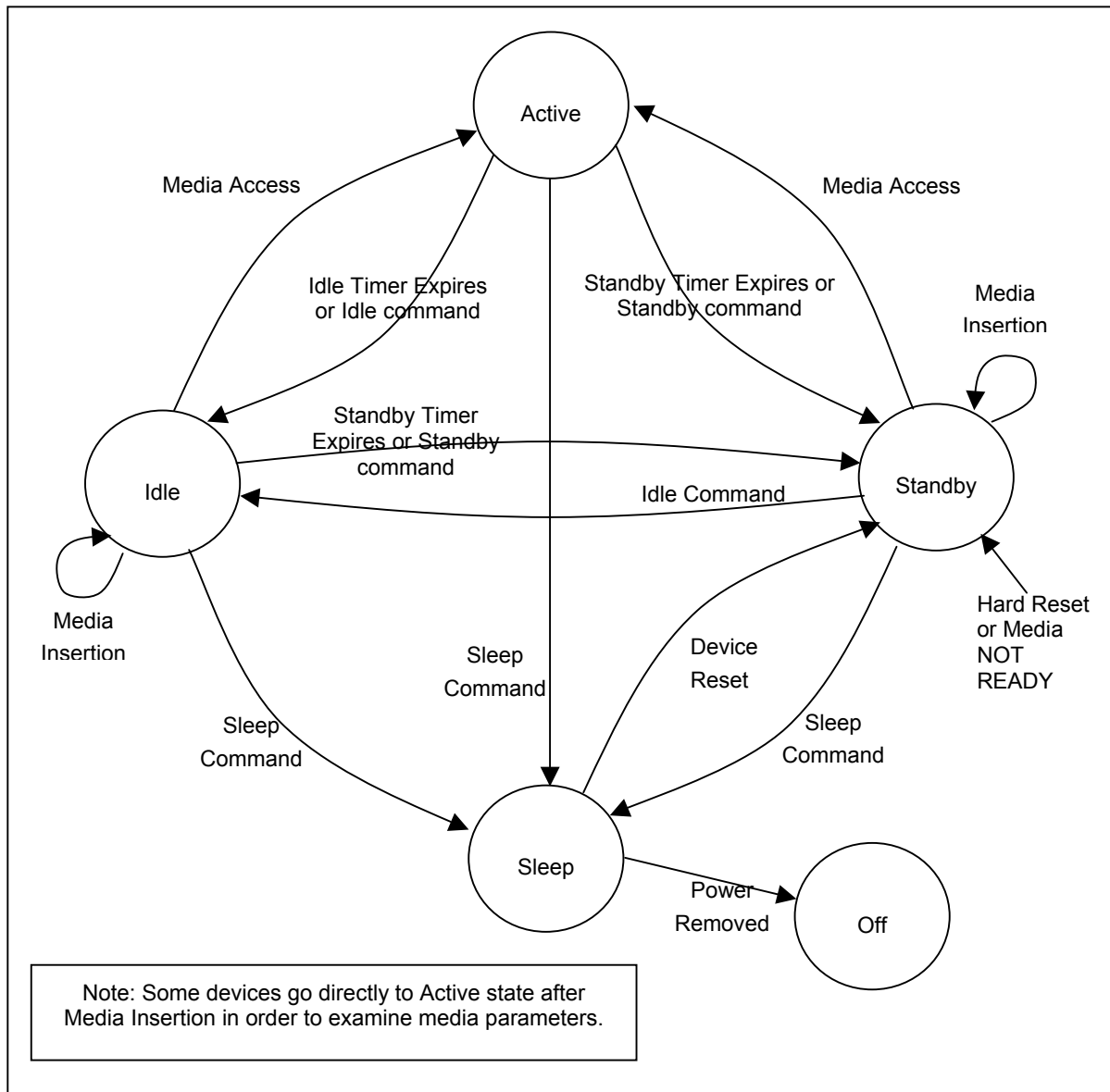

Figure I.1 — Power Management STATE Diagram

A power-on or hard reset always returns the Power State to the Standby State. A Device Reset does not alter the current Power State, unless the current Power State is Sleep. A Device Reset received while in sleep state returns the Power State to Standby.

The Sleep state is entered when the Drive has been commanded to go to Sleep but Vcc is still applied to the device. Removing Vcc always takes the device to the Power Off State. Removing Vcc is recommended only when all Drives on a given bus are in Sleep State.

Table I.2 shows transition conditions for this model, and shows the Initial state, the Resultant state, Notification class, and Event class (Media or Power Management). Notification class and Event class (Power Event/Media Event) fields specify the events that should be generated during the transitions as outlined in the GET EVENT STATUS NOTIFICATION command.

In Idle or Standby states, the Drive should attempt to maintain the minimal power level for that state at all times. However, the Drive may create transitory, higher power level conditions as needed. The transitory power conditions should not affect the reported power state, or generate power state events. Example transitory conditions are: flushing the buffers, emptying command queues, media insertion spin up, or auto off-line, etc. On insertion of new media, the Drive may enter a transitory, higher power condition and stay in this condition for vendor specific time period. If the Drive has not received a media access command (commands that reload both timers) during this period, the Drive should return to the normal power level for the current power state. This prevents excessive power consumption while the Initiator is off-line.

It is permissible to enter intermediate states while in transition between states, however, the Drive should not report power change events for the intermediate states. If the Drive fails to enter the target Power State, the Drive should return to the original Power State. Simultaneous expiration of multiple timers, should cause the Drive to enter the lower Power State, and should only report the result of the transition to that state.

When the Drive is reporting NOT READY, the Drive should enter the Standby State.

If a power change event has not been reported to the Initiator, when a new event is generated, the Drive may choose only to report the most recent power event.

H.4 Power Management Timers

The Idle and Standby timers provide a method for the Drive to enter lower power states after an Initiator programmable period of inactivity, without direct Initiator command.

A timer is deactivated (no longer used by the Drive, regardless of Enable / Disable setting provided from the Initiator) when the Drive is in the associated power state or a lower power state.

A timer is both reactivated (the Drive should use the timer if enabled) and reloaded when a Drive transitions to power state higher than the associated timer.

Timers should be reloaded using the current timer value from the Power Condition mode page

Timers should be disabled/enabled as specified in the Power Condition mode page.

Timers should be set to the default condition upon receiving a power-on, or hard reset. The default condition for the Timers should be enabled with the values of the timers vendor specific.

H.5 Standby Timer

If the Standby Timer expires the Drive should attempt to flush all buffers.

If this operation fails, the Drive should remain in the current power state, and the Standby timer is reloaded. If the flush succeeds, the Drive should enter the Standby State.

Table I.2 — State Transition Events and Status

Initial State	Resultant State	Cause of Transition	Notification Class	Event
Active	Active	Unsuccessful Idle, Standby, or Sleep command	Power	PwrChg-Fail
	Idle	Successful completion of Idle command	Power	PwrChg-Succ
	Idle	The expiration of Idle timer	Power	PwrChg-Succ
	Standby	Successful completion of Standby command	Power	PwrChg-Succ
	Standby	The expiration of Standby timer, all Buffers are empty	Power	PwrChg-Succ
	Sleep	Successful completion of Sleep command	Power	PwrChg-Succ
Idle	Idle	Successful completion of Idle command	Power	PwrChg-Succ
	Idle	Unsuccessful Idle, Standby, or Sleep command	Power	PwrChg-Fail
	Idle	Insertion of media and ready to use	Media	New Media
	Standby	The expiration of Standby timer, all buffers are empty	Power	PwrChg-Succ
	Standby	Successful completion of Standby command	Power	PwrChg-Succ
	Sleep	Successful completion of Sleep command	Power	PwrChg-Succ
	Active	Receptions of a command that reloads both timers	Power	PwrChg-Succ
Standby	Standby	Successful completion of Standby command	Power	PwrChg-Succ
	Standby	Unsuccessful Idle, Standby, or Sleep command	Power	PwrChg-Fail
	Standby	Insertion of media and ready to use	Media	NewMedia
	Idle	Successful completion of Idle command	Power	PwrChg-Succ
	Sleep	Successful completion of Sleep command	Power	PwrChg-Succ
	Active	Receptions of a command that reloads both timers	Power	PwrChg-Succ
Any	Standby	A power-on, or hard reset occurred, or the Drive becomes NOT READY	Power	PwrChg-Succ
Sleep	Standby	Device Reset	Power	PwrChg-Succ

Commands issued by the Initiator should have an effect on the timers implemented by the Drive. The effect is defined in Table I.3.

Table I.3 — Effects of Initiator Commands on Timers

Initiator Command Issued	Timer Effects	Comments
BLANK	Reload Both	Recordable only
CHANGE DEFINITION	None	
CLOSE TRACK	Reload Both	Recordable only
COMPARE	Reload Both	SCSI only
EXECUTE LOGICAL UNIT DIAGNOSTIC	Reload Both	ATA command
SYNCHRONIZE CACHE	Reload Both	
FORMAT UNIT	Reload Both	Recordable only
GET CONFIGURATION	None	
GET EVENT STATUS NOTIFICATION	None	
INQUIRY	None	
LOAD/UNLOAD MEDIUM	Reload Both	
LOCK/UNLOCK CACHE	None	SCSI only. A Lock Cache command should prevent the Drive from entering Standby or Sleep states.
LOG SELECT/SENSE	None	SCSI only
MECHANISM STATUS	None	
MODE SELECT	May Reload Timers	A MODE SELECT command that changes the Standby or Idle timers should reload the timer.
MODE SENSE	None	
PLAY AUDIO MSF	Reload Both	
PREFETCH	Reload Both	SCSI only
PREVENT ALLOW MEDIUM REMOVAL	Reload Standby	
READ (12)	Reload Both	
READ BUFFER	Reload Standby	
READ MM CAPACITY	Reload Both	
READ CD	Reload Both	
READ CD MSF	Reload Both	
READ DISC INFORMATION	Reload Both	
READ DISC STRUCTURE	Reload Both	
READ FORMATTABLE CAPACITIES	Reload Standby	
READ LONG	Reload Both	SCSI only
READ TRACK INFORMATION	Reload Both	
READ SUB-CHANNEL	Reload Both	
READ TOC/PMA/ATIP	Reload Both	

Table I.4 — Effects of Initiator Commands on Timers (cont.)

Initiator Command Issued	Timer Effects	Comments
RELEASE	None	SCSI only
REPAIR TRACK	Reload Both	Sequential MM Recordable
REPORT KEY	Reload Both	
GET PERFORMANCE	Reload Both	May need to access media
REQUEST SENSE	None	
RESERVE	None	SCSI only
RESERVE TRACK	Reload Both	Recordable only
REZERO	Reload Both	SCSI only
SCAN	Reload Both	
SEEK	Reload Both	
SEND EVENT	Reload Both	May effect media access
SEND KEY	Reload Both	
SEND DISC STRUCTURE	Reload Both	DVD Recordable
SEND OPC INFORMATION	Reload Both	Recordable only
SET CD SPEED	Reload Both	Obsolete
SET READ AHEAD	Reload Both	
SET STREAMING	Reload Both	
START STOP UNIT	See Start Stop Unit command	
TEST UNIT READY	Reload Both	
VERIFY	Reload Both	
WRITE	Reload Both	Recordable only
WRITE AND VERIFY (10)	Reload Both	Recordable only
Device Reset	Reload Both	Reset operation, the Drive should not return to default timer conditions.
Other commands	Vendor Specific	

H.6 Power Management Status Reporting

The POWER STATUS field of the GET EVENT STATUS NOTIFICATION (Power Management Class) event data should always report the current Drive power state. This provides a mechanism for the Initiator to query the current Power State, irrespective of state transitions.

END